

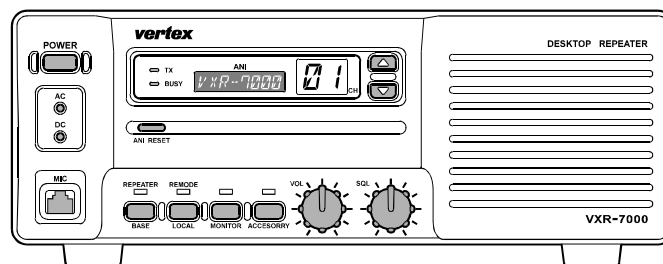

VXR-7000

Operating Manual



Vertex Standard LMR, Inc.

4-8-8 Nakameguro, Meguro-Ku, Tokyo 153-8644, Japan

Contents

Introduction	1
Controls & Connectors	2
Front Panel	2
Rear Panel	3
ACC Connector Port	4
LINE Interface Port	6
Installation	7
Antenna Considerations	7
DC Power Supply Backup	7
Equipment Location	7
CE27 Programming Software Instruction	8
Channel Data Items	9
Duplexer Installation	12
Specifications	14
Accessories	15

Attention in case of use

This repeater works on frequencies which are not generally permitted.

For frequency allocation, apply for a licence at your local spectrum management authority.

For actual usage contact your dealer or sales shop in order to get your repeater adjusted to the allocated frequency range.

List of the practicable area					
AUT	BEL	BGR	CYP	CZE	DEU
DNK	ESP	EST	FIN	FRA	GBR
GRC	HUN	IRL	ITA	LTU	LUX
LVA	MLT	NLD	POL	PRT	ROM
SVK	SVN	SWE	CHE	ISL	LIE
NOR					

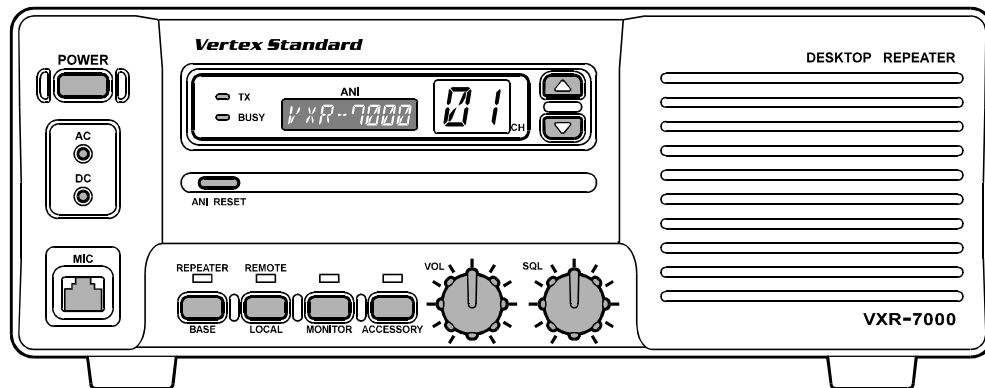

The VXR-7000 is commercial quality 25-watt FM repeater designed to provide reliable, continuous-duty two-way communications over a wide range of environmental conditions.

Designed to be a stylish base station, with high-grade components utilized throughout, the VXR-7000 utilizes the latest computer-aided design and manufacturing processes to ensure a high level of reliability for users. Important channel frequency data is stored in EEPROM, and is easily programmable by a Servicing Technician or Dealer using an IBM compatible personal computer and the FIF-10A (or FIF-12) + CT-104A USB Programming Interface and CE27 Software.

Please take a few minutes to read this manual carefully. The information presented here will allow you to derive maximum performance from your VXR-7000. After reading it, keep this manual handy for quick reference, in case questions arise later on.

Important Note: Internal service work, programming, and accessory installations should only be performed by your authorized Vertex Standard Dealer. Dangerous conditions and/or possibly illegal operation may result from improper setup, programming, or internal modifications.

NOTICE!

- Do not modify this repeater for any reason. Refer service of this repeater to qualified technicians only.
- When the repeater become abnormal, such as the overheating, smoke smell of burning, etc., turn the main power switch off and disconnect the Main Power Source connector from the rear of the **VXR-7000** immediately. Also disconnect any backup power source you may have connected to the rear of the **VXR-7000**.
- Do not place any combustible material near the repeater.
- Do not spray any liquid over the repeater.
- Ensure that the power and antenna connections are securely made, using cables with excess capacity for the power being utilized.

Front Panel

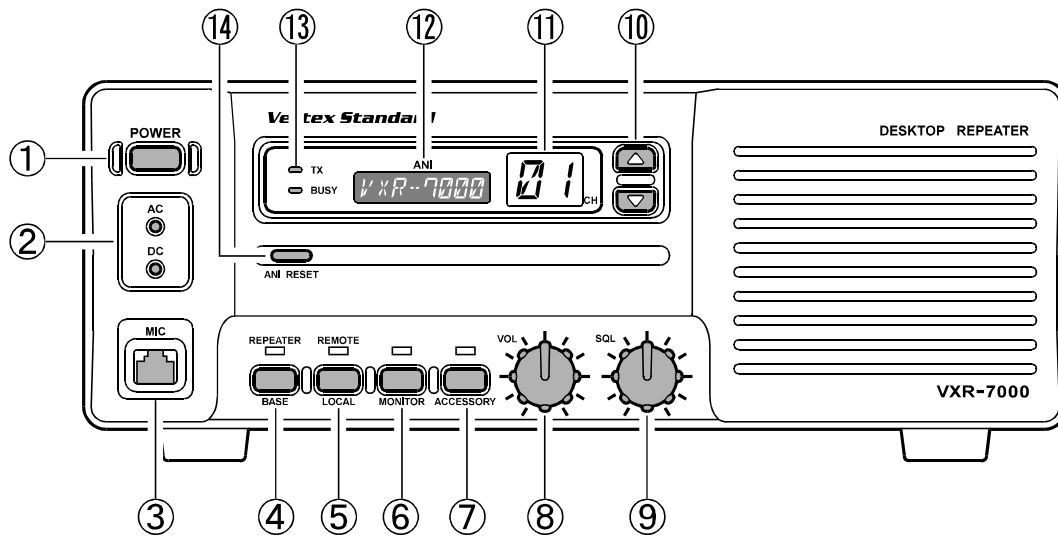

① POWER Switch

This is the main power switch for the repeater.

② LED Indicators

AC: This LED glows green during AC operation.

DC: This LED glows yellow during DC operation.

③ MIC Jack

This 8-pin modular jack accepts the microphone input, and provides a standby control line to activate the transmitter when using the “*BASE*” mode of operation. This jack also provides a “Hook” control line, as well as a “Clone Data” line.

④ BASE/REPEATER Switch

This switch toggles the operating mode between the “*REPEATER*” mode and the “*BASE*” transceiver mode. When the “*REPEATER*” mode is selected, the LED above it glows green. While in the “*BASE*” mode (the green LED is off), you can speak into the microphone to use it as a transceiver. For normal repeater operation, set this switch to the “*REPEATER*” mode.

⑤ LOCAL/REMOTE Switch

This switch toggles the control mode between the “*REMOTE*” mode and “*LOCAL*” mode. When the “*LOCAL*” mode is selected, the LED above it is off, and the repeater operates according to the control data programmed into the repeater. While in the “*REMOTE*” mode, the LED glows green, and the repeater operates according to the control instructions received from an external device (connected to the **ACC** jack on the rear panel).

⑥ MONITOR Switch

This switch selects the “*Squelch*” (receiver mute) mode. When the green LED above it is off, “*Tone*” or “*Coded*” squelch is active. When you press this switch *momentarily*, the green LED will glow steadily; in this condition, only “*noise squelch*” is active, and any signal present on the channel will be heard. If you *press and hold* this switch for more than 2 second, the green LED will blink and the squelch will open; in this condition, background noise will be heard if no signal is present.

⑦ ACCESSORY Switch

This switch can be set up for special applications, such as High/Low power selection, as determined by your Vertex Standard dealer. The LED above it glows green when this function is activated. For further details, contact your Vertex Standard dealer.

⑧ VOL Knob

This control knob adjusts the receiver volume level from the front panel speaker. If desired, this control knob may be set fully counterclockwise when repeater monitoring is not needed.

⑨ SQL Knob

This control knob selects the noise squelch threshold level. Set it to a position just above the point where the BUSY lamp goes out when no signal is present.

⑩ Channel Selector Buttons (▲ and ▼)

Press one of these buttons to select the operating channel.

- ⑪ **Channel Indicator**
This seven-segment LED indicates the operating channel number.
- ⑫ **ANI Display**
The ANI LCD (Liquid Crystal Display) indicates the pre-programmed ANI message according to the ANI code received.
- ⑬ **TX/BUSY Indicator**
The **BUSY** indicator glows green when the channel is busy, and the **TX** indicator glows red when the repeater is transmitting.

- ⑭ **ANI RESET Button**
 - (1) ANI
Press this button to clear the message on the ANI display, and turn off the LCD backlight.
 - (2) ENI
Press this button to turn off the Alert tone. Press this button again to clear the message on the ANI display, and turn off the LCD backlight.

Rear Panel

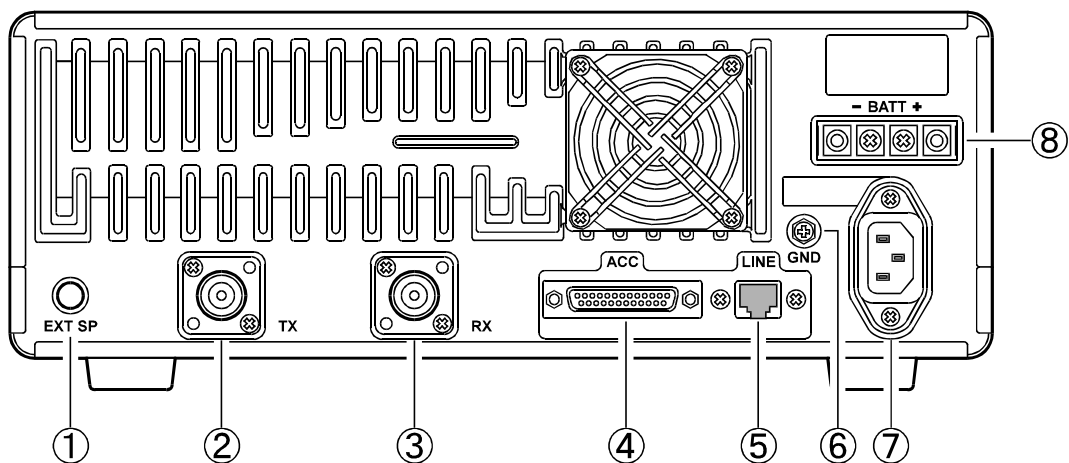

- ① **EXT SP Jack**
This 3.5-mm, 2-pin jack provides variable audio output for an external speaker. The audio output impedance at this jack is $4\ \Omega \sim 16\ \Omega$, and level varies according to the setting of the front panel's **VOL** control.
- ② **TX Antenna Jack**
This N-type coaxial jack provides the transmitting output signal for connection to the transmitting antenna or TX jack on the duplexer, if used. The output impedance requirement is $50\ \Omega$.
Warning! The 50 V RF voltage (@25 W/50 Ω) is applied to the TX RF section of the repeater while transmitting. Do not touch the PA RF section absolutely while transmitting.
- ③ **RX Antenna Jack**
This N-type coaxial jack accepts the receiver input signal from the receiving antenna or RX jack on the duplexer, if used. The input impedance requirement is $50\ \Omega$.
- ④ **ACC Jack**
This DB-25 connector provides a data interface between the microprocessor in the VXR-7000 and peripheral devices (such as the VX-TRUNK Unit).
- ⑤ **LINE Jack**
This 8-pin modular jack is used for remote control. It provides TX and RX audio, TX keying, and squelch status output. The TX and RX audio impedance is $600\ \Omega$.
- ⑥ **GND Terminal**
For best performance and safety, the GND terminal should be connected to a good earth ground using a short, heavy, braided cable.
- ⑦ **AC Jack**
This receptacle accepts the AC power cord, which should be connected to the AC mains supply or wall outlet. The AC line voltage must match that for which the repeater is wired.
- ⑧ **BATT Terminal**
These terminal posts accept 12~15 VDC for operating the repeater from a battery or other DC source. When operating from AC mains, a small trickle current is present at these terminals to maintain battery charge. A battery rated for 12 volts, 55 Ah (minimum) is recommended for short-term emergency/backup operation.
Never short-circuit these terminal while operating from AC mains.

ACC Connector Port

The VXR-7000 repeater is provided with a 25-pin DB-25F female connector for interconnections to accessories. Use a DB-25M 25-pin male connector to connect accessories to the repeater. The pins on the accessory connector are explained in detail as follows:

Pin 1: GND

Chassis ground for all logic levels and power supply return.

Pin 2: +13.8 V [Power Supply]

This pin provides 13.8 Volts, 1.0 A, regulated DC from the repeater supply. Use a 1 A fuse in the external device's DC line to prevent damage to the repeater.

Pin 3: TX AF IN [Analog Transmitter Input]

(Voice Band: 300 ~ 3,000 Hz)

Input impedance is approx. 600 Ω. This audio is injected before the splatter filter stage, so excess signal input levels are clipped.

Use shielded cable to connect to this pin, and connect the shield to **GND**.

Pin 4: TONE IN [Transmitter Input]

(Sub-audible Band: 6 ~ 250 Hz)

The input is high impedance (approx. 22 kΩ). Injecting too high a voltage here causes over-deviation of CTCSS or DCS, degrading performance. Use shielded cable to connect to this pin, connecting the shield to **GND**.

Pin 5: N.C. (No connection.)

Pin 6: DISC OUT [Analog Output]

(Wide-Band: 0 ~ 3,000 Hz)

Received signals with standard deviation produce approx. 1 V_{P-P} audio at this pin. The output impedance is approx. 600 Ω, and is extracted before the de-emphasis and squelch circuitry. Use shielded cable to connect to this pin, and connect the shield to **GND**.

Pin 7: GND

Chassis ground for all logic levels and power supply return.

Pin 8: RSSI [Analog Output]

A DC voltage proportional to the strength of the signal currently being received (**Receiver Signal Strength Indicator**) is provided on this pin. This low impedance output is generated by the receiver IF sub-system and buffered by an internal op-amp. Typical voltages are graphed as follows:

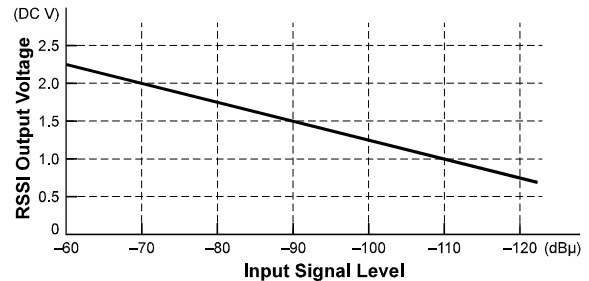

Pin 9: COAX. SW [Logic Output (Active Low)]

This output is intended for controlling an external coaxial switching relay. It is an open collector output which can sink approx. 10 mA when active. This signal only switches if the repeater has been programmed for "SIMPLEX" mode. If programmed for "DUPLEX," the signal remains open (high impedance) at all time.

Pin 10: N.C. (No connection.)

Pin 11: NSQ DET

This is an open-collector, active-low output capable of sinking about 10 mA. It indicates that the receiver squelch is open. If the squelch control is properly set, this indicates a carrier on the receiver channel.

Pin 12: EXT PTT

This input is internally pulled up to 5 VDC. When pulled low by an external device, it keys the repeater transmitter while the repeater is operating in the "BASE" mode. Avoid voltage in excess of 5 V on this pin, or internal damage to the microprocessor on the repeater CNTL Unit may result.

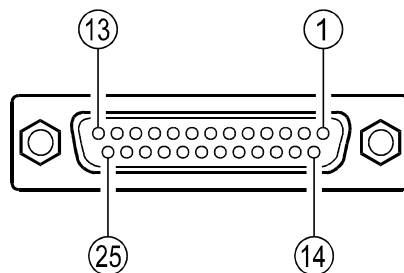

**ACC Jack
DB-25 Pin Numbering**

Pin 13: GND

Chassis ground for all logic levels and power supply return.

Pin 14: GND

Chassis ground for all logic levels and power supply return.

Pin 15: N.C. (No connection.)

Pin 16, 17, 18, & 19: REMOTE CH DATA

[Logic Inputs D3, D2, D1, and D0] (*Active Low*)

These inputs are internally pulled up to 5-V DC. When pulled low by an external device, they select one of the 16 pre-programmed repeater operating channels. The logic truth table below shows the combinations for selecting all 16 channels.

In the truth table, "1" represents no connection, and "0" represents a ground connection on the pin.

The channel selection logic is not inhibited while the transmitter is keyed: the repeater will change frequency when instructed, even while transmitting. Avoid voltage in excess of 5 V on these pins or internal damage to the microprocessor on the repeater CNTL Unit may result.

Channel	Pin 16 (D3)	Pin 17 (D2)	Pin 18 (D1)	Pin 19 (D0)
1	1	1	1	1
2	1	1	1	0
3	1	1	0	1
4	1	1	0	0
5	1	0	1	1
6	1	0	1	0
7	1	0	0	1
8	1	0	0	0
9	0	1	1	1
10	0	1	1	0
11	0	1	0	1
12	0	1	0	0
13	0	0	1	1
14	0	0	1	0
15	0	0	0	1
16	0	0	0	0

Pin 20: GND

Chassis ground for all logic levels and power supply return.

Pin 21: A-OUTPUT [Logic Output] (*Active Low*)

This open collector logic output is pulled low when the front panel's **ACCESSORY** key is turned on. It can sink approx. 10 mA when active.

Pin 22: RXD LOW

[Digital Output for DATA Communications]
(300 ~ 3,000 Hz)

This pin is an output for low speed receiving data signals, with the data being extracted after the de-emphasis and low pass filter stages.

Pin 23: RXD HI

[Digital Output for DATA Communications]

This pin is an output for high speed receiving data signals, with the data being extracted immediately after the discriminator prior to any de-emphasis).

Pin 24: TXD LOW

[Digital Input for DATA Communications]
(300 ~ 3,000 Hz)

This pin is intended to be used as a low speed digital data signal input to the repeater. This digital data signal is injected before transmitter pre-emphasis and limiting stage, so excess signal input levels are clipped.

Pin 25: TXD HI

[Digital Input for the DATA Communications]

This pin is intended to be used as a high speed digital data signal input to the repeater. This digital data signal is injected after transmitter splatter filter stage.

LINE Interface Port

The VXR-7000 is provided with an 8-pin modular jack for line interfacing applications. A Western Electric® modular-type RJ45 plug should be used to connect to this jack. The **LINE** jack pin-out is shown below.

Note that there are both 4-line and 8-line types of modular plugs. If a 4-line modular plug is used, only the **LINE OUT** and **LINE IN** connections will be made. An 8-line plug is required to access all lines. In accordance with standard telecommunications interface, the line connections on the **LINE** interface jack are impedance balanced, and are described as follows.

Pins 1 & 2: [RX SQ(+), RX SQ(-)]

An opto-isolator is provided to facilitate E (EAR) signaling. The opto-isolator comes on when a signal exceeding the receiver squelch appears on the receiver channel (with correct CTCSS tone or DCS code, if enabled). The RX SQ(-) pin is the emitter, and RX SQ(+) is the collector.

Maximum Voltage: 20 V, Maximum Current: 7 mA.

Pins 3 & 4: [LINE IN (Tx Line Audio)]

Analog signals between 300 and 3000 Hz supplied to this pair are fed to the transmitter when the repeater is set to the BASE mode (the **REPEATER** LED is turned off) and keyed either by the TX KEY input signal (see below), or by the EXT PTT signal on pin 12 of the rear panel's **ACC** jack. Standard deviation is obtained with a line level of -10 dBm.

Pins 5 & 6: [LINE OUT (Rx Line Audio)]

Receiver audio is available from this pair, subject to internal CTCSS or DCS decode if the received signal strength is above the squelch threshold.

As shipped from the factory, a 1-kHz receiver signal with standard deviation gives -10 dBm on the line, but this can be varied by **VR4002** and **S4001** (on the repeater's CNTL Unit).

Pins 7 & 8 [TX KEY(+), TX KEY(-)]

An opto-isolator is provided to facilitate M (MIC) signaling. That is, a voltage presented to these pins turns on the opto-isolator and keys the transmitter. The TX KEY(+) pin is the anode of the opto-isolator, and RX SQ(-) is the cathode of the opto-isolator.

Maximum Voltage: 20 V, Maximum Current: 4 mA.

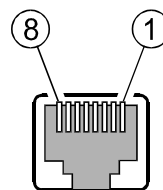

**LINE Jack
Modular Jack Pin Numbering**

Antenna Considerations

Repeater operation without a duplexer requires that two antennas be installed, one for receiving and one for transmitting, so that the receiving antenna does not absorb energy from the transmitting antenna. There are a number of ways to do this, depending on the TX/RX frequency separation, and on the locations available for antenna mounting. If a duplexer is used, a single antenna suffices for both transmitting and receiving. If using a reduced-size duplexer, a six-cavity model (minimum) is recommended. Vertex Standard recommends the use of the duplexer. For further details, contact your Vertex Standard dealer.

Regardless of the above choice, it is of paramount importance that the antenna(s) be mounted as high and in the clear as possible, preferably within line-of-sight to all repeater users. Furthermore, losses in the feedline(s) must be minimized, so the feedline(s) should be high quality, and as short as possible. If a long feedline is necessary, use coaxial "hardline" cable to reduce losses.

Repeater antennas should have an impedance of 50 Ω at the operating frequency. When separate receive and transmit antennas are used, high-Q narrow-band types may serve to minimize interaction. However, when a single antenna is used with a duplexer, it should be a low-Q wide-band type.

NEVER TRANSMIT WITHOUT HAVING A TRANSMIT ANTENNA CONNECTED TO THE TX ANTENNA JACK OF THE REPEATER.

DC Power Supply Backup

For uninterrupted operation during power failures, a 12 volt rechargeable type battery (55-Ah or more recommended) may be connected to the **BATT** terminal posts on the rear panel. While the repeater is operating from the AC source, a slight charging current will maintain battery charge. In the event of an AC power outage, the automatic power control circuit will automatically switch the repeater to the backup battery, and operation will not be interrupted.

After prolonged operation from the battery, it should be disconnected from the repeater and recharged separately before re-connecting, as the trickle charge is not sufficient for recharging a completely discharged battery.

Never reapply AC power to the repeater with a discharged battery connected, as the DC startup current can damage the repeater and battery.

While operating from a battery or DC supply, the repeater requires approximately 7 amperes at 12 Volts during transmit.

Equipment Location

While the operating temperature range of the repeater is quite broad, the best location is one in which the air temperature does not approach the extremes of the specified range, and one that does not change rapidly. Make sure to allow for free air flow around the heatsink on the rear apron at all times. In warm climates, the repeater should not be sealed in a small closed room.

Do not place equipment, books, or papers on top and bottom of the repeater. Also, provide 30 centimeters of space on either side of the repeater.

Protect the repeater from wind and rain, and extremes in temperature or humidity that may shorten the useful life of the equipment. Try to locate the repeater in an environment that is also comfortable for service personnel, if possible.

CE27 Programming Software Instruction

With the CE27 Programming Software, you can quickly and easily program the Vertex Standard VXR-7000 repeater's channels and configuration from your personal computer. Channel data programming format is identical for VHF and UHF repeaters. In the event of an accidental memory failure, repeater memory and configuration data may be re-loaded in a matter of minutes.

Before connecting the VXR-7000 for programming, turn off both the computer and the VXR-7000. Now connect the FIF-10A (or FIF-12) + CT-104A USB Programming Interface to the computer's USB port and the VXR-7000's MIC jack.

Then it will be safe to restart the computer; turning off the equipment during interconnection avoids the potential for damage to the electronics caused by voltage spikes.

Install the CE27 Programming Software onto your computer's hard disk drive.

Browse to where the files were saved on the Hard Drive in above step, then double-click the left mouse button on the "CE27Win.exe" to start the program. The introductory screen will appear.

Choose the "Help" contents option (F1) from the program's Menu for assistance with channel programming or setting of parameters.

Important Note!

- ❑ Do not run the original CE27 programming software directly. Copy the programming software to your computer's hard disk, then run the software from the copied software only. Keep the original software in a safe place in case you need to make another copy of it at a later date.
- ❑ Before creating the programming data for your VXR-7000 via the CE27 programming software, upload the current factory hardware environment data from the VXR-7000, using the [F5] (ReadRom) command. Use this data profile to create the programming data for this repeater.

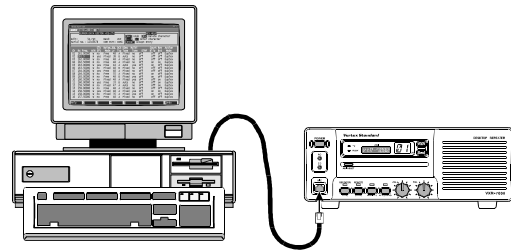

VXR-7000 Programming Setup

Channel Data Items

Ch: Channel Number

This number (1 - 16) is used to identify the channel. Channel numbers occur in sequence, and their order can not be changed.

Double-click the left mouse button on the number to toggle the operation of the channel (except "Ch1").

Rx Freq: Edit Receive (or simplex) Frequency

Use the [0] - [9] keys to enter the desired channel frequency directly, and press the [ENTER] key.

CTCSS Decoders: Toggle CTCSS Decoder ON/OFF, sets CTCSS Frequency

Double-click the left mouse button to display the "Tone Select" window, click the left mouse button on the desired tone, then click the left mouse button on the [OK] switch to accept the selected tone.

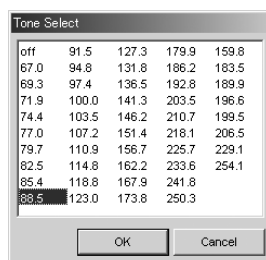

DCS Decoders: Toggle DCS Decoder ON/OFF, sets DCS Code

Double-click the left mouse button to display the "Coded Select" window, click the left mouse button on the desired DCS code, then click the left mouse button on the [OK] switch to accept the selected code.

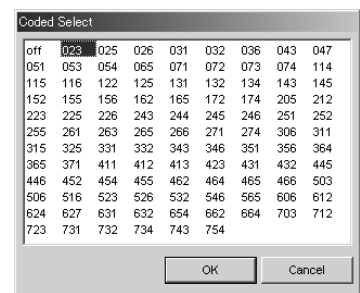

WIN: Wide/Narrow Channel Spacing

This function selects the channel spacing environment in which the VXR-7000 operates.

W (Wide) = 25 kHz Channel Spacing, ±5 kHz Deviation.

N (Narrow) = 12.5 kHz Channel Spacing, ±2.5 kHz Deviation.

Double-click the left mouse button to select the desired channel spacing environment.

CE27 Programming Software Instruction

Channel Data Items

Clk Sft: Enable/disable the CPU Clock Shift

This function is only used to move a spurious response "birdie" should it fall on a current frequency.

Double-click the left mouse button to toggle "yes" or "no."

NSQ Mode: Noise Squelch Mode

This command selects the manner of setting of the Squelch threshold level.

User = The squelch threshold level is fixed via the "NSQ Lv" parameter (NSQ Lv: 0 [min.] ~ 255 [max.]).

Prpgrm = The squelch threshold level determined via the dealer programming.

Double-click the left mouse button to select the desired NSQ Mode.

NSQ Lv: Noise Squelch threshold level

Use the [0] - [9] keys to enter the desired Squelch threshold level directly, and press the [ENTER] key. Available values are 0 (min.) ~ 255 (max.).

Court Blip: Courtesy Blip

Double-click the left mouse button to toggle "on" or "off."

When this parameter is set to "on," this function causes the VXR-7000 to send out a "blip" on the portable/mobile radio is frequency each time the portable radio is unkeyed. This provides audible confirmation to the user that the VXR-7000 was able to receive the transmission from the portable.

Rev Bst: Reverse Burst.

Double-click the left mouse button to toggle "on" or "off."

When this parameter is set to "on," the CTCSS tone signal's phase is inverted just before the repeater turns to receive. This allows the portable/mobile station's CTCSS Decoder to begin switching off, thus reducing the transition time required.

DCS Typ: DCS Format

This command is effective only when DCS is chosen for squelch control.

A = "Normal" DCS

B = "Inverted" (complement) DCS

Double-click the left mouse button to select the desired DCS Type.

Ch	Rx Freq	Decoders			Clk Sft	NSQ		Court Blip	Rev Bst	DCS Typ	DDec Type	Multi Tone	CWID ANI/ENI	Action Mode	Tx
		CTCSS	DCS	W/N		Mode	Lv								
1	161.00000	88.5	off	W	no	Prpgrm	---	off	off	A	Fixed	no	off	Duplex	1
2	161.05000	100.0	off	W	no	Prpgrm	---	off	off	A	Fixed	no	off	Duplex	1
3	161.10000	off	023	W	no	Prpgrm	---	on	off	A	Fixed	no	off	Duplex	1
4	161.15000	off	155	W	yes	Prpgrm	---	off	off	A	Fixed	no	off	Duplex	1
5	161.20000	off	155	W	no	Prpgrm	---	off	off	A	Fixed	no	off	Duplex	1
6	161.25000	88.5	off	W	no	Prpgrm	---	off	off	A	Fixed	no	off	Duplex	1
7	161.30000	114.8	off	W	no	Prpgrm	---	on	on	A	Fixed	no	off	Duplex	1
8	161.35000	off	351	W	no	Prpgrm	---	off	off	A	Fixed	no	off	Duplex	1
9	161.40000	off	506	W	no	Prpgrm	---	off	off	A	Fixed	no	off	Duplex	1
10	161.45000	off	off	W	no	Prpgrm	---	off	off	A	Fixed	no	off	Duplex	1
11	161.50000	100.0	off	W	no	Prpgrm	---	on	on	A	Fixed	no	off	Duplex	1
12	161.55000	88.5	off	W	no	Prpgrm	---	off	off	A	Fixed	no	off	Duplex	1
13	161.60000	103.5	off	W	no	Prpgrm	---	off	off	A	Fixed	no	off	Duplex	1
14	161.65000	off	off	W	yes	Prpgrm	---	off	off	A	Fixed	no	off	Duplex	1
15	161.70000	79.7	off	W	no	Prpgrm	---	on	off	A	Fixed	no	off	Duplex	1
16	161.75000	off	off	W	no	User	48	off	on	A	Fixed	no	off	Duplex	1

CE27 Main Screen (Left)

Channel Data Items

DDec Type: DCS Decoder Type

This command selects the manner in which DCS is to be decoded.

Fixed = Decodes only the type selected in above parameter (DCS Typ: Normal or Inverted).

Auto = Both types (Normal and Inverted) will be decoded.

Double-click the left mouse button to select the desired DCS Decoder Mode.

Multi Tone: Enable/disable Multi Tone Operation

Double-click the left mouse button to display the "Multi Tone" window.

Double-click the left mouse button on the "Multi Tone Enable" to toggle the Multi Tone Operation between selections "yes" (☑) and "no" (☐).

Click the left mouse button on the appropriate field to open the "Drop Down List". Now select the desired CTCSS tone or DCS code. You may set as many as 16 CTCSS tones and/or DCS codes.

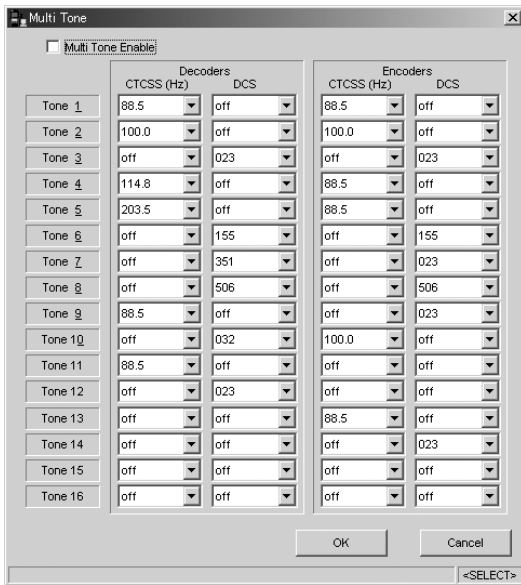

CWID ANI/ENI: Select the Identifier mode

Double-click the left mouse button to toggle the selections "CW ID," "ANI/ENI," or "Off." To select this feature to the "CW ID" or "ANI/ENI," the "CW ID" parameter must be enabled via the dealer programming.

Action Mode: Select the repeater operation mode

Double-click the left mouse button to toggle between "Duplex" operation or "Simplex" operation.

Tx Freq.: Edit Transmit Frequency

Use the [0] - [9] keys to enter the desired channel frequency directly, and press the [ENTER] key.

CTCSS Encoders: Toggle CTCSS Encoder ON/OFF, sets CTCSS Frequency

Double-click the left mouse button to display the "Tone Select" window, click the left mouse button on the desired tone, then click the left mouse button on the [OK] switch to accept the selected tone.

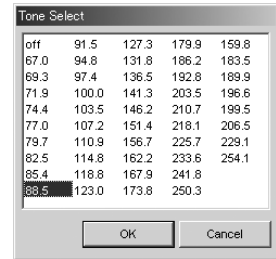

DCS Encoders: Toggle DCS Encoder ON/OFF, sets DCS Code

Double-click the left mouse button to display the "Coded Select" window, click the left mouse button on the desired DCS code, then click the left mouse button on the [OK] switch to accept the selected code.

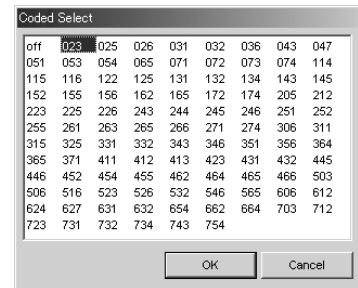

Base TOT: Enable/disable the Time-Out Timer while in the "BASE" station mode

Double-click the left mouse button to toggle the TOT feature selects "yes" and "no." The TOT time is determined via dealer programming.

Base Guard: Enable/disable the Base Guard Feature

Double-click the left mouse button to toggle the Base Guard feature selects "yes" and "no." When this parameter is set to "yes," the transmitter will be inhibited for a few seconds before the repeater (in the "BASE" station mode) turns to receive. The inhibit time is determined via dealer programming.

LOUT: Select the Lock Out Feature's mode

Double-click the left mouse button to toggle the Lock Out Feature between "BCLO," "BTLO," or "off." "BCLO" inhibits transmitting while there is carrier present. "BTLO" inhibits transmitting while there is carrier present unless there also is a valid tone present.

TX Pwr: Transmitter Power Output Selection

This parameter selects the desired power output from the VXR-7000 on the current channel. The available values are HIGH and LOW. Double-click the left mouse button to select "Hi" or "Lo."

Channel Data Items

TOT Mute: Enable/disable the TOT (Time-Out Timer) beep monitoring

Double-click the left mouse button to toggle the TOT Mute feature selects "on" or "off."

When this parameter is set to "on," the alert beep will sound from the front panel speaker before the repeater turns itself off.

Rpt Use: Enable/disable the Time-Out Timer while operating in the repeater mode

Double-click the left mouse button to toggle the Repeater TOT selects "yes" or "no."

The TOT time is determined via dealer programming.

TOT Beep: Enable/disable the TOT beep Transmission

Double-click the left mouse button to toggle the TOT beep selects "yes" or "no."

When this parameter is set to "yes," the alert beep will be sent out on the air before the repeater turns itself off, while operating in the "REPEATER" mode.

RPT HT: Enable/disable the Repeater Hang-on Timer

Double-click the left mouse button to toggle the Repeater Hang-on Timer selects "yes" or "no."

When this parameter is set to "yes," the repeater will remain keyed for a desired seconds after a receiving carrier is dropped.

The Hang-up time is determined via dealer programming.

RPT GT: Enable/disable the Repeater Guard

Double-click the left mouse button to toggle the Repeater Guard feature selects "yes" or "no."

When this parameter is set to "yes," the transmitter inhibit few second before the repeater is unkeyed.

The inhibit time is determined via dealer programming.

	DDec Type	Multi Tone	CWID ANI/ENI	Action Mode	Tx Freq	Encoders CTCSS	DCS	Base TOT	Base Guard	TX LOUT	TX Pwr	TOT Mute	Rpt Use	TOT Beep	RPT HT	RPT GT
1	Fixed	no	off	Duplex	166.00000	88.5	off	no	no	off	Hi	off	no	no	no	no
2	Fixed	no	off	Duplex	161.05000	100.0	off	no	no	off	Hi	off	no	no	no	no
3	Fixed	no	off	Duplex	161.10000	off	023	no	no	BTLO	Lo	off	no	no	no	no
4	Fixed	no	off	Duplex	161.15000	off	155	no	no	BTLO	Lo	off	no	no	no	no
5	Fixed	no	off	Duplex	161.20000	off	155	no	no	off	Hi	off	no	no	no	no
6	Fixed	no	off	Duplex	161.25000	88.5	off	no	no	off	Hi	off	no	no	no	no
7	Fixed	no	off	Duplex	161.30000	114.8	off	no	no	off	Hi	off	no	no	no	no
8	Fixed	no	off	Duplex	161.35000	off	351	no	no	off	Hi	off	no	no	no	no
9	Fixed	no	off	Duplex	161.40000	off	506	no	no	off	Hi	off	no	no	no	no
10	Fixed	no	off	Duplex	161.45000	off	off	no	no	BCLO	Hi	off	no	no	no	no
11	Fixed	no	off	Duplex	161.50000	100.0	off	no	no	off	Hi	off	no	no	no	no
12	Fixed	no	off	Duplex	161.55000	88.5	off	no	no	off	Hi	off	no	no	no	no
13	Fixed	no	off	Duplex	161.60000	103.5	off	no	no	off	Hi	off	no	no	no	no
14	Fixed	no	off	Duplex	161.65000	off	off	no	no	off	Hi	off	no	no	no	no
15	Fixed	no	off	Duplex	161.70000	79.7	off	no	no	off	Hi	off	no	no	no	no
16	Fixed	no	off	Duplex	161.75000	off	off	yes	yes	BCLO	Hi	on	yes	yes	yes	yes

CE27 Main Screen (Scrolled Right)

Duplexer Installation

Important Notes!

Please refer to the operating manual for your Duplexer for details regarding maximum power input, TX/RX connector locations, etc) before installing the Antenna Duplexer.

Be certain to observe and comply with the specifications for frequency separation and maximum transmitter power for the duplexer connected to the VXR-7000, particularly when using the VXD-60 xx internal duplexer. When the VXD-60 xx is used, the frequency separation must be 5 MHz (minimum) to 10 MHz (maximum).

If the VXR-7000 output power (50 Watts) is in excess of the range of the duplexer's capability, you may reduce the TX output power of the VXR-7000 before installing the Antenna Duplexer, using the following procedure:

1. Connect the VXR-7000's TX antenna port to a wattmeter and dummy load (the duplexer must not be connected at this point). Connect any Vertex Standard microphone to the **MIC** jack, and place the **BASE/REPEATER** switch in the "BASE" position. Select Channel 1 for alignment purposes.
2. Press and hold in the **ACCESSORY** switch for two seconds to enter the adjustment mode. The channel number will begin to blink.
3. Press and hold in the **PTT** key on the microphone. The display will indicate "Po" while transmitting. Observe the power output as indicated on the wattmeter.
4. Keep the holding in the **PTT** key, press the ▲ (UP: increment) or ▼ (DOWN: decrement) button (to the right of the channel display) repeatedly to adjust the TX output power to 40 Watts (or less).
5. Keep the holding in the **PTT** key, press and hold in the **ACCESSORY** button for at least two seconds to save the new setting and exit to the normal operation.
6. Release the **PTT** key.
7. Repeat steps 2. through 6. (above) for any other channels (2 through 16) if they are to be used.
8. Re-test each channel in the normal operating mode to confirm the proper power output. You may now disconnect all test equipment.
9. The duplexer may now be installed.

The above procedure should only be performed by your Authorized Vertex Standard Dealer or a qualified radio technician, in order to ensure accurate calibration. Please consult with your Authorized Vertex Standard Dealer for assistance with procurement of a suitable duplexer.

Installations

1. Remove the 14 screws affixing the top and bottom covers of repeater, and remove the covers (Figure 1).
2. Turn the repeater upside down.
3. Referring to Figure 2, remove the upper screw in either side of the front panel, and loosen the lower screw in either side of the front panel, then slide the front panel forward slightly.
4. Remove the coaxial cables connected to the TX and RX antenna jacks of the repeater.
5. Install the duplexer into the compartment on the bottom side of the repeater, using the four screws and antenna cable provided in the **CT-68** Hardware Kit (Figure 3). Some duplexers may not line up with the threaded mounting holes in the repeater's chassis. In this case, use the supplemental mounting brackets supplied with the **CT-68** Hardware Kit (Figure 4).
6. Connect the optional Antenna Cable **CT-68** between the TX antenna jack of the repeater and ANT (center) jack of the duplexer.
7. If your repeater's Tx/Rx frequency relationship is "upper shift" type ($TXf > RXf$), connect the coaxial cable from the RX Unit to the LOW PASS jack of the duplexer and connect the coaxial cable from the PA Unit to the HIGH PASS jack of the duplexer. If your repeater's Tx/Rx frequency relationship is "lower shift" type ($TXf < RXf$), connect the coaxial cable from the RX Unit to the HIGH PASS jack of the duplexer and connect the coaxial cable from the PA Unit to the LOW PASS jack of the duplexer.
Note: Route the TX coaxial cable from the PA Unit as far as possible from the RX coaxial cable from the RX Unit.
8. Duplexer installation is now complete. Replace the front panel back into place, and replace the top and bottom covers.

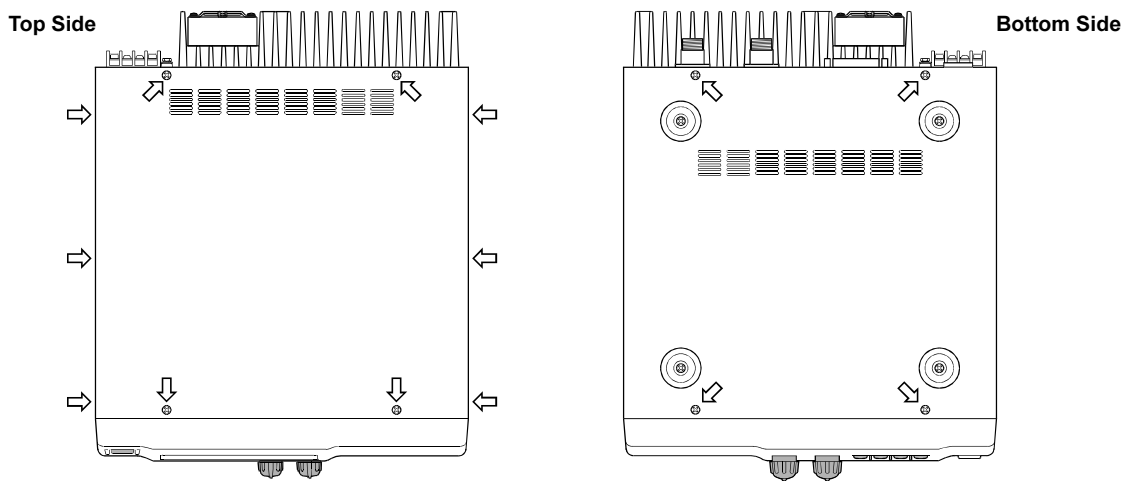

Figure 1

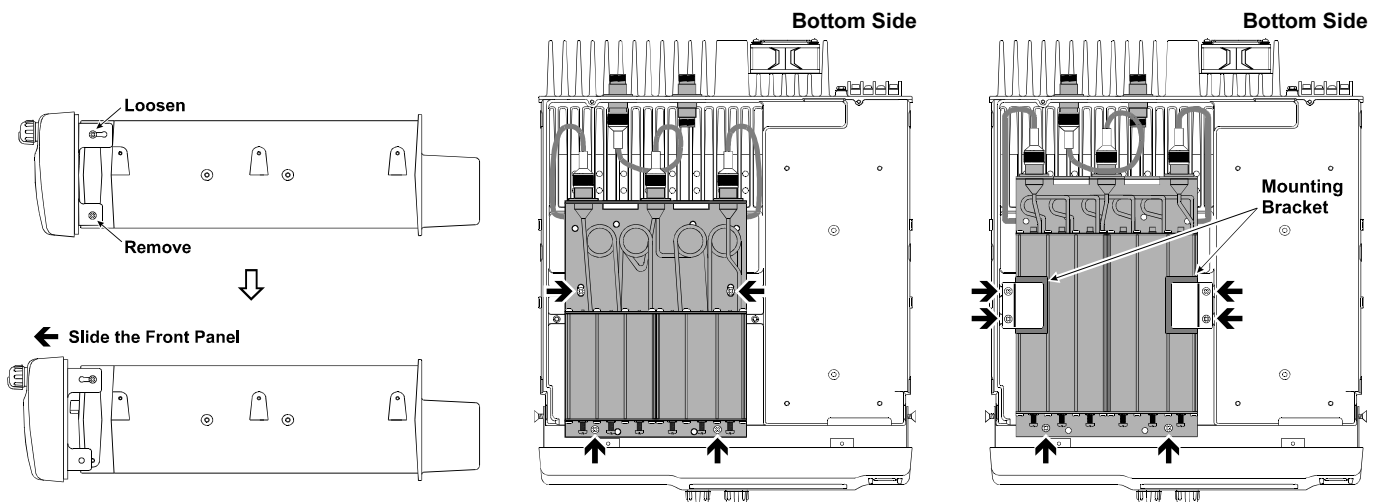

Figure 2

Figure 3

Figure 4

Specifications

General

Frequency Range:	VXR-7000v 136 ~ 150 MHz (A) or 150 ~ 174 MHz (C) VXR-7000U 400 ~ 430 MHz (A)
Emission Type:	F3E
Channel Spacing:	12.5/20/25 kHz
Number of Channels:	16 Channels
Power Requirements:	AC 200-240V 50/60 Hz 1A or DC 13.8V 7 A
Temperature Range:	-25 °C to +55 °C
Frequency Stability:	better than ±1.0 kHz
Antenna Impedance:	50 Ω (Unbalanced)
Case size (w/o knobs):	325 x 115 x 391.5 mm (W x H x D)
Weight (approx.):	10 kg

Receiver

Circuit Type:	Double-conversion Superheterodyne
Intermediate Frequency:	VXR-7000v 21.4 MHz & 455 kHz VXR-7000U 73.35 MHz & 455 kHz
Sensitivity (20 dB SINAD):	<1 dBμ emf
Conducted Spurious:	<-57 dBm @<1 GHz, <-47 dBm @>1 GHz
Squelch Sensitivity:	<-1 dBμ emf
Adjacent Channel Selectivity:	>70 dB @ SEP 25 kHz, >60 dB @ SEP 12.5 kHz
Intermodulation:	>70 dB
Spurious Rejection:	>70 dB
Hum and Noise:	>40 dB @ SEP 25 kHz, >35 dB @ SEP 12.5 kHz
Audio Output:	4 W @ 4 Ω, 10% THD

Transmitter

Modulation System:	Direct FM
Power Output:	5 to 25 W (Adjustable)
Spurious Emissions:	<-36 dBm @<1 GHz, <-30 dBm @>1 GHz
Duty Cycle:	50 %
Maximum Deviation:	±5 kHz @ SEP 25 kHz, ±2.5 kHz @ SEP 12.5 kHz
Audio Frequency Response:	+1/-3dB from the 6 dB/oct. pre-emphasis curve
Audio Distortion:	<2.5 %

Specifications are subject to change without notice or obligation.

Supplied Accessories

Item	Quantity
AC Cord (T9013285)	1
Spare 3.15AT AC Fuse (Q0000096)	1
Spare 15A DC Fuse (Q0000081 or Q0000151)	1

Optional Accessories

MH-67A&J	Standard Microphone
MD-12A&J	Desktop Microphone
VXD-60 VC	VHF Duplexer 148 - 160 MHz
CT-68	Antenna Cable w/mounting screw (for the Antenna Duplexer)
MR-3	4U Size 19" Cabinet Rack-Mount Unit
MR-4	3U Size 19" Cabinet Rack-Mount Unit
CE27	Programming Software
FIF-10A	USB Programming Interface
FIF-12	USB Programming Interface
CT-104A	PC Programming Cabel (for FIF-10A and FIF-12)

Note



Declaration of Conformity

We, Yaesu UK Ltd. declare under our sole responsibility that the following equipment complies with the essential requirements of the Directive 1999/5/EC.

Type of Equipment:	Desktop Repeater
Brand Name:	VERTEX STANDARD
Model Number:	VXR-7000V / VXR-7000U
Manufacturer:	Vertex Standard Co., Ltd.
Address of Manufacturer:	4-8-8 Nakameguro Meguro-Ku, Tokyo 153-8644, Japan

Applicable Standards:

This equipment is tested and conforms to the essential requirements of directive, as included in following standards.

Radio Standard:	EN 300 086-2 V1.1.1
EMC Standard:	EN 301 489-01 V1.8.1 EN 301 489-05 V1.3.1
Safety Standard:	EN 60065: 2002+A1: 2006

The technical documentation as required by the Conformity Assessment procedures is kept at the following address:

Company: Yaesu UK Ltd.
Address: Unit 12, Sun Valley Business Park, Winnall Close, Winchester
Hampshire, SO23 0LB, U.K.

Disposal of your Electronic and Electric Equipment

Products with the symbol (crossed-out wheeled bin) cannot be disposed as household waste. Electronic and Electric Equipment should be recycled at a facility capable of handling these items and their waste byproducts.

In EU countries, please contact your local equipment supplier representative or service center for information about the waste collection system in your country.

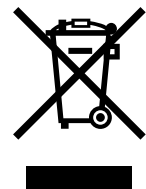



Copyright 2012
Vertex Standard LMR, Inc.
All right reserved.

No portion of this manual may be
reproduced without the permission
of Vertex Standard LMR, Inc.



Printed in Japan