

Vertex Standard

VX-820ATEX SERIES

OPERATING MANUAL

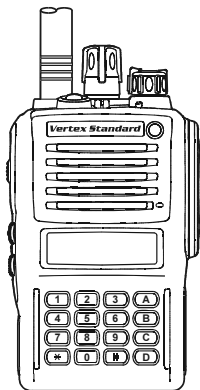

16-Key Version

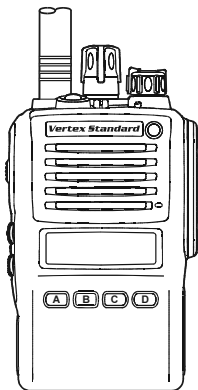

4-Key Version

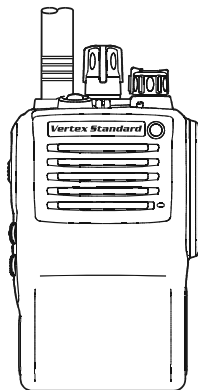

Non-LCD Version

Vertex Standard LMR, Inc.
4-8-8 Nakameguro, Meguro-Ku, Tokyo 153-8644, Japan

CONTENTS

Warning!: ATEX Intrinsically Safe Radio	1	Advanced Operation	14
Warning! RF Exposure Requirements	2	Programmable Key Functions	14
Controls & Connectors (16-Key Version)	4	Description of Operating Functions	16
Controls & Connectors (4-Key Version)	5	ARTS (Auto Range Transpond System)	24
Controls & Connectors (Non-LCD Version)	6	DTMF Paging System	24
LCD Icons & Indicators (16- & 4-Key Versions)	7	LOCK	24
Before You Begin	8	User Set Mode	25
Battery Pack Installation and Removal	8	Optional Accessories	26
Low Battery Indication	8	Disposal of your Electronic and	
Battery Charging	9	Electric Equipment	28
Operation	10		
Preliminary Steps	10		
Operation Quick Start	10		

Congratulations!

You now have at your fingertips a valuable communications tool—a **VERTEX STANDARD** two-way radio! Rugged, reliable and easy to use, your **VERTEX STANDARD** radio will keep you in constant touch with your colleagues for years to come, with negligible maintenance down-time. Please take a few minutes to read this manual carefully. The information presented here will allow you to derive maximum performance from your radio, in case questions arise later on.

We're glad you joined the **VERTEX STANDARD** team. Call on us anytime, because communications is our business. Let us help you get your message across.

Notice!: There are no owner-serviceable parts inside the radio. All service jobs must be referred to an authorized **VERTEX STANDARD** Service Representative. Consult your Authorized **VERTEX STANDARD** Dealer for installation of optional accessories.

 WARNING!: ATEX INTRINSICALLY SAFE RADIO

- The **VX-820ATEX** is approved for use in potentially explosive atmospheres according to the **ATEX EC Directive 94/9/EC**.
- The Intrinsically safe protection rating for the **VX-820ATEX** is **Ex II 2G Ex ib IIC T4 Gb** (Approved for Zone 1, Equipment Group II, Gas Group C Temperature Class T4).

The ATEX protection rating for these models is only maintained provided:

- The equipment shall not be directly installed or used in any process where its enclosure might be electrostatically charged by the rapid flow of a non-conductive media.
- Use **ONLY FNB-V100LIEX** Battery Pack. Use of other batteries will invalidate the ATEX Approval.
- Battery charging must occur **ONLY** in non - potentially explosive atmospheres.
- Use **ONLY** ATEX approved accessories in the potentially explosive atmospheres. Connect and disconnect these accessories only outside the potentially explosive atmospheres.
- Ensure that there is no external damage to the radio, antenna or battery before entering the potentially explosive atmospheres, as it might compromise the safety of the unit. eg an antenna with a damaged end or insulation must be replaced before use in any potentially explosive atmospheres.
- Servicing of ATEX radios can only be carried out Vertex Standard IS authorized personnel, who are aware of the special parts required and the procedures necessary to maintain the ATEX protection rating for these products. Consult your authorized Vertex Standard Dealer for details.
- Check the ATEX classification of each accessory listed on page 27 before using. Use of an ATEX accessory with a lower rating than that of the radio itself will reduce the radio ATEX rating to that of the lower level.
- Ambient temp range for the radio is $-10\text{ }^{\circ}\text{C}$ to $+55\text{ }^{\circ}\text{C}$.

WARNING!: RF EXPOSURE REQUIREMENTS

This Radio has been tested and complies with the 1999/519/EC RF exposure limits. In addition, it complies with the following Standards and Guidelines:

- ANSI/IEEE C95.1-1992, IEEE Standard for Safety Levels with Respect to Human Exposure to Radio Frequency Electromagnetic Fields, 3 kHz to 300 GHz.
- ANSI/IEEE C95.3-1992, IEEE Recommended Practice for the Measurement of Potentially Hazardous Electromagnetic Fields - RF and Microwave.

WARNING:

This radio generates RF electromagnetic energy during transmit mode. This radio is designed for and classified as *Occupational Use Only*, meaning it must be used only during the course of employment by individuals aware of the hazards, and the ways to minimize such hazards. This radio is not intended for use by the General Population in an uncontrolled environment.

- This radio is NOT approved for use by the general population in an uncontrolled exposure environment. This radio is restricted to occupational use, work related operations only where the radio operator must have the knowledge to control his or her RF exposure conditions.**
- When transmitting, hold the radio in a vertical position with its microphone 5 cm away from your mouth and keep the antenna at least 5 cm away from your head and body.**
- The radio must be used with a maximum operating duty cycle not exceeding 50%, in typical Push-to-Talk configurations.**

DO NOT transmit for more than 50% of total radio use time (50% duty cycle). Transmitting more than 50% of the time can cause RF exposure compliance requirements to be exceeded.

The radio is transmitting when the red LED on the top of the radio is illuminated. You can cause the radio to transmit by pressing the PTT button.

⚠ WARNING!: RF EXPOSURE REQUIREMENTS

- SAR compliance for body-worn use was only demonstrated for the specific belt-clip (CLIP-820). Other body-worn accessories or configurations may NOT comply with the RF exposure requirements and should be avoided.
- DO NOT use the radio in Body Worn configurations with the following accessories unless the associated conditions are met:
 - CLIP-820 Belt Clip: (1) During transmission there must be at least a 4cm distance between the radio and the body. (2) for monitoring purposes using the speaker or Vertex Standard authorized speaker mic accessories only; (3) for carrying purposes.
- Always use Vertex Standard authorized accessories.
- The information listed above provides the user with the information needed to make him or her aware of RF exposure, and what to do to assure themselves that the unit is operated within the RF Exposure limits of this radio.
- Electromagnetic Interference/Compatibility
 - During transmissions, this radio generates RF energy that can possibly cause interference with other devices or systems. To avoid such interference, turn off the radio in areas where signs are posted to do so.
 - Do not operate the transmitter in areas that are sensitive to electromagnetic radiation such as hospitals, health care facilities, aircraft, and blasting sites.

CONTROLS & CONNECTORS (16-KEY VERSION)

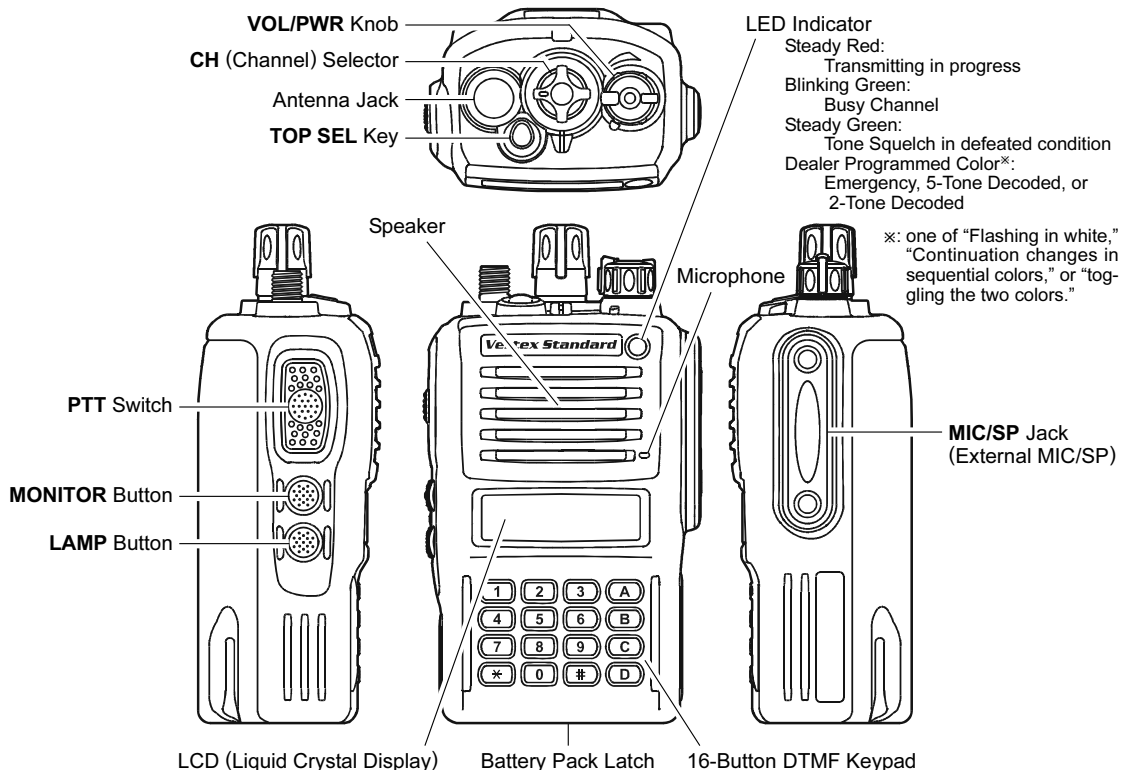

CONTROLS & CONNECTORS (4-KEY VERSION)

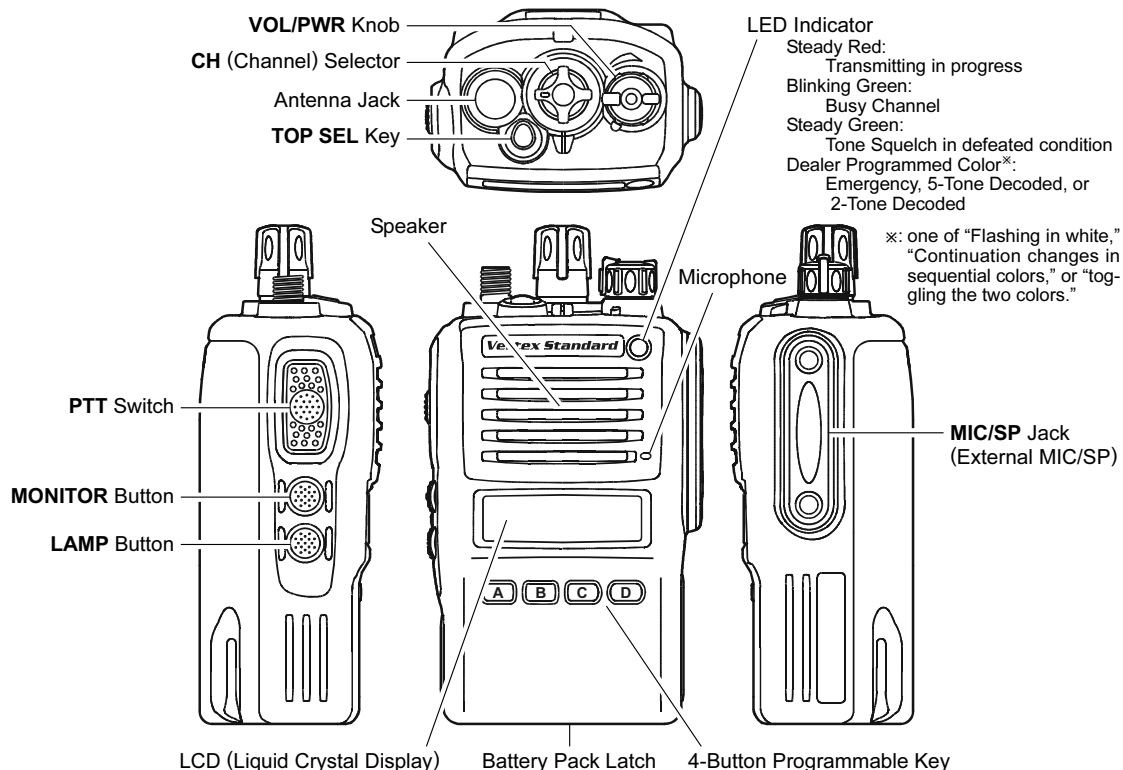

CONTROLS & CONNECTORS (NON-LCD VERSION)

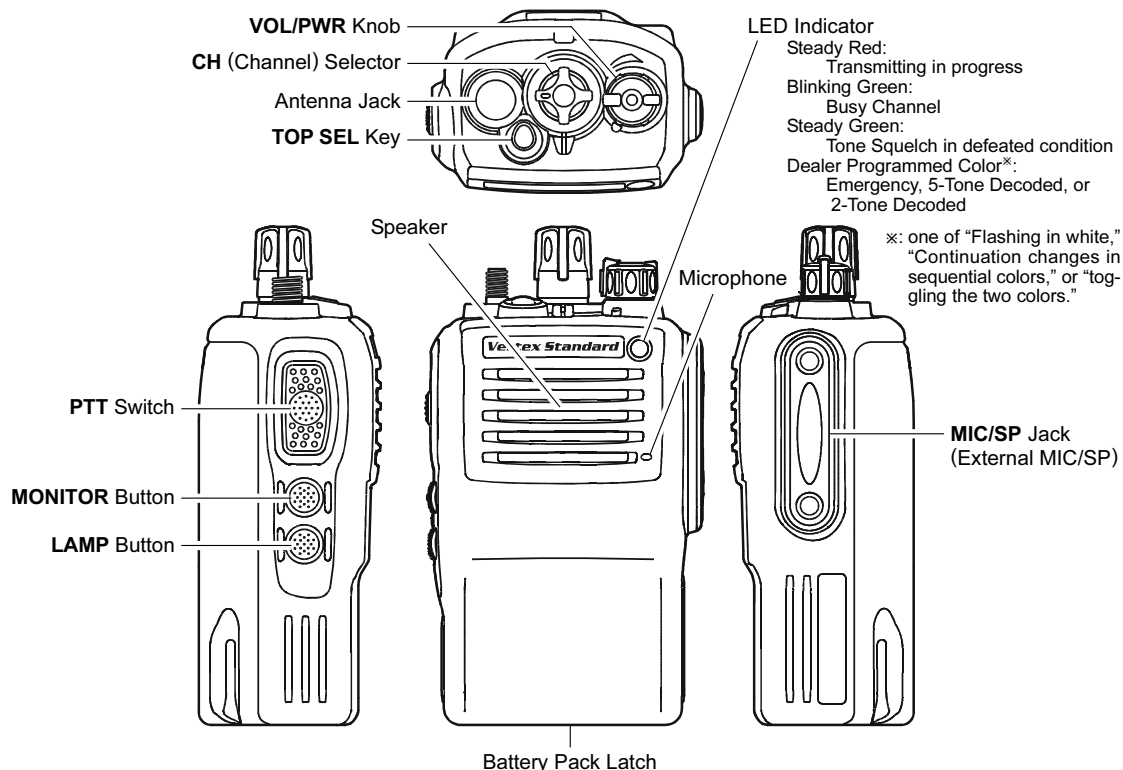

LCD ICONS & INDICATORS (16-KEY & 4-KEY VERSIONS)

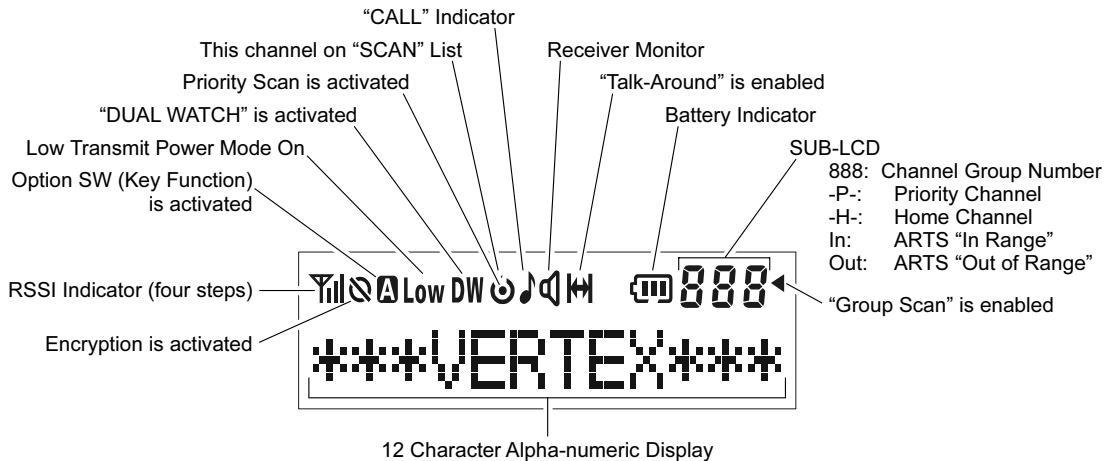

BATTERY TERMINALS

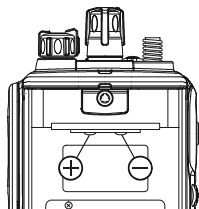

Maximum Input Voltage:	8.4 V DC
Maximum Input Current:	1 A
Maximum Input Power:	8.4 W
Maximum Internal Capacitance:	31.4 μ F

BEFORE YOU BEGIN

Battery Pack Installation and Removal

- ❑ To install the battery, hold the transceiver with your left hand, so your palm is over the speaker and your thumb is on the top of the belt clip. Carefully mate the battery's four insertion slots with their corresponding alignment tabs on the transceiver case, while tilting the Belt Clip outward. Proper alignment occurs with the battery pack offset about 1 cm from the top edge of the battery compartment.
- ❑ Guide the pack on to the tabs with a slight inward pressure, then slide the battery pack upward, until it locks in place with a "Click."

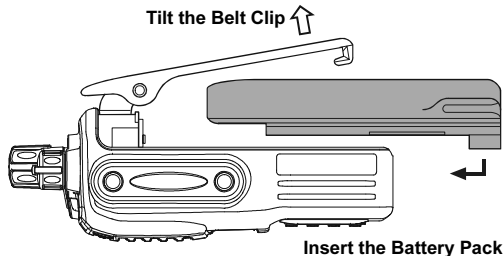

- ❑ To remove the battery, turn the radio off and remove any protective cases. Slide the Battery Pack Latch on the bottom of the radio toward the front panel while sliding the battery down about 1 cm. Then lift the battery out from the radio while unfolding the Belt Clip.



- 1) Do not remove/install the Battery Pack in a potentially explosive atmospheres.**
- 2) Do not attempt to open any of the rechargeable Lithium-Ion packs, as they could explode if accidentally short-circuited.**

Low Battery Indication

As the battery discharges during use, the voltage gradually becomes lower. When the battery voltage becomes to low, substitute a freshly charged battery and recharge the depleted pack. The LED indicator on the top of the radio will blink red when the battery voltage is low.

BEFORE YOU BEGIN

Battery Charging

- ❑ Insert the DC plug from the **PA-42** AC Adapter into the DC jack on the bottom side of the **CD-37EX** Desktop Charger, then plug the **PA-42** AC Adapter into the AC line outlet.
- ❑ Insert the battery pack into the **CD-37EX** Desktop Charger while aligning the slots of the battery pack with the guides in the nest of the **CD-37EX**; refer to the illustration at the right for details on proper positioning of the pack. If charging with the transceiver attached, turn the transceiver off, and the antenna jack should be at the left side when viewing the charger from the front.
- ❑ If the battery pack is inserted correctly, the LED indicator will glow red. A fully-discharged pack will be charged completely in approximately 3 hours.
- ❑ The LED indicator will blink red/green alternately when charging is nearing completion.
- ❑ When charging is completed, the LED indicator will change to green. Even if the charging is completed, the LED indicator will sometimes change to red for trickle charging.
- ❑ Disconnect the pack from the **CD-37EX** Desktop Charger, and unplug the **PA-42** AC Adapter from the AC line outlet.

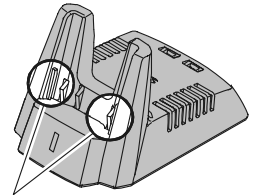
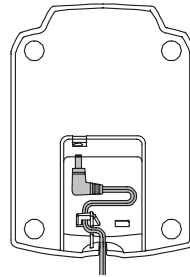

Align the slots of the battery pack with the guides in the nest of the **CD-37EX** Desktop Charger.

⚠ WARNING ⚠

- **Do not change batteries in a potentially explosive atmospheres.**
- **Do not reverse-connect the battery terminals.**
- **Do not parallel-connect the battery terminals.**
- **To reduce the risk of explosion, recharge the batteries outside of hazardous locations.**

OPERATION

Preliminary Steps

- ❑ Install a charged battery pack onto the transceiver, as described previously.
- ❑ Screw the supplied antenna onto the Antenna jack. Never attempt to operate this transceiver without an antenna connected.



Do not connect/remove the Antenna in a potentially explosive atmosphere.

- ❑ If you have a Speaker/Microphone, we recommend that it not be connected until you are familiar with the basic operation of the **VX-820ATEX**.

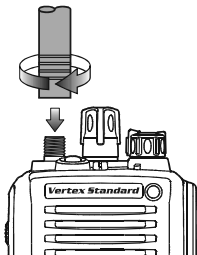

Operation Quick Start

- ❑ Turn the top panel's **VOL/PWR** knob clockwise to turn the radio on.

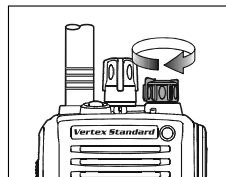

- ❑ Turn the top panel's **CH** selector knob to choose the desired operating channel. On the 16-key and 4-key versions, a channel name will appear on the LCD.

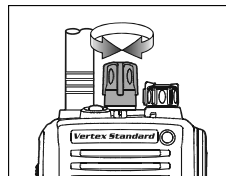

- ❑ If you want to select the operating channel from a different Memory Channel Group, press the Programmable key (assigned to the Memory Group Up or Down function) to select the Memory Channel Group you want before selecting the operating channel. A Group name will appear on the LCD whenever the Programmable key is pressed. **Note:** Some models are programmed so that the operating channels are selected by the Programmable key and the memory channel group is selected by the **CH** selector knob. For further details, contact your Vertex Standard dealer.

OPERATION

- ❑ Rotate the **VOL/PWR** knob to set the volume level. If no signal is present, press and hold in the **MONITOR** button (under the **PTT** switch) more than 2 seconds; background noise will now be heard, and you may use this to set the **VOL/PWR** knob for the desired audio level. Press and hold the **MONITOR** button more than 2 seconds (or press the **MONITOR** button *twice*) to quiet the noise and resume normal (quiet) monitoring.

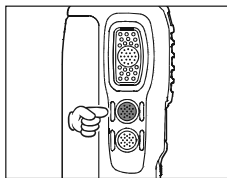
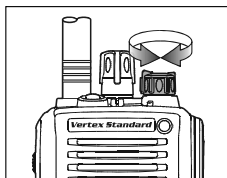

- ❑ To transmit, monitor the channel and make sure it is clear. Press and hold the **PTT** switch. Speak into the microphone area of the front panel grille (above the upper left edge of the LCD) in a normal voice level. To return to the Receive mode, release the **PTT** switch.

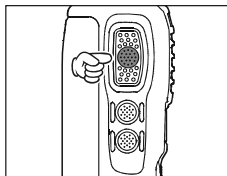

- ❑ Press the (Orange) **TOP SEL** key to activate one of the preprogrammed functions which may have been enabled at the time of programming by the dealer. See the next section for details regarding the available features.
- ❑ If a Speaker/Microphone is available, remove the plastic cap and its two mounting screws from the right side of the transceiver, then align the connector of the Speaker/Microphone on the transceiver body; secure the connector pin using the screws supplied with the Speaker/Microphone. Hold the speaker grille up next to your ear while receiving. To transmit, press the **PTT** switch on the Speaker/Microphone, just as you would on the main transceiver's body, and speak into the microphone on a normal voice level.

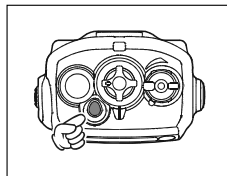

1) Do not remove/install the Speaker/Microphone in a potentially explosive atmospheres.

2) Save the original plastic cap and its mount-

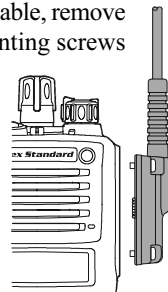

OPERATION

ing screws. They should be reinstalled when not using the Speaker/Microphone.

Note: When you press the PTT switch on the Speaker/Microphone, it disables the internal microphone, and vice versa.

- ❑ If the Busy Channel Lockout feature has been programmed on a channel, the radio will not transmit when a carrier is present. Instead, the radio will generate short beep three times and indicate “* CH Busy *” on the display (16-key and 4-key versions). Release the **PTT** switch and wait for the channel to be clear of activity.
- ❑ If CTCSS or Digital Coded Squelch (DCS) Lockout has been programmed on a channel, the radio can transmit only when there is no carrier being received or when the carrier being received includes the correct CTCSS tone or DCS code.

Automatic Time-Out Timer

If the selected channel has been programmed for automatic time-out, you must limit the length of each transmission. While transmitting, a beep will sound 10 seconds before time-out. Another beep will sound just before the deadline; the “**TX**” indicator will disappear and transmission will cease soon thereafter. To resume transmitting, you must release the **PTT** switch and wait for the “penalty timer” to expire.

NOTE

ADVANCED OPERATION

Programmable Key Functions

All versions of the **VX-820ATEX** include the **TOP SEL**, **MONITOR**, and **LAMP** keys. The 16-key and 4-key versions include the **[A]**, **[B]**, **[C]**, and **[D]** function keys. Furthermore, the 16-key version includes the **[*]** and **[#]** function keys. The Programmable key functions can be customized, via programming by your VERTEX STANDARD dealer, to meet your communications/network requirements. Some features may require the purchase and installation of optional internal accessories.

The possible Programmable key programming features are illustrated at the below and next page, and their functions are explained on page 16. For further details, contact your VERTEX STANDARD dealer.

For future reference, check the box next to each function that has been assigned to the Programmable key on your particular radio, and keep it handy.

FUNCTION	PROGRAMMABLE KEY									
	TOP SEL	MONITOR	LAMP	[A]	[B]	[C]	[D]	[*]	[#]	
None										
Monitor										
Lamp										
Scan										
Dual Watch										
Low Power										
Talk Around										
TX Save Disable										
Encryption [※]										
Follow-Me Scan										
Follow-Me Dual Watch										
Group Up										
Group Down										

※: Requires **FVP-35** or **FVP-36** Encryption Unit

ADVANCED OPERATION

FUNCTION	PROGRAMMABLE KEY									
	TOP SEL	MONITOR	LAMP	[A]	[B]	[C]	[D]	[*]	[#]	
Channel Up										
Channel Down										
Set										
Call/Reset										
Call 1										
Call 2										
Call 3										
Call 4										
Call 5										
Code Up										
Code Down										
Code Set										
Speed Dial										
Option SW 1										
Option SW 2										
Emergency										
Home										
Selectable Tone										
Direct Channel #1										
Direct Channel #2										
Direct Channel #3										
Direct Channel #4										
SQL										
AF Min Volume										
Status Set										
Status Up										
Status Down										
Status Check										
Audio PC (PIT)										
Lone Worker										
DTMF Code Set										
TA Scan										
Priority Disable										
Beep On/Off										
Whisper										

ADVANCED OPERATION

Description of Operating Functions

MONITOR

Press the assigned programmable key to cancel CTCSS- and DCS-controlled squelch; the **LED** indicator will glow green. Press and hold this button for 1.5 seconds to hear background noise (unmute the audio); the **LED** indicator will blink green.

LAMP

Press the assigned programmable key to illuminate the LCD for five seconds.

SCAN

The Scanning feature is used to monitor multiple signals programmed into the transceiver. While scanning, the transceiver will check each channel for the presence of a signal, and will stop on a channel if a signal is present.

To activate scanning:

- Press the assigned programmable key to activate scanning.
- The scanner will search the channels of each channel, looking for active ones; it will pause each time it finds a channel on which someone is speaking.
- Press the assigned programmable key again to disable scanning. Operation will revert to the programmed revert channel.

Note: Your dealer may have programmed your radio to stay on one of the following channels if you press the **PTT** switch during scanning pause:

- Current channel (“Talk Back”)
- “Last Busy” channel
- “Priority” channel
- “Home” channel
- “Scan Start” channel

ADVANCED OPERATION

DUAL WATCH

The Dual Watch feature is similar to the SCAN feature, except that only two channels are monitored:

- The current operating channel; and
- The Priority channel.

To activate Dual Watch:

- Press the assigned programmable key.
- The scanner will search the two channels; it will pause each time it finds a channel on which someone is speaking.

To stop Dual Watch:

- Press the assigned programmable key.
- Operation will revert to the “Dual Watch Start” channel.

LOW POWER

Press the assigned programmable key to set the radio’s transmitter to the “Low Power” mode, thus extending battery life. Press the key again to return to “Normal” transmit power when in difficult terrain.

When the radio’s transmitter is set to “Low Power” mode, the “**LOW**” icon will be indicated on the display.

TALK AROUND (TA)

Press the assigned programmable key to activate the Talk Around feature when you are operating on duplex channel systems (separate receive and transmit frequencies, utilizing a “repeater” station). The Talk Around feature allows you to bypass the repeater station and talk directly to a station that is nearby. This feature has no effect when you are operating on “simplex” channels, where the receive and transmit frequencies are already the same.

When the “TA” function is activated, the “

Note that your dealer may have mode provision for “Talk Around” channels by programming “repeater” and “Talk Around” frequencies on two adjacent channels. If so, the key may be used for one of the other Pre-Programmed Functions.

ADVANCED OPERATION

TX SAVE DISABLE

Press the assigned programmable key to disable the Transmit Battery Saver, if you are operating in a location where high power is almost always needed.

The Transmit Battery Saver helps extend battery life by reducing transmit power when a very strong signal from an apparently nearby station is being received. Under some circumstances, though, your hand-held radio may not be heard well at the other end of the communication path, and high power may be necessary at all times.

ENCRYPTION (OPTION)

Press the assigned programmable key to toggle the Encryption feature “On” and “Off.”

AUDIO PC (PIT)

Press the assigned programmable key to toggle the Audio Pitch Controller “On” and “Off.”

When you turn the Audio Pitch Controller ON, the receive audio is enhanced in the high-range frequencies.

FOLLOW-ME SCAN

The “Follow-Me” Scan feature checks a User-assigned Priority Channel regularly as you scan other channels. Thus, if only Channels 1, 3, and 5 (of the 8 available channels) are designated for “Scanning,” the user may nonetheless assign Channel 2 as the “User-assigned” Priority Channel via the “Follow-Me” feature.

To activate “Follow-Me” scanning, first select the channel you want to designate as the “User-Assigned Priority Channel” and press the assigned programmable key. Then rotate the **CH** Selector knob to recall to the “Scanning Start” channel which has been programmed by your dealer to activate the scanner. When the scanner stops on an “Active” channel, the User-assigned Priority Channel will automatically be checked every few seconds; if activity is found on the User-assigned Priority Channel, the radio will switch between it and the Dealer-Assigned Priority Channel, if any.

ADVANCED OPERATION

FOLLOW-ME DUAL WATCH

To set up a “Dual Watch” frequency pair using the “Follow-Me” feature, select a channel using the **CH** Selector knob. Now press the assigned programmable key; pressing the assigned programmable key locks the current channel as the User-assigned Priority Channel. Now rotate the **CH** Selector knob to select another channel (not the “Scanning Start” channel). Your radio will now switch back-and-forth between the currently-selected channel and the User-assigned Priority Channel.

During “Follow-Me” scanning (after you have pressed the key), you can set up the “Dual Watch” feature by rotating the **CH** Selector knob to another channel. The radio will then scan back and forth between the original User-assigned Priority Channel and the newly-selected channel.

The Priority Channel you have assigned (before pressing the key) will be retained in memory until you change it.

GROUP UP/DOWN

Press the assigned programmable key to select a different group of channels. Once the desired Group is reached, rotate the **CH** Selector knob to select the desired channel within the selected Group.

You may wish to have the Scanner pass through more than one Group during the scanning process (normally, scanning is performed within the current group only). To include the current Group in the scanning loop, press and hold in the assigned programmable key for one second. To remove a Group from Group Scan, press and hold in the assigned programmable key again for one second.

Multi-Group Scanning is only possible if you are using the “User Scan” list. To edit the User Scan list, press and hold the assigned programmable key for one second to delete the current Memory Group from the Scanning. Alternatively, press and hold the assigned programmable key for one second to delete the Current Memory channel from the Scanning. When you delete a Group or channel, “-SCAN Skip-” will appear on the LCD for one second after pressing the assigned programmable key. To restore a particular channel to your scanning list, press and hold in the assigned programmable key again for one second;

ADVANCED OPERATION

“-SCAN Stop-” will appear on the LCD for one second after pressing the assigned programmable key.

CHANNEL UP/DOWN

Press the assigned programmable key to select a different channel within the current group.

SET

Press the assigned programmable key to activate the “User Set” (Menu) Mode. See page 25 for details

CALL/RESET

While the DTMF Paging System

This feature, if enabled, allows the user to change the 3-digit Page Call code, used to call other similarly-equipped stations. Press the assigned programmable key, followed by the three digits representing the Page Call code of the station you wish to call. Three tones will be heard after the last key is pressed (the new code will now be transmitted).

The receiver squelch of the other station will be opened, and you can begin communication.

While the 2-Tone/5-Tone Paging System

This feature, if enabled, press the assigned programmable key to send a 2-tone/5-tone sequential tone.

CALL 1 TO CALL 5

Press the assigned programmable key to send a 2-tone/5-tone sequential tone group which is pre-defined.

CODE UP/DOWN

Press the assigned programmable key to select a 2-tone/5-tone encode code from the pre-defined encode list.

CODE SET

Press the assigned programmable key to change the encode digits for 5-tone operation. To change a specific digit, select the desired digit using the [A] key, then change the number using the [B]/[C] keys, and store the number using the [D] key.

SPEED DIAL (16-KEY VERSION ONLY)

Your Dealer may have pre-programmed Auto-Dial telephone number memories into your radio.

To dial a number, press the assigned programmable key, then press the front panel’s numeric key corresponding to the Auto-Dial memory number list provided by your Dealer or Network Administrator. The DTMF tones sent during the dialing sequence will be heard in the speaker.

ADVANCED OPERATION

OPTION SW1

During pressing and holding the assigned programmable key, activates the control port of the optional unit. Release the key to disable the control port of the optional unit.

OPTION SW2

Press the assigned programmable key to activate the control port of the optional unit. Press the key again to disable the control port of the optional unit.

EMERGENCY

The **VX-820ATEX** series include an “Emergency” feature which may be useful for alerting another party monitoring on the same frequency as your transceiver’s channel.

Press the assigned programmable key to initiate an emergency call. For further details contact your Dealer.

HOME CHANNEL

Press the assigned programmable key to recall the pre-defined Home group/channel. When you recall the Home group/channel, the “H” notation will appear on the LCD.

SELECTABLE TONE

Press the assigned programmable key to select a sub-audible tone (CTCSS/DCS) from the pre-defined tone table. You can operate using the indicated sub-audible tone in the Selectable Tone mode.

DIRECT CH#1 TO #4

Press the assigned programmable key to recall the Dealer pre-programmed channel directly.

SQL

You can manually adjust the squelch level using this function:

- Press the assigned programmable key. A tone will sound, and the current squelch level will appear on the display.
- Press the **MONITOR/LAMP** button to select the desired squelch level.
- Two seconds after releasing the **MONITOR/LAMP** button, the display will revert to the normal channel indication.

ADVANCED OPERATION

AF MIN VR

Press the assigned programmable key to reduce the audio output to the (lower) level programmed by your Dealer.

STATUS SET

Press the assigned programmable key to change the 5-Tone status code. To change the status code, select the desired digit by **[A]** key, then change the number by **[B]/[C]** key, and store the number by **[D]** key.

STATUS UP/DOWN

Press the assigned programmable key to select a 5-Tone status code from the pre-defined status list.

STATUS CHECK

Press the assigned programmable key to check the 5-Tone receive status code. When you press this key, the LCD display will indicate the “Message” corresponding to the receive status condition per the pre-defined status list.

LONE WORKER

Press the assigned programmable key to toggle the Lone Worker feature “On” and “Off.”

The Lone Worker feature is designed to emit an alarm for 30 seconds when the Lone Worker Timer (programmed by your Dealer) has expired. If the user does not reset the timer by pressing the **PTT** switch, the radio switches to the Emergency mode.

DTMF CODE SET (16-KEY VERSION ONLY)



You may send the desired telephone number manually.

To dial a number manually, press the assigned programmable key, then press the desired numbers on the front panel’s numeric key. Now, press the **PTT** switch to send the telephone number. The DTMF tones sent during the dialing sequence will be heard in the speaker.

ADVANCED OPERATION

TA SCAN

Press the assigned programmable key to toggle the TA (Talk Around) scan feature “On” and “Off.”

While TA scan is proceeding, the **VX-820ATEX** will search both the transmit and receive frequencies (the “” icon will blink). When a signal is encountered on the receive frequency, the **VX-820ATEX** will pause until the signal disappears (“” icon will appear but not blink). When a signal is encountered on the transmit frequency, the **VX-820ATEX** will check for activity on the receive frequency every few seconds (interval programmed by your Dealer).

PRIORITY DISABLE

Press the assigned Programmable key to disable the Priority feature temporarily. Again press the assigned Programmable key to resume the Priority feature.

BEEP ON/OFF

Press the assigned Programmable key to disable the radio beeps temporarily. Again press the assigned Programmable key to enable the radio beeps.

WHISPER

Press the assigned Programmable key to increase the microphone gain; thus you can speak in a low voice (whisper) temporarily. Again press the assigned Programmable key to resume normal microphone gain.

ARTS (AUTO RANGE TRANSPOND SYSTEM)

This system is designed to inform you when you and another ARTS-equipped station are within communication range.

During ARTS operation, when the radio receives the correct ARTS signal, a short beep will sound and the “**In**” (meaning “In Service”) notation will be displayed on the sub-LCD. If you move out of range for more than two minutes, your radio senses that no signal has been received; three short beeps will sound, and “**Out**” (“Out of Service”) will be displayed on the sub-LCD. If you subsequently move back into range, as soon as the other station transmits, a short beep will sound and “**In**” will be displayed again on the sub-LCD.

DTMF PAGING SYSTEM

This system allows paging and selective calling, using DTMF tone sequences.

When your radio is paged by a station bearing a tone sequence which matches yours, your radio’s squelch will open and the alert will sound. The three-digit code of the station which paged you will be displayed on your radio’s LCD.

LOCK

In order to prevent accidental channel change or inadvertent transmission, various aspects of the transceiver’s knob, programmable keys, and **PTT** switch may be locked.

The precise lockout configuration is programmed by your Dealer.

To locked out the key locking, turn the radio off. Now, press and hold the **PTT** and **LAMP** key while turning the radio on again.

To cancel locking, repeat this process.

USER SET MODE

The **VX-820ATEX** Series includes a “User Set (Menu)” Mode which allows the user to define or configure various settings, such as Beep On/Off, Squelch, LCD contrast, etc. To activate the “User Set (Menu)” Mode:

- Press the assigned programmable key for the “SET” function to enter the “User Set Mode.”
- Select the User Set Mode Item you want change using the **CH** selector knob.
- Press the **MONITOR/LAMP** button to select the status of the selected item.
- Press **PTT** switch to exit to normal operation.

DISPLAY	DESCRIPTION
1 SQL	Select the Squelch Threshold Level
2 SCN List	Select the Scan List “User” or “Dealer”
3 BEEP	Set the Beep On/Off
4 BELL	Set the Bell On/Off (Bell engaged by sub-audible CTCSS/DCS)
5 Lighting	Set the BUSY/TX LED On/Off
6 Lock	Set the Lock function to be Locked (Key/PTT/Key+PTT)
7 Group	Set the Operation Group
8 SCAN	Set the Scan status (same function as Scan key)
9 DW	Set the Dual Watch status (same function as DW key)
10 TA	Set the Talk Around status (same function as TA key)
11 AF MinVR	Set the Minimum Volume level
12 Beep VR	Set the Beep volume level
13 Contrast	Set the LCD contrast
14 Pitch	Not available at this time

OPTIONAL ACCESSORIES

FNB-V100LIEX	7.4V, 1500 mAh Lithium-Ion Battery
CD-37EX	Desktop Charger
PA-42	AC Adapter
VAC-6921EX	6-Unit Multi Charger
FVP-35	Encryption Unit (Rolling Code Voice Scrambler)
FVP-36	Encryption Unit (Voice Inversion Scrambler)
VME-100	ANI Encoder Unit
VMDE-200	ANI Encoder/Decoder Unit
MH-50D7A	Speaker/Microphone
MH-66A7A	Submerible Speaker/Microphone
MH-66B7A	Submerible Speaker/Microphone
CLIP-820	Belt Clip
ATV-8A	VHF Antenna (134-151 MHz)
ATV-8B	VHF Antenna (150-163 MHz)
ATV-8C	VHF Antenna (161-174 MHz)
ATV-6XL	VHF Antenna (134-174 MHz, Untuned)
ATU-6A	UHF Antenna (400-430 MHz)
ATU-6B	UHF Antenna (420-450 MHz)
ATU-6C	UHF Antenna (440-470 MHz)
CE59	Programming Software
FIF-10A	USB Programming Interface
CT-29	RS-232C Programming Interface Cable
CT-108	PC Programming Cable (for FIF-10)
CT-115	PC Programming Cable (for CT-29)
CT-116	Radio to Radio Cloning Cable

*Availability of accessories may vary;
some accessories are supplied standard
per local requirements, others may be
unavailable in some regions.*

*Check with your VERTEX STANDARD
Dealer for changes to this list.*

OPTIONAL ACCESSORIES

The following accessories are not ATEX Approved and must not be used in a potentially explosive atmospheres.

CD-37EX	Desktop Charger
PA-42	AC Adapter
VAC-6921EX	6-Unit Multi Charger
CE59	Programming Software
FIF-10A	USB Programming Interface
CT-29	RS-232C Programming Interface Cable
CT-108	PC Programming Cable (for FIF-10)
CT-115	PC Programming Cable (for CT-29)
CT-116	Radio to Radio Cloning Cable

DISPOSAL OF YOUR ELECTRONIC AND ELECTRIC EQUIPMENT

Products with the symbol (crossed-out wheeled bin) cannot be disposed as household waste.

Electronic and Electric Equipment should be recycled at a facility capable of handling these items and their waste byproducts.

In EU countries, please contact your local equipment supplier representative or service center for information about the waste collection system in your country.



ATTENTION IN CASE OF USE

This transceiver works on frequencies which are not generally permitted.

For frequency allocation, apply for a licence at your local spectrum management authority.

For actual usage contact your dealer or sales shop in order to get your transceiver adjusted to the allocated frequency range.

List of the practicable area					
AUT	BEL	BGR	CYP	CZE	DEU
DNK	ESP	EST	FIN	FRA	GBR
GRC	HUN	IRL	ITA	LTU	LUX
LVA	MLT	NLD	POL	PRT	ROU
SVK	SVN	SWE	CHE	ISL	LIE
NOR					



Declaration of Conformity

We, YAESU UK LTD. declare under our sole responsibility that the following equipment complies with the essential requirements of the Directive 1999/5/EC.

Type of Equipment:	FM Transceiver
Brand Name:	VERTEX STANDARD
Model Number:	VX-820ATEX Series
Manufacturer:	Vertex Standard Co., Ltd.
Address of Manufacturer:	4-8-8 Nakameguro Meguro-Ku, Tokyo 153-8644, Japan

Applicable Standards:

This equipment is tested and conforms to the essential requirements of directive, as included in following standards.

Radio Standard:	EN 300 086-2
	EN 300 113-2
EMC Standard:	EN 301 489-1
	EN 301 489-5
Safety Standard:	EN 60065
ATEX Approval:	EC Directive 94/9/EC
CE 05180	EN 60079-0: 2006
	EN 60079-11:2007
	Certification SIRA 07ATEX2264X

The technical documentation as required by the Conformity Assessment procedures is kept at the following address:

Company: YAESU UK LTD.
Address: Unit 12, Sun Valley Business Park, Winnall Close
Winchester, Hampshire, SO23 0LB, U.K.



Copyright 2012
Vertex Standard LMR, Inc.
All rights reserved.

No portion of this manual
may be reproduced
without the permission of
Vertex Standard LMR, Inc.

Printed in Japan

