

PROFESSIONAL DIGITAL TWO-WAY RADIO

MOTOTRBO™ XPR™ 6580 IS DISPLAY PORTABLE USER GUIDE



Declaration of Conformity

This declaration is applicable to your radio **only** if your radio is labeled with the FCC logo shown below.

DECLARATION OF CONFORMITY

Per FCC CFR 47 Part 2 Section 2.1077(a)



Responsible Party

Name: Motorola Solutions, Inc.

Address: 1303 East Algonquin Road, Schaumburg, IL 60196-1078, U.S.A.

Phone Number: 1-800-927-2744

Hereby declares that the product:

Model Name: **XPR 6580 IS**

conforms to the following regulations:

FCC Part 15, subpart B, section 15.107(a), 15.107(d) and section 15.109(a)

Class B Digital Device

As a personal computer peripheral, this device complies with Part 15 of the FCC Rules. This device complies with Industry Canada licence-exempt RSS standard(s). Operation is subject to the following two conditions:

1. This device may not cause harmful interference, and
2. This device must accept any interference received, including interference that may cause undesired operation.

Note: This equipment has been tested and found to comply with the limits for a Class B digital device, pursuant to part 15 of the FCC Rules. These limits are designed to provide reasonable protection against harmful interference in a residential installation. This equipment generates, uses and can radiate radio frequency energy and, if not installed and used in accordance with the instructions, may cause harmful interference to radio communications. However, there is no guarantee that interference will not occur in a particular installation.

If this equipment does cause harmful interference to radio or television reception, which can be determined by turning the equipment off and on, the user is encouraged to try to correct the interference by one or more of the following measures:

- Reorient or relocate the receiving antenna.
- Increase the separation between the equipment and receiver.
- Connect the equipment into an outlet on a circuit different from that to which the receiver is connected.
- Consult the dealer or an experienced radio/TV technician for help.

Contents

This User Guide contains all the information you need to use the MOTOTRBO XPR IS Series Digital Portable Radios.

Declaration of Conformity	i
Important Safety Information	vii
Product Safety and RF Exposure Compliance ..	vii
Software Version	vii
Computer Software Copyrights	viii
Getting Started	1
How to Use This Guide	1
What Your Dealer/System Administrator Can Tell You	1
Preparing Your Radio for Use	2
Charging the Battery	2
Attaching the Battery	2
Attaching the Antenna	3
Attaching the Belt Clip	4
Attaching the Universal Connector Cover (Dust Cover)	4
Powering Up the Radio	5
Adjusting the Volume	6

Identifying Radio Controls	6
Radio Controls	7
Programmable Buttons	8
Assignable Radio Functions	8
Assignable Settings or Utility Functions	9
Accessing the Programmed Functions	9
Using the Keypad	10
Push-To-Talk (PTT) Button	11
Switching Between Conventional Analog and Digital Mode	12
Capacity Plus	12
Identifying Status Indicators	13
Display Icons	13
Call Icons	14
Sent Item Icons	15
LED Indicator	15
Audio Tones	16
Indicator Tones	16
Making and Receiving Calls	17
Selecting a Site	17
Selecting a Zone	17
Selecting a Radio Channel, Subscriber ID, or Group ID	18
Receiving and Responding to a Radio Call	19

Receiving and Responding to a Group Call	19	Viewing an Entry in the Scan List by Alias Search	33
Receiving and Responding to a Private Call . . .	20	Editing the Scan List	34
Receiving an All Call	21	Adding a New Entry to the Scan List	34
Making a Radio Call	22	Deleting an Entry from the Scan List	34
Making a Call with the Channel Selector Knob . .	22	Setting and Editing Priority for an Entry in the Scan List	35
Making a Group Call	22	Scan	36
Making a Private Call	23	Starting and Stopping Scan	37
Making an All Call	24	Responding to a Transmission During a Scan . .	37
Making a Group or Private Call with the One Touch Access Button	25	Deleting a Nuisance Channel	38
Making a Group, Private or All Call with the Programmable Number Key	26	Restoring a Nuisance Channel	38
Stopping a Radio Call	27	Contacts Settings	39
Talkaround	27	Making a Group Call from Contacts	39
Monitoring Features	28	Making a Private Call from Contacts	40
Monitoring a Channel	28	Making a Call by Alias Search	41
Permanent Monitor	28	Assigning an Entry to a Programmable Number Key	43
Advanced Features	29	Removing the Association between Entry and Programmable Number Key	44
Radio Check	29	Call Indicator Settings	44
Sending a Radio Check	29	Activating and Deactivating Call Ringers for Private Calls	44
Remote Monitor	31	Activating and Deactivating Call Ringers for Text Message	45
Initiating Remote Monitor	31	Activating and Deactivating Call Ringers for	
Stopping Remote Monitor	32		
Scan Lists	33		
Viewing an Entry in the Scan List	33		

Telemetry Status with Text	45	Sending a Quick Text Message with the One Touch Access Button	58
Assigning Ring Styles	46	Accessing the Drafts Folder	58
Escalating Alarm Tone Volume	46	Viewing a Saved Text Message	58
Call Log Features	47	Editing and Sending a Saved Text Message	59
Viewing Recent Calls	47	Deleting a Saved Text Message from Drafts	59
Missed Call Screen	47	Managing Fail-to-Send Text Messages	60
Storing an Alias or ID from the Missed Call List	48	Resending a Text Message	60
Deleting a Call from a Call List	48	Forwarding a Text Message	60
Call Alert Operation	49	Editing a Text Message	61
Receiving and Responding to a Call Alert	49	Managing Sent Text Messages	61
Making a Call Alert from the Contacts List	49	Viewing a Sent Text Message	62
Making a Call Alert with the One Touch Access Button	50	Sending a Sent Text Message	62
Emergency Operation	50	Deleting All Sent Text Messages from Sent Items	64
Receiving an Emergency Alarm	51	Receiving a Text Message	64
Responding to an Emergency Alarm	52	Reading a Text Message	64
Sending an Emergency Alarm	53	Managing Received Text Messages	65
Sending an Emergency Alarm with Call	53	Viewing a Text Message from the Inbox	65
Sending an Emergency Alarm with Voice to Follow	54	Viewing a Telemetry Status Text Message from the Inbox	65
Reinitiating an Emergency Mode	55	Replying to a Text Message from the Inbox	66
Exiting Emergency Mode	55	Deleting a Text Message from the Inbox	67
Text Message Features	56	Deleting All Text Messages from the Inbox	67
Writing and Sending a Text Message	56	Privacy	68
Sending a Quick Text Message	57	Dual Tone Multi Frequency (DTMF)	69

IP Site Connect	69
Starting an Automatic Site Search	70
Stopping an Automatic Site Search	71
Starting a Manual Site Search	71
Security	72
Radio Disable	72
Radio Enable	73
Lone Worker	74
Password Lock Features	74
Accessing the Radio from Password	74
Unlocking the Radio from Locked State	75
Turning the Password Lock On or Off	75
Changing the Password	76
Utilities	77
Locking and Unlocking the Keypad	77
Turning Keypad Tones On or Off	77
Setting the Squelch Level	78
Turning the Option Board Feature(s) On or Off	78
Turning the Voice Operating Transmission (VOX) Feature On or Off	78
Controlling the Display Backlight	79
Turning the Radio Tones/Alerts On or Off	80
Setting the Tone Alert Volume Offset Level	80
Turning the Talk Permit Tone On or Off	81
Turning the LED Indicator On or Off	81

Turning the Introduction Screen On or Off	81
Accessing General Radio Information	82
Accessing the Battery Information	82
Checking the Radio Alias and ID	83
Checking the Firmware Version	83
Checking the Codeplug Version	83
Accessories	84
Antennas	84
Batteries	84
Carry Devices	85
Chargers	85
Earbuds and Earpieces	85
Headsets and Headset Accessories	85
Remote Speaker Microphones	85
Miscellaneous Accessories	85
Batteries and Chargers Warranty	86
Limited Warranty	87

Important Safety Information

Product Safety and RF Exposure Compliance



Caution

Before using this product, read the operating instructions for safe usage contained in the Product Safety and RF Exposure booklet enclosed with your radio.

ATTENTION!

This radio is restricted to occupational use only to satisfy FCC RF energy exposure requirements.

Before using this product, read the RF energy awareness information and operating instructions in the Product Safety and RF Exposure booklet enclosed with your radio (Motorola Publication part number 6881095C98) to ensure compliance with RF energy exposure limits.

For a list of Motorola-approved antennas, batteries, and other accessories, visit the following website:

<http://www.motorolasolutions.com/governmentandenterprise>

Any modification to this device, not expressly authorized by Motorola, may void the user's authority to operate this device.

Under Industry Canada regulations, this radio transmitter may only operate using an antenna of a type and maximum (or lesser) gain approved for the transmitter by Industry Canada. To reduce potential radio interference to other users, the antenna type and its gain should be so chosen that the equivalent isotropically radiated power (e.i.r.p.) is not more than that necessary for successful communication.

Software Version

All the features described in the following sections are supported by the radio's software version **R01.07.00** or later.

See **Checking the Firmware Version** on page 83 to determine your radio's software version.

Check with your dealer or system administrator for more details of all the features supported.

Computer Software Copyrights

The Motorola products described in this manual may include copyrighted Motorola computer programs stored in semiconductor memories or other media. Laws in the United States and other countries preserve for Motorola certain exclusive rights for copyrighted computer programs including, but not limited to, the exclusive right to copy or reproduce in any form the copyrighted computer program. Accordingly, any copyrighted Motorola computer programs contained in the Motorola products described in this manual may not be copied, reproduced, modified, reverse-engineered, or distributed in any manner without the express written permission of Motorola. Furthermore, the purchase of Motorola products shall not be deemed to grant either directly or by implication, estoppel, or otherwise, any license under the copyrights, patents or patent applications of Motorola, except for the normal non-exclusive license to use that arises by operation of law in the sale of a product.

The AMBE+2™ voice coding Technology embodied in this product is protected by intellectual property rights including patent rights, copyrights and trade secrets of Digital Voice Systems, Inc.

This voice coding Technology is licensed solely for use within this Communications Equipment. The user of this Technology is explicitly prohibited from attempting to decompile, reverse engineer, or disassemble the Object Code, or in any other way convert the Object Code into a human-readable form.

U.S. Pat. Nos. #5,870,405, #5,826,222, #5,754,974, #5,701,390, #5,715,365, #5,649,050, #5,630,011, #5,581,656, #5,517,511, #5,491,772, #5,247,579, #5,226,084 and #5,195,166.

Getting Started

Take a moment to review the following:

How to Use This Guide	page 1
What Your Dealer/System Administrator Can Tell You.	page 1

■ How to Use This Guide

This User Guide covers the basic operation of the MOTOTRBO Portables.

However, your dealer or system administrator may have customized your radio for your specific needs. Check with your dealer or system administrator for more information.

Throughout this publication, the icons below are used to indicate features supported in either the conventional Analog mode or conventional Digital mode:



Indicates a conventional **Analog Mode-Only** feature.



Indicates a conventional **Digital Mode-Only** feature.

For features that are available in **both** conventional Analog and Digital modes, **no** icon is shown.

Selected features are **also** available on the single-site trunking mode, Capacity Plus. See **Capacity Plus** on page 12 for more information.

■ What Your Dealer/System Administrator Can Tell You

You can consult your dealer or system administrator about the following:

- Is your radio programmed with any preset conventional channels?
- Which buttons have been programmed to access other features?
- What optional accessories may suit your needs?

Preparing Your Radio for Use

Assemble your radio by following these steps:

- Charging the Battery page 2
- Attaching the Battery page 3
- Attaching the Antenna page 3
- Attaching the Belt Clip page 4
- Attaching the Universal Connector
 - Cover (Dust Cover) page 4
- Powering Up the Radio page 5
- Adjusting the Volume page 6

Charging the Battery

Your radio is powered by Lithium-Ion (Li-Ion) battery. To avoid damage and comply with warranty terms, charge the battery using a Motorola charger *exactly* as described in the charger user guide.

If battery is attached to your radio, ensure that your radio is turned off before charging.

Charge a new battery 14 to 16 hours before initial use for best performance.



Caution

Charge battery only in non-hazardous areas. After battery is charged, allow your radio to rest for at least, 3 minutes. See *Batteries* on page 84 for the available batteries.

IMPORTANT: **ALWAYS** charge your IMPRES battery with an IMPRES charger for optimized battery life and valuable battery data. IMPRES batteries charged exclusively with IMPRES chargers receive a 6-month capacity warranty extension over the standard Motorola Premium battery warranty duration.

■ Attaching the Battery

Align the battery with the rails on the back of the radio. Press the battery firmly, and slide upward until the latch snaps into place. Slide battery latch into lock position.

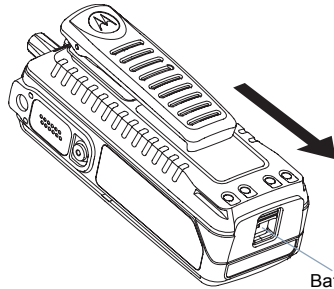
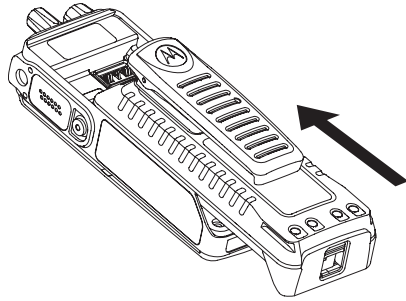

Battery Latch

To remove the battery, turn the radio off. Move the battery latch into unlock position and hold, and slide the battery down and off the rails.



Caution

Do not change battery in gas and dust environments. Replace battery only in non-hazardous areas. See *Batteries* on page 84 for the available batteries.

■ Attaching the Antenna

With the radio turned off, set the antenna in its receptacle and turn clockwise.

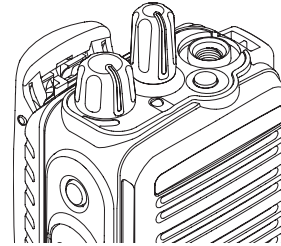

To remove the antenna, turn the antenna counterclockwise. Make sure you turn off the radio and remove the universal connector cover (dust cover) first.



Caution

If antenna needs to be replaced, ensure that only MOTOTRBO antennas are used. Neglecting this will damage your radio. See **Antennas** on page 84 for a list of available antennas.

■ Attaching the Belt Clip

Align the grooves on the clip with those on the battery and press downward until you hear a click.

To remove the clip, press the belt clip tab away from the battery. Then slide the clip upward and away from the radio.

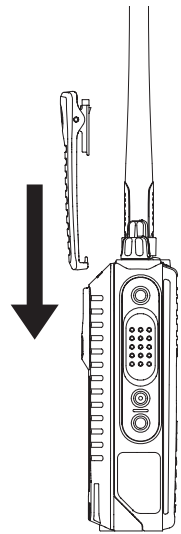

■ Attaching the Universal Connector Cover (Dust Cover)

The universal connector is located on the antenna side of the radio. It is used to connect MOTOTRBO accessories to the radio.

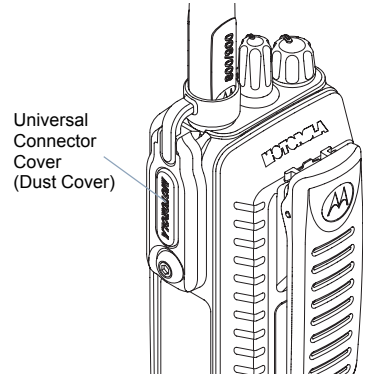

Place the universal connector cover loop over the attached antenna. Slide it all the way down to the base of the antenna.

Insert the hooked end of the cover into the slots above the universal connector. Press downward on the cover to seat the lower tab properly into the RF connector.

Turn the thumbscrew clockwise to secure the connector cover to the radio.

To remove the universal connector cover, press down on the cover and turn the thumbscrew counterclockwise. Lift the cover up, slide the connector cover loop upwards, and remove it from the attached antenna.

Replace the dust cover when the universal connector is not in use.

■ Powering Up the Radio

Rotate the **On/Off/Volume Control Knob** clockwise until you hear a click. You see **Motorola** and **MOTOTRBO (TM)** on the radio's display momentarily, followed by **Motorola** once more.

The LED blinks green and the Home screen lights up if the backlight setting is set to turn on automatically.

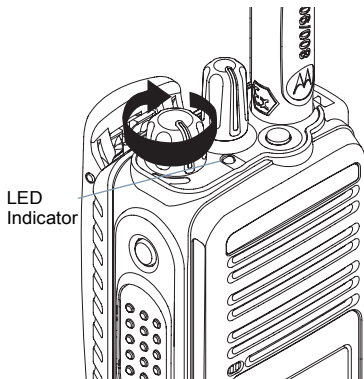

NOTE: The Home screen does not light up during a power up if the LED indicator is disabled (see **Turning the LED Indicator On or Off** on page 81).

A brief tone sounds, indicating that the power up test is successful.

NOTE: There is no power up tone if the radio tones/alerts function is disabled (see **Turning the Radio Tones/Alerts On or Off** on page 80).

If your radio does not power up, check your battery. Make sure that it is charged and properly attached. If your radio still does not power up, contact your dealer.

To turn off the radio, rotate this knob counterclockwise until you hear a click. You see a brief *Powering Down* on the radio's display.

■ Adjusting the Volume

To increase the volume, turn the **On/Off/Volume Control Knob** clockwise.

To decrease the volume, turn this knob counterclockwise.

NOTE: Your radio can be programmed to have a minimum volume offset where the volume level cannot be turned down fully. Check with your dealer or system administrator for more information.

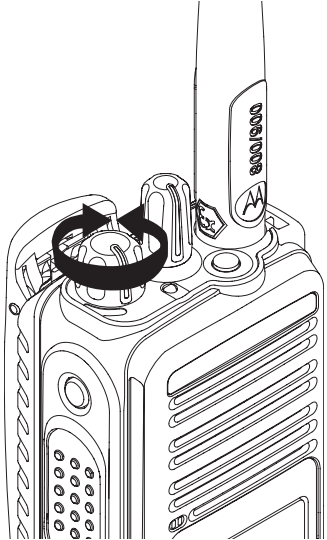

Identifying Radio Controls

Take a moment to review the following:

- Radio Controls page 7
- Programmable Buttons page 8
- Accessing the Programmed Functions page 9
- Using the Keypad page 10
- Push-To-Talk (PTT) Button page 11
- Switching Between Conventional Analog and Digital Mode page 12
- Capacity Plus page 12

Radio Controls

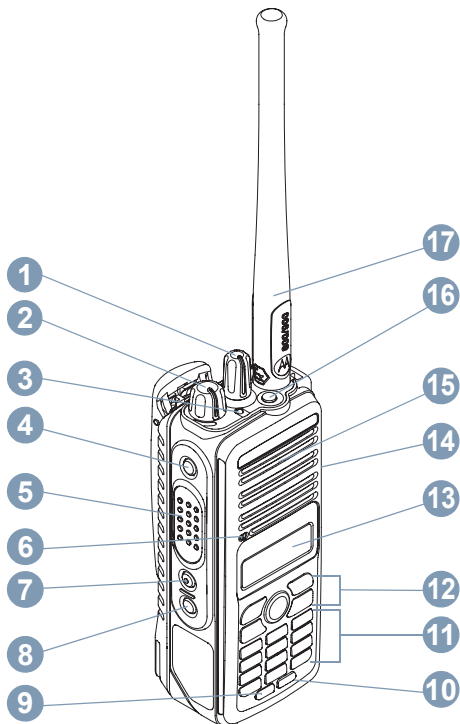

- 1 Channel Selector Knob
- 2 On/Off/Volume Control Knob
- 3 LED Indicator
- 4 Side Button 1*
- 5 Push-to-Talk (PTT) Button
- 6 Microphone
- 7 Side Button 2*
- 8 Side Button 3*
- 9 Front Button P1*
- 10 Front Button P2*
- 11 Keypad
- 12 Menu Navigation Keys
- 13 Display
- 14 Universal Connector for Accessories
- 15 Speaker
- 16 Emergency Button*
- 17 Antenna

* These buttons are programmable.

■ Programmable Buttons

Your dealer can program the programmable buttons as shortcuts to **radio functions** or **preset channels/groups** depending on the duration of a button press:

- Short press – Pressing and releasing rapidly (0.05 seconds).
- Long press – Pressing and holding for the programmed duration (between 1.00 second and 3.75 seconds).
- Hold down – Keeping the button pressed.

NOTE: The programmed duration of a button press is applicable for all assignable radio/utility functions or settings. See **Emergency Operation** on page 50 for more information on the programmed duration of the **Emergency** button.

📄 Assignable Radio Functions

Contacts – Provides direct access to the Contacts list.

Emergency – Depending on the programming, initiates or cancels an emergency alarm or call.

Manual Dial  – Initiates a call by keying in any subscriber ID.

Manual Site Roam*  – Starts the manual site search.

Monitor – Monitors a selected channel for activity.

Nuisance Channel Delete* – Temporarily removes an unwanted channel, except for the Selected Channel, from the scan list. The Selected Channel refers to the user's selected zone/channel combination from which scan is initiated.

One Touch Access  – Directly initiates a predefined Private or Group Call, a Call Alert or a Quick Text message.

Option Board Feature – Toggles option board feature(s) on or off for option board-enabled channels.

Permanent Monitor* – Monitors a selected channel for all radio traffic until function is disabled.

Privacy  – Toggles privacy on or off.

Radio Alias and ID – Provides radio alias and ID.

Radio Check  – Determines if a radio is active in a system.

Radio Enable  – Allows a target radio to be remotely enabled.

Radio Disable  – Allows a target radio to be remotely disabled.

Remote Monitor  – Turns on the microphone of a target radio without it giving any indicators.

Repeater/Talkaround* – Toggles between using a repeater and communicating directly with another radio.

* Not applicable in Capacity Plus

Scan* – Toggles scan on or off.

Site Lock On/Off*  – Toggles the automatic site roam on or off.

Telemetry Control  – Controls the Output Pin on a local or remote radio.

Text Message  – Selects the text message menu.

Transmit Interrupt Remote Dekey  – Stops the transmission of a remote monitored radio without giving any indicators, or an ongoing interruptible call to free the channel.

Voice Operating Transmission (VOX) – Toggles VOX on or off.

Zone – Allows selection from a list of zones.

Assignable Settings or Utility Functions

All Tones/Alerts – Toggles all tones and alerts on or off.

Backlight – Toggles display backlight on or off.

Keypad Lock – Toggles keypad between locked and unlocked.

Power Level – Toggles transmit power level between high and low.

Squelch  – Toggles squelch level between tight and normal.

** Not applicable in Capacity Plus*

■ Accessing the Programmed Functions







You can access various radio functions through one of the following ways:

- A short or long press of the relevant programmable buttons.



OR

- Use the Menu Navigation Buttons as follows:

- 1 To access the menu, press the  button. Press the appropriate **Menu Scroll** button ( or ) to access the menu functions.
- 2 To select a function or enter a sub-menu, press the  button.
- 3 To go back one menu level, or to return to the previous screen, press the  button. Long press the  button to return to the Home screen.

NOTE: Your radio automatically exits the menu after a period of inactivity and returns to your Home screen.

■ Using the Keypad

You can use the 3 x 4 alphanumeric keypad to access your radio's features. You can use the keypad to enter subscriber aliases or IDs, and text messages. Many characters require that you press a key multiple times. The table below shows the number of times a key needs to be pressed to generate the required character.

Key	Number of Times Key is Pressed												
	1	2	3	4	5	6	7	8	9	10	11	12	13
1 .?	1	.	,	?	!	@	&	'	%	-	:	*	#
2 abc	A	B	C	2									
3 def	D	E	F	3									
4 ghi	G	H	I	4									
5 jkl	J	K	L	5									
6 mno	M	N	O	6									
7 pqrs	P	Q	R	S	7								
8 tuv	T	U	V	8									
9 wxyz	W	X	Y	Z	9								
0 CAPS	0	NOTE: Press to enter "0" and long press to activate the CAPS lock. Another long press to turn off the CAPS lock.											
* DEL	* or del	NOTE: Press during text entry to delete the character. Press during numeric entry to enter a "*" .											
# —	# or space	NOTE: Press during text entry to insert a space. Press during numeric entry to enter a "#".											

■ Push-To-Talk (PTT) Button

The **PTT** button on the side of the radio serves two basic purposes:

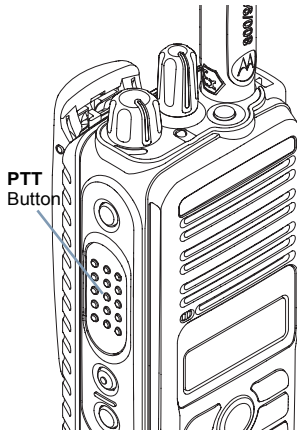





- While a call is in progress, the **PTT** button allows the radio to transmit to other radios in the call.

Press and hold down **PTT** button to talk. Release the **PTT** button to listen.

The microphone is activated when the **PTT** button is pressed.

- While a call is not in progress, the **PTT** button is used to make a new call (see **Making a Radio Call** on page 22).

If the Talk Permit Tone (see **Turning the Talk Permit Tone On or Off** on page 81) or the **PTT** Sidetone  is enabled, wait until the short alert tone ends before talking.

-  During a call, if the Channel Free Indication feature is enabled on your radio (programmed by your dealer), you will hear a short alert tone the moment the target radio (the radio that is receiving your call) releases the **PTT** button, indicating the channel is free for you to respond.
-  You will also hear the Channel Free Indication tone if your call is interrupted, for example when the radio receives an Emergency Call.
You can turn off the Channel Free Indication tone or the **PTT** Sidetone  by disabling all radio tones and alerts (see **Turning the Radio Tones/Alerts On or Off** on page 80).

■ Switching Between Conventional Analog and Digital Mode

Each channel in your radio can be configured as a conventional analog or conventional digital channel. Use the Channel Selector Knob to switch between an analog or a digital channel.

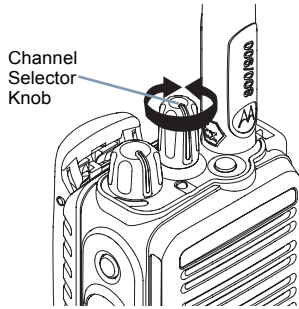

When switching from digital to analog mode, certain features are unavailable. Icons for the digital features (such as Messages) reflect this change by appearing 'grayed out'. Disabled features are hidden in the menu.

Your radio also has features available in both analog and digital mode. However, the minor differences in the way each feature works does **NOT** affect the performance of your radio.

NOTE: Your radio also switches between digital and analog modes during a dual mode scan (see **Scan** on page 36).

■ Capacity Plus

Capacity Plus is a single-site trunking configuration of the MOTOTRBO radio system, which uses a pool of channels to support hundreds of users and up to 254 Groups. This feature allows your radio to efficiently utilize the available number of programmed channels while in Repeater Mode.

You can **only** access channel(s) with Capacity Plus via the Channel Selector Knob, while features supported in Capacity Plus can be accessed via the menu and/or a programmable button press.

Icons of features not applicable to Capacity Plus will not be available in the menu. You will hear a negative indicator tone if you access a feature not applicable to Capacity Plus via a programmable button press.

Your radio also has features that are available in both conventional digital mode and Capacity Plus. However, the minor differences in the way each feature works does **NOT** affect the performance of your radio.

Check with your dealer or system administrator for more information on this system.

Identifying Status Indicators

Your radio indicates its operational status through the following:

Display Icons	page 13
Call Icons	page 14
Sent Item Icons	page 15
LED Indicator	page 15
Audio Tones	page 16
Indicator Tones	page 16

■ Display Icons

The full dot matrix, black and white, liquid crystal display (LCD) of your radio shows radio status, text entries, and menu entries.

The following are icons that appear on the radio's display.



Received Signal Strength Indicator (RSSI)

The number of bars displayed represents the radio signal strength. Four bars indicate the strongest signal. This icon is only displayed while receiving.



Monitor

Selected channel is being monitored.



Power Level

Radio is set at Low power.



Radio is set at High power.

Tones Disable

Tones are turned off.



Option Board

The Option Board is enabled.



Option Board Non-Function

The Option Board is disabled.



GPS Available 

The GPS feature is enabled. The icon stays lit when a position fix is available.



GPS Not Available/Out of Range 

The GPS feature is enabled but is not receiving data from the satellite.



Scan*

Scan feature is enabled.



Priority Scan*

Radio detects activity on channel/group designated as Priority 1 (if • is blinking) or Priority 2 (if • is steady).

* Not applicable in Capacity Plus

**Unread Message** 

User has unread message(s) in the Inbox.

**Inbox Full** 

User's Inbox is full.

**Emergency**

Radio is in Emergency mode.

**Secure** 

The Privacy feature is enabled.

**Unsecure** 

The Privacy feature is disabled.

**Site Roaming*** 

The site roaming feature is enabled.

**Talkaround***

In the absence of a repeater, radio is currently configured for direct radio to radio communication.

**Battery**

The number of bars (0 – 4) shown indicates the charge remaining in the battery.
Blinks when the battery is low.

■ Call Icons

The following icons appear on the radio's display during a call. These icons also appear in the Contacts list to indicate ID type.

**Private Call**

Indicates a Private Call in progress. In the Contacts list, it indicates a subscriber alias (name) or ID (number).

**Group Call/All Call**

Indicates a Group Call or All Call in progress. In the Contacts list, it indicates a group alias (name) or ID (number).

* Not applicable in Capacity Plus

■ Sent Item Icons

The following icons appear at the top right corner of the radio's display in the Sent Items folder.



Sent Successfully

The text message is sent successfully.



Send Failed

The text message cannot be sent.



In-Progress

- The text message to a group alias or ID is pending transmission.
- The text message to a subscriber alias or ID is pending transmission, followed by waiting for acknowledgement.

■ LED Indicator

The LED indicator shows the operational status of your radio.

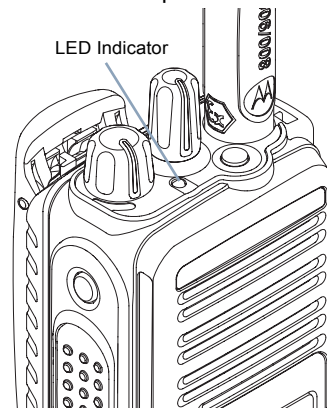

Blinking red – Radio is transmitting at low battery condition, receiving an emergency transmission or has failed the self-test upon powering up.

Solid yellow – Radio is monitoring a channel.

Blinking yellow – Radio is scanning for activity or receiving a Call Alert.

Double blinking yellow – Radio is no longer connected to the repeater while in Capacity Plus, all Capacity Plus channels are currently busy or in locked state.

Rapidly blinking yellow – Radio is actively searching for a new site. 

Solid green – Radio is transmitting.

Blinking green – Radio is powering up, receiving a non-privacy-enabled call or data, or detecting activity over the air.

Rapidly blinking green – Radio is receiving a privacy-enabled call or data. 

NOTE: While in conventional mode, when the LED blinks green, it indicates the radio detects activity over the air. Due to the nature of the digital protocol, this activity may or may not affect the radio's programmed channel.

For Capacity Plus, there is no LED indication when the radio is detecting activity over the air.

Upon a **PTT** button press, if the radio is programmed for polite operation, the radio automatically determines whether a transmission is permitted via a Talk Permit or a Talk Denial tone.

■ Audio Tones

Alert tones provide you with audible indications of the radio's status or the radio's response to data received.

Continuous Tone  A monotone sound. Sounds continuously until termination.

Periodic Tone  Sounds periodically depending on the duration set by the radio. Tone starts, stops, and repeats itself.

Repetitive Tone  A single tone that repeats itself until it is terminated by the user.

Momentary Tone  Sounds only once for a short period of time defined by the radio.

■ Indicator Tones

High pitched tone  Low pitched tone 

 Positive Indicator Tone

 Negative Indicator Tone

Making and Receiving Calls

Once you understand how your MOTOTRBO Portable is configured, you are ready to use your radio.

Use this navigation guide to familiarize yourself with the basic Call features:

Selecting a Site	page 17
Selecting a Zone	page 17
Selecting a Radio Channel, Subscriber ID, or Group ID	page 19
Receiving and Responding to a Radio Call	page 19
Making a Radio Call	page 22
Stopping a Radio Call	page 27
Talkaround	page 27
Monitoring Features	page 28

Selecting a Site

A site is a specific area where a base station is placed to provide optimal coverage for the radio.

If enabled, your radio is able to connect to different available sites via an Internet Protocol (IP) network.

See **IP Site Connect** on page 69 for more information.

Selecting a Zone

A zone is a group of channels. Your radio supports up to 250 zones, with a maximum of 16 channels per zone.





Use the following procedure to select a zone.

Procedure:

Press the programmed Zone button and proceed to Step 3.

OR

Follow the procedure below.

-  to access the menu.
-  or  to Zone and press  to select.
- The current zone is displayed and indicated by a ✓.

- 4  or  to the required zone and proceed to Step 7.

OR

Key in the first character of the required zone.

- 5 A blinking cursor appears.

Use the keypad to type the required zone.

Press  to move one space to the left.

Press  to move one space to the right.

Press the *DEL key to delete any unwanted characters.

- 6 The first line of the display shows the characters you keyed in. The second line of the display shows the required zone. The alias search is case-insensitive. If there are two or more zones with the same name, the radio displays the zone that is listed first in the zone list.
-

- 7 Press  to select.
-

- 8 The display shows <Zone> Selected momentarily and returns to the selected zone screen.
-

■ Selecting a Radio Channel, Subscriber ID, or Group ID

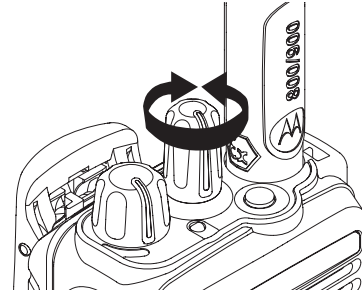

Procedure:

Once the required zone is displayed (if you have multiple zones in your radio), turn the programmed Channel Selector Knob to select the channel, subscriber alias or ID, or group alias or ID.

■ Receiving and Responding to a Radio Call

Once the channel, subscriber ID or group ID is displayed, you can proceed to receive and respond to calls.

The LED lights up solid green while the radio is transmitting and blinks green when the radio is receiving.

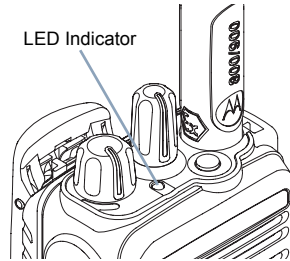

NOTE: The LED lights up solid green while the radio is transmitting and blinks green rapidly when the radio is receiving a privacy-enabled call.

To unscramble a privacy-enabled call, your radio must have the same Privacy Key, OR the same Key Value and Key ID (programmed by your dealer), as the transmitting radio (the radio you are receiving the call from).

See **Privacy** on page 68 for more information. 

📄 Receiving and Responding to a Group Call

To receive a call from a group of users, your radio must be configured as part of that group.



Procedure:

When you receive a Group Call (while on the Home screen):

- 1 The LED blinks green.

- 2 The first line of the display shows the caller alias, and the RSSI icon. The second line displays the group alias and the Group Call icon (in Digital mode only).

- 3 Hold the radio vertically 1 to 2 inches (2.5 to 5.0 cm) from your mouth.

- 4  If the Channel Free Indication feature is enabled, you will hear a short alert tone the moment the transmitting radio releases the **PTT** button, indicating the channel is free for you to respond. Press the **PTT** button to respond to the call.
OR
 If the Voice Interrupt feature is enabled, press the **PTT** button to stop the current call from the transmitting radio and free the channel for you to talk/respond.

- 5 The LED lights up solid green.

- 6 Wait for the Talk Permit Tone to finish (if enabled) and speak clearly into the microphone.
OR
 Wait for the **PTT** Sidetone to finish (if enabled) and speak clearly into the microphone.

- 7 Release the **PTT** button to listen.

- 8 If there is no voice activity for a predetermined period of time, the call ends.

See **Making a Group Call** on page 22 for details on making a Group Call.

NOTE: If the radio receives a Group Call while not on the Home screen, it remains on its current screen prior to answering the call.

Long press the  button to go to the Home screen to view the caller alias before replying.

Receiving and Responding to a Private Call

A Private Call is a call from an individual radio to another individual radio.

There are two types of Private Calls. The first type, where a radio presence check is performed prior to setting up the call, while the other sets up the call immediately.

When your radio is checked, the LED blinks green.

Only **one** of these call types can be programmed to your radio by your dealer.

Procedure:

When you receive a Private Call:

- 1 The LED blinks green.

- 2 The first line of the display shows the subscriber alias or ID, and the RSSI icon. The second line displays `Private Call` and the Private Call icon.

- 3 Hold the radio vertically 1 to 2 inches (2.5 to 5.0 cm) from your mouth.

- 4 If the Channel Free Indication feature is enabled, you will hear a short alert tone the moment the transmitting radio releases the **PTT** button, indicating the channel is free for you to respond.
Press the **PTT** button to respond to the call.
OR
If the Voice Interrupt feature is enabled, press the **PTT** button to stop the current call from the transmitting radio and free the channel for you to talk/respond.

- 5 The LED lights up solid green.

- 6 Wait for the Talk Permit Tone to finish (if enabled) and speak clearly into the microphone.

- 7 Release the **PTT** button to listen.

- 8 If there is no voice activity for a predetermined period of time, the call ends.

- 9 You hear a short tone. The display shows `Call Ended`.

See **Making a Private Call** on page 23 for details on making a Private Call.

Receiving an All Call

An All Call is a call from an individual radio to every radio on the channel. It is used to make important announcements requiring the user's full attention.

Procedure:

When you receive an All Call:

- 1 A tone sounds and the LED blinks green.

- 2 The first line of the display shows the caller alias, and the RSSI icon. The second line displays `All Call` and the All Call icon.

- 3 Once the All Call ends, the radio returns to the previous screen before receiving the call.
 -  If the Channel Free Indication feature is enabled, you will hear a short alert tone the moment the transmitting radio releases the **PTT** button, indicating the channel is now available for use.



You cannot respond to an All Call.

See **Making an All Call** on page 24 for details on making an All Call.

NOTE: The radio stops receiving the All Call if you switch to a different channel while receiving the call.
During an All Call, you will **not** be able to use any programmed button functions until the call ends.

■ Making a Radio Call

You can select a channel, subscriber ID, or group by using:

- The Channel Selector Knob
- A programmed **One Touch Access** button 
- The programmed number keys – This method is for Group, Private and All Calls only and is used with the keypad (see **Making a Group, Private or All Call with the Programmable Number Key** on page 26). 
- The Contacts list (see **Contacts Settings** on page 39)
- Manual Dial (via Contacts) – This method is for Private Calls only and is dialed using the keypad (see **Making a Private Call from Contacts** on page 40). 

NOTE: Your radio must have the Privacy feature enabled on the channel to send a privacy-enabled transmission. Only target radios with the same Privacy Key OR the same Key Value and Key ID as your radio will be able to unscramble the transmission.

See **Privacy** on page 68 for more information. 

Making a Call with the Channel Selector Knob

Making a Group Call

To make a call to a group of users, your radio must be configured as part of that group.

Procedure:

- 1 Turn the Channel Selector Knob to select the channel with the active group alias or ID.

- 2 Hold the radio vertically 1 to 2 inches (2.5 to 5.0 cm) from your mouth.

- 3 Press the **PTT** button to make the call. The LED lights up solid green. The display shows the group alias or ID, and the Group Call icon.

- 4 Wait for the Talk Permit Tone to finish (if enabled) and speak clearly into the microphone.

OR

-  Wait for the **PTT** Sidetone to finish (if enabled) and speak clearly into the microphone.

- 5 Release the **PTT** button to listen. When the target radio responds, the LED blinks green. You see the Group Call icon, the group alias or ID, and transmitting radio alias or ID on your display.

- 6  If the Channel Free Indication feature is enabled, you will hear a short alert tone the moment the target radio releases the **PTT** button, indicating the channel is free for you to respond. Press the **PTT** button to respond.
OR
If there is no voice activity for a predetermined period of time, the call ends.

- 7 Radio returns to the screen you were on prior to initiating the call.

You can also make a Group Call via Contacts (see **Making a Group Call from Contacts** on page 39).

Making a Private Call

While you can receive and/or respond to a Private Call initiated by an authorized individual radio, your radio must be programmed for you to initiate a Private Call.

You will hear a negative indicator tone, when you make a Private Call via the Contacts list, Call Log, **One Touch Access** button, the programmed number keys, or the Channel Selector Knob, if this feature is not enabled.

Use the Text Message or Call Alert features to contact an individual radio. See **Text Message Features** on page 56 or **Call Alert Operation** on page 49 for more information.

Procedure:

- 1 Turn the Channel Selector Knob to select the channel with the active subscriber alias or ID.

- 2 Hold the radio vertically 1 to 2 inches (2.5 to 5.0 cm) from your mouth.

- 3 Press the **PTT** button to make the call. The LED lights up solid green. The first line displays the subscriber alias or ID. The second line displays **Private Call** and the Private Call icon.

- 4 Wait for the Talk Permit Tone to finish (if enabled) and speak clearly into the microphone.

- 5 Release the **PTT** button to listen. When the target radio responds, the LED blinks green.

- 6 If the Channel Free Indication feature is enabled, you will hear a short alert tone the moment the target radio releases the **PTT** button, indicating the channel is free for you to respond. Press the **PTT** button to respond.
OR
If there is no voice activity for a predetermined period of time, the call ends.

- 7 You hear a short tone. The display shows `Call Ended`.

*You can also make a Private Call via Contacts (see **Making a Private Call from Contacts** on page 40) or perform a quick alphanumeric search for the required alias via a keypad entry (see **Making a Call by Alias Search** on page 41).*

Making an All Call

This feature allows you to transmit to all users on the channel. Your radio must be programmed to allow you to use this feature.

Procedure:

- 1 Turn the Channel Selector Knob to select the channel with the active All Call group alias or ID.

- 2 Hold the radio vertically 1 to 2 inches (2.5 to 5.0 cm) from your mouth.

- 3 Press the **PTT** button to make the call. The LED lights up solid green. The display shows the All Call group alias or ID, and the All Call icon.

- 4 Wait for the Talk Permit Tone to finish (if enabled) and speak clearly into the microphone.
OR
 Wait for the **PTT** Sidetone to finish (if enabled) and speak clearly into the microphone.

Users on the channel cannot respond to an All Call.

Making a Group or Private Call with the One Touch Access Button

The One Touch Access feature allows you to make a Group or Private Call to a predefined alias or ID easily. This feature can be assigned to a short or long programmable button press.

You can **ONLY** have one alias or ID assigned to a **One Touch Access** button. Your radio can have multiple **One Touch Access** buttons programmed.

Procedure:

- 1 Press the programmed **One Touch Access** button to make a Group or Private Call to the predefined alias or ID.
- 2 Hold the radio vertically 1 to 2 inches (2.5 to 5.0 cm) from your mouth.
- 3 Press the **PTT** button to make the call. The LED lights up solid green. The display shows the group/subscriber alias or ID, and the Group/Private Call icon.

- 4 Wait for the Talk Permit Tone to finish (if enabled) and speak clearly into the microphone.

OR

 **For Group Call only:** Wait for the **PTT** Sidetone to finish (if enabled) and speak clearly into the microphone.

- 5 Release the **PTT** button to listen. When the target radio responds, the LED blinks green.
 - 6 If the Channel Free Indication feature is enabled, you will hear a short alert tone the moment the target radio releases the **PTT** button, indicating the channel is free for you to respond. Press the **PTT** button to respond.
- OR**
- If there is no voice activity for a predetermined period of time, the call ends.
- 7 Radio returns to the screen you were on prior to initiating the call.

For a Private Call, you hear a short tone when the call ends.

Making a Group, Private or All Call with the Programmable Number Key

The Programmable Number Key feature allows you to make a Group, Private or All Call to a predefined alias or ID easily. This feature can be assigned to all the available number keys on a keypad.

You can **ONLY** have one alias or ID assigned to a number key, but you can have more than one number key associated to an alias or ID.

Procedure:

When you are on the Home screen:

- 1 Long press the programmed number key to make a Group, Private or All Call to the predefined alias or ID. If the number key is not associated to an entry, a negative indicator tone sounds.
- 2 Hold the radio vertically 1 to 2 inches (2.5 to 5.0 cm) from your mouth.
- 3 Press the **PTT** button to make the call. The LED lights up solid green. The display shows the group/subscriber alias or ID, and the Group/Private/All Call icon.

- 4 Wait for the Talk Permit Tone to finish (if enabled) and speak clearly into the microphone.

OR

 **For Group Call only:** Wait for the **PTT** Sidetone to finish (if enabled) and speak clearly into the microphone.

- 5 Release the **PTT** button to listen. When the target radio responds, the LED blinks green.
- 6 If the Channel Free Indication feature is enabled, you will hear a short alert tone the moment the target radio releases the **PTT** button, indicating the channel is free for you to respond. Press the **PTT** button to respond.

OR

If there is no voice activity for a predetermined period of time, the call ends.

- 7 Radio returns to the screen you were on prior to initiating the call.

For a Private Call, you hear a short tone when the call ends.

*See **Assigning an Entry to a Programmable Number Key** on page 43 for details on assigning an entry to a number key on the keypad.*

■ Stopping a Radio Call

This feature allows you to stop an ongoing Group or Private Call to free the channel for transmission. For example, when a radio experiences a “stuck microphone” condition where the **PTT** button is inadvertently pressed by the user.

Your radio must be programmed to allow you to use this feature.

Procedure:

While on the required channel:

- 1 Press the programmed **Transmit Interrupt Remote Dekey** button.
- 2 The display shows *Remote Dekey*.
- 3 Wait for acknowledgment.
- 4 The radio sounds a positive indicator tone and the display shows *Remote Dekey Success*, indicating that the channel is now free.

OR

The radio sounds a negative indicator tone and the display shows *Remote Dekey Failed*.

*The display shows **Call Interrupted**, and the radio sounds a negative indicator tone until you release the **PTT** button, if it is transmitting an interruptible call that is stopped via this feature.*

■ Talkaround

You can continue to communicate when your repeater is not operating, or when your radio is out of the repeater’s range but within talking range of other radios.

This is called “talkaround”.











NOTE: This feature is not applicable in Capacity Plus.

Procedure:

Press the programmed **Repeater/Talkaround** button to toggle between talkaround and repeater modes.

OR

Follow the procedure below.

- 1  to access the menu.
- 2  or  to *Utilities* and press  to select.
- 3  or  to *Radio Settings* and press  to select.
- 4  or  to *Talkaround* and press  to select.
- 5 You see *Turn On* if the radio is currently in Repeater mode.
OR
You see *Turn Off* if the radio is currently in Talkaround mode.

- 6 Press  to select.

- 7 The display shows `Talkaround On`.
OR
The display shows `Talkaround Off`.

- 8 The screen automatically returns to the previous menu.

The Talkaround setting is retained even after powering down.

■ Monitoring Features

Monitoring a Channel

Use the Monitor feature to make sure a channel is clear before transmitting.

Procedure:

- 1 Press and hold the programmed **Monitor** button and listen for activity.

- 2 The monitor icon appears on the display and the LED lights up solid yellow.

- 3 You hear radio activity or total silence, depending on how your radio is programmed.

- 4 When you hear “white noise” (that is, the channel is free), press the **PTT** button to talk and release it to listen.

Permanent Monitor

Use the Permanent Monitor feature to continuously monitor a selected channel for activity.

NOTE: This feature is not applicable in Capacity Plus.

Procedure:

- 1 Press the programmed **Permanent Monitor** button.

- 2 Radio sounds an alert tone, the LED lights up solid yellow, and the display shows `Permanent Monitor On`. The monitor icon appears on the display.

- 3 Press the programmed **Permanent Monitor** button to exit Permanent Monitor mode.

- 4 Radio sounds an alert tone, the LED turns off, and display shows `Permanent Monitor Off`.

Advanced Features

Use this navigation guide to learn more about advanced features available with your radio:

Radio Check	page 29
Remote Monitor	page 31
Scan Lists	page 33
Scan	page 36
Contacts Settings	page 39
Call Indicator Settings	page 44
Call Log Features	page 47
Call Alert Operation	page 49
Emergency Operation	page 50
Text Message Features	page 56
Privacy	page 68
Dual Tone Multi Frequency (DTMF)	page 69
IP Site Connect	page 69
Security	page 72
Lone Worker	page 74
Password Lock Features	page 74
Utilities	page 77

Radio Check



If enabled, this feature allows you to determine if another radio is active in a system without disturbing the user of that radio. No audible or visual notification is shown on the target radio.

This feature is only applicable for subscriber aliases or IDs.

Sending a Radio Check

Procedure:

Use the programmed **Radio Check** button.

- 1 Press the programmed **Radio Check** button.
- 2  or  to the required subscriber alias or ID and press  to select.
- 3 The display shows **Radio Check: <Subscriber Alias or ID>**, indicating that Radio Check is in progress. The LED lights up solid green.
- 4 Wait for acknowledgement.

- 5 If the target radio is active in the system, a tone sounds and the display briefly shows Target Radio Available.

OR







If the target radio is not active in the system, a tone sounds and the display briefly shows Target Radio Not Available.

- 6 Radio returns to the subscriber alias or ID screen.
-



OR

Procedure:

Use the menu.





- 1  to access the menu.
-
- 2  or  to `Contacts` and press  to select.
-
- 3  or  to the required subscriber alias or ID and press  to select.

OR

 or  to `Manual Dial` and press  to select.

If there was previously dialed ID, the ID appears along with a blinking cursor. Use the keypad to edit the ID. Press  to select.

OR

 or  to `Manual Dial` and press  to select. Key in the subscriber alias or ID and press .

- 4  or  to `Radio Check` and press  to select.
-

- 5 The display shows `Radio Check: <Subscriber Alias or ID>`, indicating that Radio Check is in progress. The LED lights up solid green.
-

- 6 Wait for acknowledgement.
-

- 7 If the target radio is active in the system, a tone sounds and the display briefly shows Target Radio Available.

OR

If the target radio is not active in the system, a tone sounds and the display briefly shows Target Radio Not Available.

- 8 Radio returns to the subscriber alias or ID screen.
-

If the  button is pressed when the radio is waiting for acknowledgement, a tone sounds, and the radio terminates all retries and exits Radio Check mode.

■ Remote Monitor

Use the Remote Monitor feature to turn on the microphone of a target radio (subscriber alias or IDs only). No audible or visual indication is given to the target radio. You can use this feature to monitor, remotely, any audible activity surrounding the target radio.



Your radio must be programmed to allow you to use this feature.

Initiating Remote Monitor

Procedure:

Use the programmed **Remote Monitor** button.

- 1 Press the programmed **Remote Monitor** button.

- 2  or  to the required subscriber alias or ID and press  to select.

- 3 Radio sounds an alert tone and the LED blinks green.

- 4 Wait for acknowledgment.

- 5 The display shows `Remote Monitor Successful`.
OR
 The display shows `Remote Monitor Failed`.



- 6 If successful:
 The radio starts receiving audio from the monitored radio for a programmed duration.
 Once the timer expires, the radio sounds an alert tone and the LED turns off. The display shows `Remote Monitor Ended`.
OR
 If unsuccessful:
 The radio repeats the attempt until the programmed number of tries expires.







OR





Procedure:



Use the menu.

- 1  to access the menu.

- 2  or  to `Contacts` and press  to select.

- 3  or  to the required subscriber alias or ID and press  to select.
OR
 or  to `Manual Dial` and press  to select.
 If there was previously dialed ID, the ID appears along with a blinking cursor. Use the keypad to edit the ID. Press  to select.

- OR**
 or  to `Manual Dial` and press  to select. Key in the subscriber alias or ID and press  to select.

- 4  or  to Remote Mon. and press  to select.

- 5 Radio sounds an alert tone and the LED blinks green.

- 6 Wait for acknowledgment.

- 7 The display shows Remote Monitor Successful.
OR
The display shows Remote Monitor Failed.

- 8 If successful:
The radio starts receiving audio from the monitored radio for a programmed duration.
Once the timer expires, the radio sounds an alert tone and the LED turns off. The display shows Remote Monitor Ended.
OR
If unsuccessful:
The radio repeats the attempt until the programmed number of tries expires.

Stopping Remote Monitor

Procedure:

- 1 Press the programmed **Transmit Interrupt Remote Dekey** button.

- 2 The display shows Remote Dekey.

- 3 Wait for acknowledgment.

- 4 The radio sounds a positive indicator tone and the display shows Remote Dekey Success, indicating that the channel is now free.
OR
The radio sounds a negative indicator tone and the display shows Remote Dekey Failed.

■ Scan Lists

Scan lists are created and assigned to individual channels/groups. Your radio scans for voice activity by cycling through the channel/group sequence specified in the scan list for the current channel/group.

Your radio can support up to 250 scan lists, with a maximum of 16 members in a list. Each scan list supports a mixture of both analog and digital entries.



You can add, delete, or prioritize channels by editing a scan list.



NOTE: This feature is not applicable in Capacity Plus.



📄 Viewing an Entry in the Scan List

Procedure:

- 1  to access the menu.

- 2  or  to Scan and press  to select.

- 3  or  to View/Edit List and press  to select.

- 4 Use  or  to view each member on the list.



*The priority icon appears left of the member's alias, if set, to indicate whether the member is on a Priority 1 or Priority 2 channel list. You **cannot** have multiple Priority 1 or Priority 2 channels in a scan list.*



*There is no priority icon if priority is set to **None**.*

📄 Viewing an Entry in the Scan List by Alias Search



Procedure:

- 1  to access the menu.

- 2  or  to Scan and press  to select.

- 3  or  to View/Edit List and press  to select.

- 4 Key in the first character of the required alias.

- 5 A blinking cursor appears.
Use the keypad to type the required alias.
Press  to move one space to the left.
Press  to move one space to the right.
Press the *DEL key to delete any unwanted characters.















- 6 The first line of the display shows the characters you keyed in. The second line of the display shows the required alias.

The alias search is case-insensitive. If there are two or more entries with the same name, the radio displays the entry that is listed first in the scan list.



Editing the Scan List

Adding a New Entry to the Scan List



Procedure:

- 1  to access the menu.
- 2  or  to Scan and press  to select.
- 3  or  to View/Edit List and press  to select.
- 4  or  to Add Member and press  to select.
- 5  or  to the required alias or ID and proceed to Step 8.
OR
Key in the first character of the required alias.
- 6 A blinking cursor appears.
Use the keypad to type the required alias.
Press  to move one space to the left.
Press  to move one space to the right.
Press the *DEL key to delete any unwanted characters.
- 7 The first line of the display shows the characters you keyed in. The second line of the display shows the required alias.
The alias search is case-insensitive. If there are two or more aliases with the same name, the radio displays the alias that is listed first in the list.

8 Press  to select.

9  or  to the required priority level and press  to select.

10 The display shows Entry Saved, followed immediately by Add Another?.









11  or  to Yes and press  to select, to add another entry, and repeat Steps 5 to 9.



OR

 or  to No and press  to select to save the current list.

Deleting an Entry from the Scan List



Procedure:







- 1  to access the menu.
- 2  or  to Scan and press  to select.
- 3  or  to View/Edit List and press  to select.
- 4  or  to the required alias or ID and proceed to Step 7.
OR
Key in the first character of the required alias.

- 5 A blinking cursor appears.
Use the keypad to type the required alias.
Press  to move one space to the left.
Press  to move one space to the right.
Press the *DEL key to delete any unwanted characters.

- 6 The first line of the display shows the characters you keyed in. The second line of the display shows the required alias. The alias search is case-insensitive. If there are two or more entries with the same name, the radio displays the entry that is listed first in the scan list.

- 7 Press  to select.

- 8  or  to Delete and press  to select.

- 9 At Delete Entry?,  or  to Yes and press  to select, to delete the entry. The display shows Entry Deleted.
OR
 or  to No and press  to select to return to the previous screen.



- 10 Repeat Steps 4 to 9 to delete other entries.



After deleting all required aliases or IDs, long press  to return to the Home screen.



Setting and Editing Priority for an Entry in the Scan List



Procedure:

- 1  to access the menu.

- 2  or  to Scan and press  to select.



- 3  or  to View/Edit List and press  to select.



- 4  or  to the required alias or ID and proceed to Step 7.
OR
Key in the first character of the required alias.

- 5 A blinking cursor appears.
Use the keypad to type the required alias.
Press  to move one space to the left.
Press  to move one space to the right.
Press the *DEL key to delete any unwanted characters.

- 6 The first line of the display shows the characters you keyed in. The second line of the display shows the required alias. The alias search is case-insensitive. If there are two or more entries with the same name, the radio displays the entry that is listed first in the scan list.

- 7 Press  to select.

- 8  or  to Edit Priority and press  to select.

- 9  or  to the required priority level and press  to select.

- 10 The display shows *Entry Saved* before returning to the previous screen.

- 11 The priority icon appears left of the member's name.

*There is no priority icon if priority is set to **None**.*

■ Scan

When you start a scan, your radio cycles through the programmed scan list for the current channel looking for voice activity.

The LED blinks yellow and you see the scan icon on the display.

During a dual mode scan, if you are on a digital channel, and your radio locks onto an analog channel, it automatically switches from digital mode to analog mode for the duration of the call. This is also true for the reverse.

There are two ways of initiating scan:

- **Main Channel Scan (Manual):** Your radio scans all the channels/groups in your scan list. On entering scan, your radio may – depending on the settings – automatically start on the last scanned “active” channel/group or on the channel where scan was initiated.
- **Auto Scan (Automatic):** Your radio automatically starts scanning when you select a channel/group that has Auto Scan enabled.

NOTE: This feature is not applicable in Capacity Plus.

Starting and Stopping Scan

Procedure:



Press the programmed **Scan** button to start or stop Scan.

OR

Follow the procedure below.

- 1 Use the Channel Selector Knob to select a channel programmed with a scan list.

- 2  to access the menu.

- 3  or  to Scan and press  to select.

- 4 The display shows **Turn On** if scan is disabled.
OR
The display shows **Turn Off** if scan is enabled.

- 5 Press  to select.

- 6 The LED blinks yellow and the scan icon is displayed when Scan is enabled.
OR
The LED turns off and the scan icon is not displayed when Scan is disabled.

While scanning, the radio will only accept data (e.g. text message, location, telemetry, or PC data) if received on its Selected Channel.

Responding to a Transmission During a Scan

During scanning, your radio stops on a channel/group where activity is detected. The radio stays on that channel for a programmed time period known as “hang time”.

Procedure:

- 1 Hold the radio vertically 1 to 2 inches (2.5 to 5.0 cm) from your mouth.
 If the Channel Free Indication feature is enabled, you will hear a short alert tone the moment the transmitting radio releases the **PTT** button, indicating the channel is free for you to respond.

- 2 Press the **PTT** button during hang time. The LED lights up solid green.

- 3 Wait for the Talk Permit Tone to finish (if enabled) and speak clearly into the microphone.
OR
 Wait for the **PTT** Sidetone to finish (if enabled) and speak clearly into the microphone.

- 4 Release the **PTT** button to listen.

- 5 If you do not respond within the hang time, the radio returns to scanning other channels/groups.

Deleting a Nuisance Channel

If a channel continually generates unwanted calls or noise (termed a “nuisance” channel), you can temporarily remove the unwanted channel from the scan list.

This capability does not apply to the channel designated as the Selected Channel.

Procedure:

- 1 When your radio “locks on to” an unwanted or nuisance channel, press the programmed **Nuisance Channel Delete** button until you hear a tone.
- 2 Release the **Nuisance Channel Delete** button. The nuisance channel is deleted.

*Deleting a “nuisance” channel is **only** possible through the programmed **Nuisance Channel Delete** button. This feature is **not** accessible through the menu.*

Restoring a Nuisance Channel

Procedure:

To restore the deleted nuisance channel, do **one** of the following:

- Turn the radio off and then power it on again, **OR**
- Stop and restart a scan via the programmed **Scan** button or menu, **OR**
- Change the channel via the Channel Selector Knob.

■ Contacts Settings

Contacts provides “address-book” capabilities on your radio. Each entry corresponds to an alias or ID that you use to initiate a call.

Each entry, depending on context, associates with **one** of five types of calls: Group Call, Private Call, All Call, PC Call or Dispatch Call.

PC Call and Dispatch Call are data-related. They are only available with the applications. Refer to the data applications documentation for more information.

NOTE: If the Privacy feature is enabled on a channel, you can make privacy-enabled Group Call, Private Call, and All Call on that channel. Only target radios with the same Privacy Key OR the same Key Value and Key ID as your radio will be able to unscramble the transmission.

See **Privacy** on page 68 for more information. 

Additionally, Contacts menu allows you to assign each entry to a programmable number key or more on a keypad. If an entry is assigned to a number key, your radio can perform a quick dial on the entry. 

Your radio supports two Contacts lists, one for Analog contacts and one for Digital contacts, with a maximum of 500 members for each Contacts list.

Each entry within Contacts displays the following information:

- Call Type
- Call Alias
- Call ID



NOTE: You can add, delete, or edit subscriber IDs for the Digital Contacts list.



For the Analog Contacts list, you can only view the list and initiate a Call Alert. Adding, deleting, and editing capabilities can only be performed by your dealer.

Making a Group Call from Contacts

Procedure:

- 1  to access the menu.

- 2  or  to **Contacts** and press  to select. The entries are alphabetically sorted.

- 3  or  to the required group alias or ID.

- 4 Hold the radio vertically 1 to 2 inches (2.5 to 5.0 cm) from your mouth.

- 5 Press the **PTT** button to make the call. The LED lights up solid green. The display shows the group alias or ID, and the Group Call icon.

- 6 Wait for the Talk Permit Tone to finish (if enabled) and speak clearly into the microphone.
OR
 Wait for the **PTT** Sidetone to finish (if enabled) and speak clearly into the microphone.



- 7 Release the **PTT** button to listen. When any user in the group responds, the LED blinks green. You see the Group Call icon, the group ID, and that user's ID on your display.









- 8  If the Channel Free Indication feature is enabled, you will hear a short alert tone the moment the target radio releases the **PTT** button, indicating the channel is free for you to respond. Press the **PTT** button to respond.
OR
If there is no voice activity for a programmed period of time, the call ends.

Making a Private Call from Contacts

Procedure:

- 1  to access the menu.

- 2  or  to **Contacts** and press  to select. The entries are alphabetically sorted.

- 3  or  to the required subscriber alias or ID.
OR
 or  to **Manual Dial** and press  to select. If there was previously dialed subscriber alias or ID, the alias or ID appears along with a blinking cursor. Use the keypad to edit the ID.
OR
 or  to **Manual Dial** and press  to select. Use the keypad to enter a new subscriber alias or ID.

- 4 Hold the radio vertically 1 to 2 inches (2.5 to 5.0 cm) from your mouth.

- 5 Press the **PTT** button to make the call. The LED lights up solid green. The first line displays the subscriber alias or ID. The second line displays `Private Call` and the Private Call icon.

 - 6 Wait for the Talk Permit Tone to finish (if enabled) and speak clearly into the microphone.

 - 7 Release the **PTT** button to listen. When the target radio responds, the LED blinks green and the display shows the transmitting user's ID.

 - 8 If the Channel Free Indication feature is enabled, you will hear a short alert tone the moment the target radio releases the **PTT** button, indicating the channel is free for you to respond. Press the **PTT** button to respond.
- OR**
- If there is no voice activity for a programmed period of time, the call ends.
-
- 9 You hear a short tone. The display shows `Call Ended`.
-



Making a Call by Alias Search

You can also use alias or alphanumeric search to retrieve the required subscriber alias.



This feature is only applicable while in Contacts.

Procedure:

- 1  to access the menu.

- 2  or  to `Contacts` and press  to select. The entries are alphabetically sorted.

- 3 Key in the first character of the required alias.

- 4 A blinking cursor appears.
Use the keypad to type the required alias.
Press  to move one space to the left.
Press  to move one space to the right.
Press the *DEL key to delete any unwanted characters.

- 5 The first line of the display shows the characters you keyed in. The second line of the display shows the required alias. The alias search is case-insensitive. If there are two or more entries with the same name, the radio displays the entry that is listed first in the Contacts list.

- 6 Hold the radio vertically 1 to 2 inches (2.5 to 5.0 cm) from your mouth.



- 7 Press the **PTT** button to make the call. The LED lights up solid green. The first line displays the target radio's ID. The second line displays `Private Call` and the Private Call icon.

- 8 Wait for the Talk Permit Tone to finish (if enabled) and speak clearly into the microphone.

- 9 Release the **PTT** button to listen. When the target radio responds, the LED blinks green.

- 10 If the Channel Free Indication feature is enabled, you will hear a short alert tone the moment the target radio releases the **PTT** button, indicating the channel is free for you to respond. Press the **PTT** button to respond.
OR
If there is no voice activity for a programmed period of time, the call ends.

- 11 You hear a short tone. The display shows `Call Ended`.

NOTE: Press  button or  to exit alias search.

If you release the **PTT** button while the radio is setting up the call, it exits without any indication and returns to the previous screen.



Your radio may be programmed to perform a radio presence check prior to setting up the Private Call. If the target radio is not available, you hear a short tone and see `Party Not Available` on the display.



The radio returns to the menu prior to initiating the radio presence check.



Assigning an Entry to a Programmable Number Key



Procedure:

- 1  to access the menu.

- 2  or  to `Contacts` and press  to select. The entries are alphabetically sorted.



- 3  or  to the required alias or ID and press  to select.

- 4  or  to `Program Key` and press  to select.

- 5  or  to the desired number key and press  to select.

OR

If the number key is currently assigned to another entry, the display shows `The Key is Already Assigned` and then, the first line of the display shows `Overwrite?`.

 or  to `Yes` and press  to select.

- 6 The radio sounds a positive indicator tone and the display shows `Contact Saved`.

- 7 The screen automatically returns to the previous menu.

NOTE: Each entry can be associated to different number keys. You see a checkmark before each number key that is assigned to an entry. If the checkmark is before `Empty`, you have not assign a number key to the entry.

If a number key is assigned to an entry in a particular mode, this feature is not supported when you long press the number key in another mode.

See ***Making a Group, Private or All Call with the Programmable Number Key*** on page 26 for details on making a *Group, Private or All Call with the programmed number key(s)*.

📄 Removing the Association between Entry and Programmable Number Key 🗣️



Procedure:



Long press the programmed number key to the required alias or ID, press **OK** to select, and proceed to Step 4.



OR



Follow the procedure below.

- 1  to access the menu.



- 2  or  to *Contacts* and press **OK** to select. The entries are alphabetically sorted.

- 3  or  to the required alias or ID and press **OK** to select.

- 4  or  to *Program Key* and press **OK** to select.

- 5  or  to *Empty* and press **OK** to select.

- 6 The first line of the display shows *Clear from all keys?*

- 7  or  to *Yes* and press **OK** to select.

- 8 The radio sounds a positive indicator tone and the display shows *Contact Saved*.

- 9 The screen automatically returns to the previous menu.

NOTE: When an entry is deleted, the association between the entry and its programmed number key(s) is removed.



■ Call Indicator Settings



📄 Activating and Deactivating Call Ringers for Private Calls 🗣️



You can turn on or off the ringing tones for a received Private Call.



Procedure:



- 1  to access the menu.

 - 2  or  to *Utilities* and press **OK** to select.

 - 3  or  to *Radio Settings* and press **OK** to select.

 - 4  or  to *Tones/Alerts* and press **OK** to select.

 - 5  or  to *Call Ringers* and press **OK** to select.

 - 6  or  to *Private Call* and press **OK** to select.



 - 7 The display shows *Turn On*. Press **OK** to enable Call Ringers for Private Calls. The display shows *Private Call Ringer On*.
- OR**
- The display shows *Turn Off*. Press **OK** to disable Call Ringers for Private Calls. The display shows *Private Call Ringer Off*.
-



Activating and Deactivating Call Ringers for Text Message



You can turn on or off the ringing tones for a received Text Message.



Procedure:



- 1  to access the menu.

- 2  or  to Utilities and press  to select.







- 3  or  to Radio Settings and press  to select.

- 4  or  to Tones/Alerts and press  to select.

- 5  or  to Call Ringers and press  to select.

- 6  or  to Text Message and press  to select.

- 7 The current tone is indicated by a ✓.



- 8  or  to the preferred tone and press  to select. The display shows Tone <Number> Selected and a ✓ appears left of the selected tone.
OR
 or  to Turn Off and press  to select. The display shows Text Message Ringer Off and a ✓ appears left of Turn Off.



Activating and Deactivating Call Ringers for Telemetry Status with Text



You can turn on or off the alert tones for a received Telemetry Status with Text.



Procedure:



- 1  to access the menu.

- 2  or  to Utilities and press  to select.







- 3  or  to Radio Settings and press  to select.

- 4  or  to Tones/Alerts and press  to select.

- 5  or  to Call Ringers and press  to select.

- 6  or  to Telemetry and press  to select.













- 7 The current tone is indicated by a ✓.

- 8  or  to the preferred tone and press  to select. The display shows Tone <Number> Selected and a ✓ appears left of the selected tone.
OR
 or  to Turn Off and press  to select. The display shows Telemetry Ringer Off and a ✓ appears left of Turn Off.

Assigning Ring Styles

You can program your radio to sound one of ten predefined ringing tones when receiving a Call Alert or a Text Message from a particular contact.

Procedure:















- 1  to access the menu.
- 2  or  to `Contacts` and press  to select. The entries are alphabetically sorted.
- 3  or  to the required alias or ID and press  to select.
- 4  or  to `Ring Style` and press  to select.
- 5 A ✓ indicates the current selected tone.
- 6  or  to the required tone and press  to select.
- 7 The display shows `Contact Saved`.

The radio sounds out each ring style as you navigate through the list.

Escalating Alarm Tone Volume

You can program your radio to continually alert you when a radio call remains unanswered. This is done by automatically increasing the alarm tone volume over time. This feature is known as Escalert.

Procedure:

- 1  to access the menu.
 - 2  or  to `Utilities` and press  to select.
 - 3  or  to `Radio Settings` and press  to select.
 - 4  or  to `Tones/Alerts` and press  to select.
 - 5  or  to `Escalert` and press  to select.
 - 6 The display shows `Turn On`. Press  to enable Escalert. The display shows `Escalert On`.
- OR**
- The display shows `Turn Off`. Press  to disable Escalert. The display shows `Escalert Off`.

■ Call Log Features

Your radio keeps track of all recent outgoing, answered, and missed Private Calls. Use the call log feature to view and manage recent calls.









You can perform the following tasks in each of your call lists:

- Store ID to Contacts
- Delete

Viewing Recent Calls

The lists are **Missed**, **Answered**, and **Outgoing**.

Procedure:

- 1  to access the menu.
- 2  or  to **Call Log** and press  to select.
- 3  or  to preferred list and press  to select.
- 4 The display shows the most recent entry at the top of the list.
- 5  or  to view the list.





Press the **PTT** button to start a Private Call with the current selected alias or ID.

Missed Call Screen

Whenever a call is missed, your radio displays a missed call message. Select **View** to view it immediately or **View Later** to view at a later time.















NOTE: The radio exits the Missed Call screen and sets up a Private Call if you press the **PTT** button while viewing a missed call number.

Procedure:

- 1 The display shows **Missed Calls**, along with the number of calls missed and **View?**.
 - 2 Press  to view the missed call ID. The missed call log list appears on display.
Press  to store or delete the entry.
- OR**
-  or  to **View Later** and press  to select. You return to the Home screen.

☰ Storing an Alias or ID from the Missed Call List

















Procedure:

- 1  to access the menu.
- 2  or  to Call Log and press  to select.
- 3  or  to Missed and press  to select.
- 4  or  to the required missed call alias or ID and press  to select.
- 5  or  to Store and press  to select.
- 6 A blinking cursor appears. If needed, key in the alias for that ID and press .
- 7 The display shows Contact Saved.

You can also store an ID without an alias.

☰ Deleting a Call from a Call List

Procedure:

- 1  to access the menu.
- 2  or  to Call Log and press  to select.
- 3  or  to the required list and press  to select.
- 4  or  to the required alias or ID and press  to select.
- 5  or  to Delete Entry? and press  to select.
- 6 Press  to select Yes to delete the entry. The display shows Entry Deleted.
OR
 or  to No to return to the previous screen.

When you select a call list and it contains no entries, the display shows *List Empty*, and sounds a low tone if Keypad Tones are turned on (see **Turning Keypad Tones On or Off** on page 77).

■ Call Alert Operation

Call Alert paging enables you to alert a specific radio user to call you back when they are able to do so.

This feature is applicable for subscriber aliases or IDs only and is accessible through the menu via Contacts or manual dial.

📄 Receiving and Responding to a Call Alert















When you receive a Call Alert page, you see `Call Alert` that alternates with the alias or ID of the calling radio on the display.

Procedure:

- 1 You hear a repetitive tone. The LED blinks yellow.
- 2 Press the **PTT** button within four (4) seconds of receiving a Call Alert page to respond to the Private Call.
OR
Press  to select `Ignore?` and to exit the Call Alert.

📄 Making a Call Alert from the Contacts List

Procedure:

- 1  to access the menu.
- 2  or  to `Contacts` and press  to select.
- 3  or  to the required subscriber alias or ID and press  to select.
OR
 or  to `Manual Dial` and press  to select.
A blinking cursor appears. Enter the subscriber ID you want to page and press .
- 4  or  to `Call Alert` and press  to select.
- 5 The display shows `Call Alert: <Subscriber Alias or ID>`, indicating that the Call Alert has been sent.
- 6 The LED lights up solid green when your radio is sending the Call Alert.
- 7 If the Call Alert acknowledgement is received, a tone sounds and the display shows `Call Alert Successful`.
OR
If the Call Alert acknowledgement is not received, a tone sounds and the display shows `Call Alert Failed`.

Making a Call Alert with the One Touch Access Button

Procedure:

- 1 Press the programmed **One Touch Access** button to make a Call Alert to the predefined alias or ID.
- 2 The display shows Call Alert: <Subscriber Alias or ID>, indicating that the Call Alert has been sent.
- 3 The LED lights up solid green when your radio is sending the Call Alert.
- 4 If the Call Alert acknowledgement is received, a tone sounds and the display shows Call Alert Successful.
OR
If the Call Alert acknowledgement is not received, a tone sounds and the display shows Call Alert Failed.

■ Emergency Operation

An Emergency Alarm is used to indicate a critical situation. You are able to initiate an Emergency at any time on any screen display even when there is activity on the current channel.

Your dealer can set the duration of a button press for the programmed **Emergency** button, except for long press, which is similar with all other buttons:

- Short press – Between 0.05 seconds and 0.75 seconds
- Long press – Between 1.00 second and 3.75 seconds

The **Emergency** button is assigned with the Emergency On/Off feature. Check with your dealer for the assigned operation of the **Emergency** button.

*If short press the **Emergency** button is assigned to turn on the Emergency mode, then long press the **Emergency** button is assigned to exit the Emergency mode.*

*If long press the **Emergency** button is assigned to turn on the Emergency mode, then short press the **Emergency** button is assigned to exit the Emergency mode.*

Your radio supports **three** Emergency Alarms:

- Emergency Alarm
- Emergency Alarm with Call
- Emergency Alarm with Voice to Follow 

In addition, each alarm has the following types:

- **Regular** – Radio transmits an alarm signal and shows audio and/or visual indicators.
- **Silent** – Radio transmits an alarm signal without any audio or visual indicators. Radio receives calls without any sound through the radio's speaker, until you press the **PTT** button to initiate the call.
- **Silent with Voice** – Radio transmits an alarm signal without any audio or visual indicators, but allow incoming calls to sound through the radio's speaker.

Only **ONE** of the Emergency Alarms above can be assigned to the programmed **Emergency** button.

Receiving an Emergency Alarm

Procedure:

- 1 When receiving an Emergency Alarm, the display shows the Emergency icon, the number of alarms received, and **Alarm** **Recd**, which alternates with the alias or ID of the sender.
- 2 A tone sounds and the LED blinks red.
- 3 Your radio automatically acknowledges the Emergency Alarm (if enabled).

When your radio receives an Emergency Alarm, it displays the Emergency Alarm received indications until acknowledgement is sent (if enabled) and you exit the Emergency mode.

You will not be able to receive any other indications or displays for any other calls until you exit the Emergency Alarm received screen.

NOTE: Press , then press **Emergency Off** button immediately to clear the Emergency Alarm received indications and exit Emergency mode.

Press , then press **Emergency On** button immediately to toggle the Emergency feature between hidden or shown.

When your radio receives an Emergency Alarm, and you change the radio channel, the Emergency Alarm list is hidden. The new channel displays the Emergency icon and the LED blinks red. When you change the radio channel back to the previous channel, it also displays the Emergency icon and the LED blinks red.

Responding to an Emergency Alarm

Procedure:

When receiving an Emergency Alarm:

- 1 Press any button to stop all Emergency Alarm received indications.

- 2 Hold the radio vertically 1 to 2 inches (2.5 to 5.0 cm) from your mouth.
 If the Channel Free Indication feature is enabled, you will hear a short alert tone the moment the transmitting radio releases the **PTT** button, indicating the channel is now available for use.

- 3 Press **PTT** button to transmit non-emergency voice to the same group that the Emergency Alarm was targeted to. The LED lights up solid green. Your radio remains in the Emergency mode.

- 4 Wait for the Talk Permit Tone to finish (if enabled) and speak clearly into the microphone.

OR

-  Wait for the **PTT** Sidetone to finish (if enabled) and speak clearly into the microphone.
-

- 5 Release the **PTT** button to listen. When the emergency initiating radio responds, the LED blinks green. You see the Group Call icon, the group ID, and transmitting radio ID on your display.

- 6 Once your call ends, press , then press **Emergency Off** button immediately to clear the Emergency Call received indications and exit Emergency mode.

- 7 The radio returns to the Home screen.

Emergency voice can only be transmitted by the emergency initiating radio. All other radios (including the emergency receiving radio) transmit non-emergency voice.

Sending an Emergency Alarm

This feature allows you to send an Emergency Alarm, a non-voice signal, which triggers an alert indication on a group of radios.

Procedure:

- 1 Press the programmed **Emergency On** button.
- 2 The display shows *Sending Alarm*, which alternates with your radio ID. The LED lights up solid green and the Emergency icon appears on the Home screen display.
- 3 When an Emergency Alarm acknowledgment is received, the Emergency tone sounds and the LED blinks green. The display shows *Emergency Alarm Successful*.
OR
If your radio does not receive an Emergency Alarm acknowledgement, and after all retries have been exhausted, a tone sounds and the display shows *Emergency Alarm Failed*.
- 4 Radio exits the Emergency Alarm mode and returns to the Home screen.

If your radio is set to Silent, it will not display any audio or visual indicators during Emergency mode.

Sending an Emergency Alarm with Call

This feature allows you to send an Emergency Alarm to a group of radios. Upon acknowledgement by a radio within the group, the group of radios can communicate over a programmed Emergency channel.

Procedure:

- 1 Press the programmed **Emergency On** button.
- 2 The display shows *Sending Alarm*, which alternates with your radio ID. The LED lights up solid green and the Emergency icon appears on the Home screen display.
- 3 When an Emergency Alarm acknowledgment is received, the Emergency tone sounds and the LED blinks green. The display shows *Emergency Alarm Successful*.
- 4 Hold the radio vertically 1 to 2 inches (2.5 to 5.0 cm) from your mouth.
- 5 Press **PTT** button to make the call. The LED lights up solid green and the group icon appears on the display.

- 6 Wait for the Talk Permit Tone to finish (if enabled) and speak clearly into the microphone.

OR

-  Wait for the **PTT** Sidetone to finish (if enabled) and speak clearly into the microphone.
-

- 7 Release the **PTT** button to listen.
-

- 8 When the channel is free for you to respond, a short alert tone sounds ( if the Channel Free Indication feature is enabled). Press the **PTT** button to respond.

OR

Once your call ends, press **Emergency Off** button to exit the Emergency mode.

- 9 The radio returns to the Home screen.
-

*If your radio is set to Silent, it will not display any audio or visual indicators during Emergency mode, or allow any received calls to sound through the radio's speaker, until you press the **PTT** button to initiate the call.*

*If your radio is set to Silent with Voice, it will not display any audio or visual indicators during Emergency mode, but allow incoming calls to sound through the radio's speaker. The indicators will only appear once you press the **PTT** button to initiate, or respond to, the call.*

Sending an Emergency Alarm with Voice to Follow

This feature allows you to send an Emergency Alarm to a group of radios. Your radio's microphone is automatically activated, allowing you to communicate with the group of radios without pressing the **PTT** button.

This activated microphone state is also known as "hot mic".

If you press the **PTT** button during the programmed hot mic transmission period, the radio ignores the **PTT** press and remains in Emergency mode.

NOTE: If you press the **PTT** button during hot mic, and continue to press it after the hot mic duration expires, the radio continues to transmit until you release the **PTT** button.

Procedure:

- 1 Press the programmed **Emergency On** button.
 - 2 The display shows `Sending Alarm`. The LED lights up solid green and the Emergency icon is displayed.
 - 3 Once the display shows `Emergency Alarm Successful`, speak clearly into the microphone. When hot mic has been enabled, the radio automatically transmits without a **PTT** press until the hot mic duration expires.
-

- 4 While transmitting, the LED lights up solid green and the Emergency icon appears on the display.
- 5 Once the hot mic duration expires, the radio automatically stops transmitting. To transmit again, press the **PTT** button.

*If your radio is set to Silent, it will not display any audio or visual indicators during Emergency mode, or allow any received calls to sound through the radio's speaker, until the programmed hot mic transmission period is over, and you press the **PTT** button.*

*If your radio is set to Silent with Voice, it will not display any audio or visual indicators during Emergency mode when you are making the call with hot mic, but allow sound through the radio's speaker when the target radio responds after the programmed hot mic transmission period is over. The indicators will only appear when you press the **PTT** button.*

NOTE: If the Emergency Alarm request fails, the radio does not retry to send the request, and enters the hot mic state directly.

Reinitiating an Emergency Mode

NOTE: This feature is only applicable to the radio sending the Emergency Alarm.

There are two instances where this can happen:

- You change the channel while the radio is in Emergency mode. This exits the Emergency mode. If Emergency Alarm is enabled on this new channel, the radio reinitiates Emergency.
- You press the programmed **Emergency On** button during an Emergency initiation/transmission state. This causes the radio to exit this state, and to reinitiate Emergency.

Exiting Emergency Mode

NOTE: This feature is only applicable to the radio sending the Emergency Alarm.

Your radio exits Emergency mode when **one** of the following occurs:

- Emergency Alarm acknowledgement is received (for **Emergency Alarm** only), **OR**
- All retries to send the alarm have been exhausted, **OR**
- The **Emergency Off** button is pressed.

NOTE: If your radio is powered off, it exits the Emergency mode. The radio will not reinitiate the Emergency mode automatically when it is turned on again.

■ Text Message Features

Your radio is able to receive data, for example a text message, from another radio or an e-mail application.

The **maximum** length of characters for a text message, including the subject line (seen when receiving message from an e-mail application), is **138**.

The radio exits the current screen once the inactivity timer expires. Any text message in the writing/editing screen will automatically be saved to the Drafts folder.

NOTE: Long press  at any time to return to the Home screen.







Writing and Sending a Text Message



















Procedure:

Press the programmed **Text Message** button and proceed to Step 3.

OR

Follow the procedure below.

- 1  to access the menu.
 - 2  or  to **Messages** and press  to select.
 - 3  or  to **Write** and press  to select.
-

- 4 A blinking cursor appears.
Use the keypad to type your message.
Press  to move one space to the left.
Press  or the # key to move one space to the right.
Press the *DEL key to delete any unwanted characters.
 - 5 Press  once message is composed.
 - 6  or  to **Send** and press  to send the message.
OR
 or  to **Save** and press  to save the message to the Drafts folder.
OR
 to edit the message.
 again to delete the message or save it to the Drafts folder.
 - 7  or  to the required alias or ID and press  to select.
OR
 or  to **Manual Dial** and press  to select.
Key in the subscriber ID and press .
 - 8 The display shows **Text Message: <Subscriber/Group Alias or ID>**, confirming your message is being sent.
-

9 If the message is sent, a tone sounds and the display shows Message Sent.

OR

If the message is not sent, a low tone sounds and the display shows Message Send Failed.

*If the text message fails to send, the radio returns you to the Resend option screen (see **Managing Fail-to-Send Text Messages** on page 60).*

Sending a Quick Text Message

Your radio supports a maximum of 50 Quick Text messages as programmed by your dealer.

While Quick Text messages are predefined, you can edit each message before sending it.

Procedure:

Press the programmed **Text Message** button and proceed to Step 3.



OR

Follow the procedure below.

1  to access the menu.

2  or  to Messages and press  to select.

3  or  to Quick Text and press  to select.

4  or  to the required Quick Text and press  to select.

5 A blinking cursor appears.



Use the keypad to edit the message, if required.

Press  to move one space to the left.



Press  or the # key to move one space to the right.

Press the *DEL key to delete any unwanted characters.

6 Press  once message is composed.

7  or  to Send and press  to send the message.



OR

 or  to Save and press  to save the message to the Drafts folder.



OR

 to edit the message.

 again to delete the message or save it to the Drafts folder.

8  or  to the required alias or ID and press  to select.

OR

 or  to Manual Dial and press  to select.

Key in the subscriber alias or ID and press .

9 The display shows Text Message: <Subscriber/Group Alias or ID>, confirming your message is being sent.

10 If the message is sent successfully, a tone sounds and the display shows *Message Sent*.

OR

If the message cannot be sent, a low tone sounds the display shows *Message Send Failed*.

*If the text message fails to send, the radio returns you to the Resend option screen (see **Managing Fail-to-Send Text Messages** on page 60).*

Sending a Quick Text Message with the One Touch Access Button

Procedure:

- 1** Press the programmed **One Touch Access** button to send a predefined Quick Text message to a predefined alias or ID.

 - 2** The display shows *Text Message: <Subscriber/Group Alias or ID>*, confirming your message is being sent.

 - 3** If the message is sent successfully, a tone sounds and the display shows *Message Sent*.
OR
If the message cannot be sent, the display shows *Message Send Failed*.
-

*If the text message fails to send, the radio returns you to the Resend option screen (see **Managing Fail-to-Send Text Messages** on page 60).*

Accessing the Drafts Folder

You can save a text message to send it at a later time.

If a **PTT** button press or a mode change causes the radio to exit the text message writing/editing screen while you are in the process of writing or editing a text message, your current text message is automatically saved to the Drafts folder.

The most recent saved text message is always added to the top of the Drafts list.

The Drafts folder stores a maximum of ten (10) last saved messages. When the folder is full, the next saved text message automatically replaces the oldest text message in the folder.

NOTE: Long press  at any time to return to the Home screen.

Viewing a Saved Text Message



Procedure:

Press the programmed **Text Message** button and proceed to Step 3.

OR

Follow the procedure below.

- 1**  to access the menu.

 - 2**  or  to *Messages* and press  to select.
-

- 3 or to Drafts and press to select.
- 4 or to the required message and press to select.

Editing and Sending a Saved Text Message

Procedure:

- 1 Press again while viewing the message.
- 2 or to Edit and press to select.
A blinking cursor appears.
Use the keypad to edit your message.
Press to move one space to the left.
Press or the # key to move one space to the right.
Press the *DEL key to delete any unwanted characters.
Press once message is composed.
OR
 or to Send and press to select.
- 3 or to the required alias or ID and press to select.
OR
 or to Manual Dial and press to select.
Key in the subscriber alias or ID and press .
- 4 The display shows Sending to: <Subscriber/Group Alias or ID>, confirming your message is being sent.

- 5 If the message is sent, a tone sounds and the display shows Message Sent.
OR
If the message is not sent, a low tone sounds and the display shows Message Send Failed.

If the text message fails to send, it is moved to the Sent Items folder and marked with a Send Failed icon.

Deleting a Saved Text Message from Drafts

Procedure:

Press the programmed **Text Message** button and proceed to Step 3.

OR

Follow the procedure below.

- 1 to access the menu.
- 2 or to Messages and press to select.
- 3 or to Drafts and press to select.
- 4 or to the required message and press to select.
- 5 or to Delete and press to delete the text message.

Managing Fail-to-Send Text Messages

You can select one of the following options while at the Resend option screen:

- Resend
- Forward
- Edit

NOTE: If the channel type (i.e. conventional digital or Capacity Plus) is not a match, you can only edit and forward a Fail-to-Send message.

Resending a Text Message

Procedure:



- 1 Press  to resend the same message to the same subscriber/group alias or ID.







 - 2 If the message is sent successfully, a tone sounds and the display shows `Message Sent`.
OR
If the message cannot be sent, the display shows `Message Send Failed`.
-

Forwarding a Text Message

Select Forward to send the message to another subscriber/group alias or ID.

Procedure:

- 1  or  to Forward and press  to select.

 - 2  or  to the required alias or ID and press  to select.
OR
 or  to Manual Dial and press  to select.
Key in the subscriber ID and press .

 - 3 The display shows `Text Message: <Subscriber/Group Alias or ID>`, confirming your message is being sent.



 - 4 If the message is sent, a tone sounds and the display shows `Message Sent`.
OR
If the message is not sent, a low tone sounds and the display shows `Message Send Failed`.
-



Editing a Text Message

Select **Edit** to edit the message before sending it.









NOTE: If a subject line is present (for messages received from an e-mail application), you cannot edit it.



Procedure:

- 1  or  to **Edit** and press  to select.





- 2 A blinking cursor appears beside the message.
Use the keypad to edit your message.
Press  to move one space to the left.
Press  or the # key to move one space to the right.
Press the *DEL key to delete any unwanted characters.

- 3 Press  once message is composed.

- 4  or  to **Send** and press  to send the message.
OR
 or  to **Save** and press  to save the message to the Drafts folder.
OR
 to edit the message.
 again to delete the message or save it to the Drafts folder.

- 5  or  to the required alias or ID and press  to select.

OR

-  or  to **Manual Dial** and press  to select.
Key in the subscriber ID and press .

- 6 The display shows **Text Message: <Subscriber/Group Alias or ID>**, confirming your message is being sent.

- 7 If the message is sent, a tone sounds and the display shows **Message Sent**.
OR
If the message is not sent, a low tone sounds and the display shows **Message Send Failed**.

Managing Sent Text Messages

Once a message is sent to another radio, it is saved in Sent Items. The most recent sent text message is always added to the top of the Sent Items list.

The Sent Items folder is capable of storing a maximum of thirty (30) last sent messages. When the folder is full, the next sent text message automatically replaces the oldest text message in the folder.

NOTE: Long press  at any time to return to the Home screen.

Viewing a Sent Text Message



Procedure:



Press the programmed **Text Message** button and proceed to Step 3.



OR

Follow the procedure below.

- 1  to access the menu.

- 2  or  to Messages and press  to select.

- 3  or  to Sent Items and press  to select.

- 4  or  to the required message and press  to select.
A subject line may be shown if the message is from an e-mail application.

*The icon at the top right corner of the screen indicates the status of the message (see **Sent Item Icons** on page 15).*

Sending a Sent Text Message



You can select one of the following options while viewing a sent text message:

- Resend
- Forward
- Edit
- Delete

NOTE: If the channel type (i.e. conventional digital or Capacity Plus) is not a match, you can only edit, forward, or delete a Sent message.

Procedure:



- 1 Press  again while viewing the message.

- 2  or  to Resend and press  to select.

- 3 The display shows Sending to: <Subscriber/Group Alias or ID>, confirming that the same message is being sent to the same target radio.



- 4 If the message is sent, a tone sounds and the display shows Message Sent.
OR
If the message is not sent, a low tone sounds and the display shows Message Send Failed.

If the message fails to send, the radio returns you to the *Resend* option screen. Press  to resend the message to the same subscriber/group alias or ID.

NOTE: Changing the volume, and pressing any button, except for , , or , returns you to the message.

The radio exits the *Resend* option screen if you press the **PTT** button to initiate a Private or Group Call, or to respond to a Group Call. The radio also exits the screen when it receives a text or telemetry message, an emergency call or alarm, or a call alert.

The display returns to the *Resend* option screen if you press the **PTT** button to respond to a Private Call (except when the radio is displaying the Missed Call screen), and at the end of an All Call.

Press  or  to access the *Forward*, *Edit*, or *Delete* option screen:

- Select *Forward* to send the selected text message to another subscriber/group alias or ID (see **Forwarding a Text Message** on page 60).

- Select *Edit* to edit the selected text message before sending it (see **Editing a Text Message** on page 61).
- Select *Delete* to delete the text message.

NOTE: If you exit the message sending screen while the message is being sent, the radio updates the status of the message in the Sent Items folder without providing any indication in the display or via sound.

If the radio changes mode or powers down before the status of the message in Sent Items is updated, the radio cannot complete any In-Progress messages and automatically marks it with a Send Failed icon.

The radio supports a maximum of five (5) In-Progress messages at one time. During this period, the radio cannot send any new message and automatically marks it with a Send Failed icon.











Deleting All Sent Text Messages from Sent Items

Procedure:



Press the programmed **Text Message** button and proceed to Step 3.

OR

Follow the procedure below.

- 1  to access the menu.
- 2  or  to Messages and press  to select.
- 3  or  to Sent Items and press  to select.
- 4  or  to Delete All and press  to select.
- 5 At Delete Message?, press  to select Yes. The display shows Sent Items Cleared.

OR

At Delete Message?,  or  to No and press  to return to the previous screen.

*When you select Sent Items and it contains no text messages, the display shows **List Empty**, and sounds a low tone if Keypad Tones are turned on (see **Turning Keypad Tones On or Off** on page 77).*

Receiving a Text Message

When your radio receives a message, the display shows the alias or ID of the sender and the message icon at the far left of the screen.





You can select one of the following options when receiving a text message:



- Read?
- Read Later
- Delete

NOTE: The radio exits the Text Message alert screen and sets up a Private or Group Call if the **PTT** button is pressed when the radio is displaying the alert screen.

Reading a Text Message

Procedure:

- 1  or  to Read? and press  to select.
 - 2 Selected message in the Inbox opens.
A subject line may be shown if the message is from an e-mail application.
 - 3 Press  to return to the Inbox.
- OR**
Press  to reply, forward, or delete the text message.

Press  or  to access the *Read Later* or *Delete* option screen:

- Select *Read Later* to return to the screen you were on prior to receiving the text message.
- Select *Delete* to delete the text message.

Managing Received Text Messages

Use the Inbox to manage your text messages. The Inbox is capable of storing a maximum of 30 messages.

Your radio supports the following options for text messages:

- Reply
- Forward
- Delete
- Delete All













NOTE: If the channel type (i.e. conventional digital or Capacity Plus) is not a match, you can only forward, delete, or delete all Received messages.

Text messages in the Inbox are sorted according to the most recently received.

NOTE: Long press  at any time to return to the Home screen.

Viewing a Text Message from the Inbox







Procedure:





- 1  to access the menu.
- 2  or  to *Messages* and press  to select.
- 3  or  to *Inbox* and press  to select.
- 4  or  to view the messages.
A subject line may be shown if the message is from an e-mail application.
- 5 Press  to select the current message, and press  again to reply, forward, or delete that message.
OR
Long press  to return to the Home screen.

Unread messages are indicated with an exclamation mark (!).

Viewing a Telemetry Status Text Message from the Inbox

Procedure:

- 1  to access the menu.
- 2  or  to *Messages* and press  to select.
- 3  or  to *Inbox* and press  to select.

- 4  or  to the required message and press  to select.
- 5 The display shows `Telemetry: <Status Text Message>`.
- 6 Long press  to return to the Home screen.

You cannot reply to a Telemetry Status text message.















Replying to a Text Message from the Inbox



Procedure:

Press the programmed **Text Message** button and proceed to Step 3.



OR

Follow the procedure below.

- 1  to access the menu.
- 2  or  to `Messages` and press  to select.
- 3  or  to `Inbox` and press  to select.
- 4  or  to the required message and press  to select.
A subject line may be shown if the message is from an e-mail application.
- 5 Press  once more to access the sub-menu.
- 6  or  to `Reply` and press  to select.

- 7  or  to `Write` and press  to select.
A blinking cursor appears. Use the keypad to write your message.

OR

-  or  to `Quick Text` and press  to select.
A blinking cursor appears. Use the keypad to edit your message, if required.

- 8 Press  once message is composed.
- 9 The display shows `Text Message: <Subscriber/Group Alias or ID>`, confirming your message is being sent.
- 10 If the message is sent successfully, a tone sounds and the display shows `Message Sent`.
OR
If the message cannot be sent, the display shows `Message Send Failed`.

*If the message fails to send, the radio returns you to the **Resend** option screen (see **Managing Fail-to-Send Text Messages** on page 60).*

Deleting a Text Message from the Inbox



Procedure:



Press the programmed **Text Message** button and proceed to Step 3.



OR

Follow the procedure below.



- 1  to access the menu.



- 2  or  to Messages and press  to select.

- 3  or  to Inbox and press  to select.

- 4  or  to the required message and press  to select.
A subject line may be shown if the message is from an e-mail application.

- 5 Press  once more to access the sub-menu.

- 6  or  to Delete and press  to select.

- 7 At Delete Message?,  or  to Yes and press  to select.

- 8 The display shows Message Deleted.

- 9 The screen returns to the Inbox.

Deleting All Text Messages from the Inbox



Procedure:



Press the programmed **Text Message** button and proceed to Step 3.



OR



Follow the procedure below.

- 1  to access the menu.

- 2  or  to Messages and press  to select.

- 3  or  to Inbox and press  to select.

- 4  or  to Delete All and press  to select.

- 5 At Delete Message?,  or  to Yes and press  to select.

- 6 The display shows Inbox Cleared.

*When you select the Inbox and it contains no text messages, the display shows *List Empty*, and sounds a low tone if Keypad Tones are turned on (see **Turning Keypad Tones On or Off** on page 77).*

■ Privacy

If enabled, this feature helps to prevent eavesdropping by unauthorized users on a channel by the use of a software-based scrambling solution. The signaling and user identification portions of a transmission are not scrambled.

Your radio must have privacy enabled on the channel to send a privacy-enabled transmission, although this is not a necessary requirement for receiving a transmission. While on a privacy-enabled channel, the radio is still able to receive clear (unscrambled) transmissions.

Your radio supports two types of privacy:

- Basic Privacy
- Enhanced Privacy.

Only **ONE** of the privacy types above can be assigned to the radio.

To unscramble a privacy-enabled call or data transmission, your radio must be programmed to have the same Privacy Key (for Basic Privacy), OR the same Key Value and Key ID (for Enhanced Privacy) as the transmitting radio.

If your radio receives a scrambled call that is of a different Privacy Key, OR a different Key Value and Key ID, you will either hear a garbled transmission (Basic Privacy) or nothing at all (Enhanced Privacy).

The LED lights up solid green while the radio is transmitting and blinks green rapidly when the radio is receiving an ongoing privacy-enabled transmission.













NOTE: Some radio models may not offer this Privacy feature. Check with your dealer or system administrator for more information.

Procedure:

Press the programmed **Privacy** button to toggle privacy on or off.

OR

Follow the procedure below.

- 1  to access the menu.
- 2  or  to Utilities and press  to select.
- 3  or  to Radio Settings and press  to select.
- 4  or  to Privacy and press  to select.
- 5 The display shows Privacy and Turn On. Press  to enable privacy. The display shows the secure icon and Privacy On.
OR
The display shows Privacy and Turn Off. Press  to disable privacy. The display shows the unsecure icon and Privacy Off.

If the radio has a privacy type assigned, the Home screen shows the secure or unsecure icon, except when the radio is sending or receiving an Emergency call or alarm.

■ Dual Tone Multi Frequency (DTMF)

The Dual Tone Multi Frequency (DTMF) feature allows the radio to operate in a radio system with an interface to telephone systems.

Procedure:

To initiate a DTMF call.

- 1 Press and hold the **PTT** button.
- 2 Enter the desired number, * or #.

*You can turn off the DTMF tone by disabling all radio tones and alerts (see **Turning the Radio Tones/Alerts On or Off** on page 80).*

■ IP Site Connect

This feature allows your radio to extend communication beyond the reach of a single site, by connecting to different available sites via an Internet Protocol (IP) network.

NOTE: This feature is not applicable in Capacity Plus.

When the radio moves out of range from one site and into the range of another, it connects to the new site's base station to send or receive calls/data transmissions. Depending on your settings, this is done automatically or manually.

If the radio is set to do this automatically, it scans through all available sites when the signal from the current site is weak or when the radio is unable to detect any signal from the current site. It then locks on to the base station with the strongest Received Signal Strength Indicator (RSSI) value.

In a manual site search, the radio searches for the next site in the roam list that is currently in range (but which may not have the strongest signal) and locks on to it.

NOTE: Each channel can only have either Scan or Roam enabled, not both at the same time.

Channels with this feature enabled can be added to a particular roam list. The radio searches the channel(s) in the Members list during the automatic roam operation to locate the best site.

A Members list supports a maximum of 16 channels (including the Selected Channel).

NOTE: You cannot manually add or delete an entry to the Members list. Check with your dealer or system administrator for more information.

Starting an Automatic Site Search

NOTE: The radio **only** scans for a new site if the current signal is weak or when the radio is unable to detect any signal from the current site. If the RSSI value is strong, the radio remains on the current site.

Procedure:













Press the programmed **Site Lock On/Off** button.

- 1 A tone sounds and the display shows `Site Unlocked`.
- 2 The LED blinks yellow rapidly when the radio is actively searching for a new site, and turns off once the radio locks on to a site.
- 3 The display shows the site roaming icon and channel alias.

OR

Procedure:

Use the menu.

- 1  to access the menu.
- 2  or  to `Utilities` and press  to select.
- 3  or  to `Radio Settings` and press  to select.
- 4  or  to `Site Roaming` and press  to select.
- 5  or  to `Unlock Site` and press  to select. A tone sounds and the display shows `Site Unlocked`.
- 6 The radio returns to the Home screen. The display shows the site roaming icon and channel alias.
- 7 The LED blinks yellow rapidly when the radio is actively searching for a new site, and turns off once the radio locks on to a site.

*The radio also performs an automatic site search (site is unlocked) during a **PTT** button press or data transmission if the current channel, an IP Site Select channel with an attached roam list, is out of range.*

Stopping an Automatic Site Search

When the radio is actively searching for a new site:

Procedure:













Press the programmed **Site Lock On/Off** button.

- 1 A tone sounds and the display shows `Site Locked`.
- 2 The LED turns off and the display shows the channel alias.

OR

Procedure:

Use the menu.

- 1  to access the menu.
- 2  or  to `Utilities` and press  to select.
- 3  or  to `Radio Settings` and press  to select.
- 4  or  to `Site Roaming` and press  to select.
- 5  or  to `Lock Site` and press  to select. A tone sounds and the display shows `Site Locked`.
- 6 The LED turns off and the radio returns to the Home screen. The display shows the channel alias.













Starting a Manual Site Search

Procedure:

Press the programmed **Manual Site Roam** button and proceed to Step 6.

OR

Follow the procedure below.

- 1  to access the menu.
- 2  or  to `Utilities` and press  to select.
- 3  or  to `Radio Settings` and press  to select.
- 4  or  to `Site Roaming` and press  to select.
- 5  or  to `Active Search` and press  to select.
- 6 A tone sounds and the display shows `Finding Site`. The LED blinks green.
- 7 If a new site is found, a tone sounds and the LED turns off. The display shows `Site <Alias> Found`.
OR
If there is no available site within range, a tone sounds and the LED turns off. The display shows `Out of Range`.
OR
If a new site is within range, but the radio is unable to connect to it, a tone sounds and the LED turns off. The display shows `Channel Busy`.
- 8 The radio returns to the Home screen.

■ Security



You can enable or disable any radio in the system. For example, you might want to disable a stolen radio, to prevent the thief from using it, and enable that radio, when it is recovered.

NOTE: Performing Radio Disable and Enable is limited to radios with these functions enabled. Check with your dealer or system administrator for more information.

Radio Disable

Procedure:















Use the programmed **Radio Disable** button.

- 1 Press the programmed **Radio Disable** button.
- 2  or  to the required alias or ID and press  to select.
- 3 The display shows Radio Disable: <Subscriber Alias or ID> and the LED lights up solid green.
- 4 Wait for acknowledgment.
- 5 If successful, a tone sounds and the display shows Radio Disable Successful.
OR
If not successful, a tone sounds and the display shows Radio Disable Failed.

OR

Procedure:

Use the menu.



- 1  to access the menu.
- 2  or  to Contacts and press  to select. The entries are alphabetically sorted.
- 3  or  to the required alias or ID and press  to select.
OR
 or  to Manual Dial and press  to select.
Key in the subscriber alias or ID and press .
- 4  or  to Radio Disable and press  to select. The LED blinks green.
- 5 The display shows Radio Disable: <Subscriber Alias or ID> and the LED lights up solid green.
- 6 Wait for acknowledgment.
- 7 If successful, a tone sounds and the display shows Radio Disable Successful.
OR
If not successful, a tone sounds and the display shows Radio Disable Failed.

Do not press  during the Radio Disable operation as you will not get an acknowledgement message.

Radio Enable

Procedure:





Use the programmed **Radio Enable** button.



- 1 Press the programmed **Radio Enable** button.
- 2  or  to the required alias or ID and press  to select.
- 3 The display shows Radio Enable: <Subscriber Alias or ID> and the LED lights up solid green.
- 4 Wait for acknowledgment.
- 5 If successful, a tone sounds and the display shows Radio Enable Successful.
OR
If not successful, a tone sounds and the display shows Radio Enable Failed.

OR





Procedure:



Use the menu.

- 1  to access the menu.
- 2  or  to `Contacts` and press  to select. The entries are alphabetically sorted.

- 3  or  to the required alias or ID and press  to select.

OR

 or  to `Manual Dial` and press  to select.
Key in the subscriber alias or ID and press .

- 4  or  to `Radio Enable` and press  to select. The LED blinks green.
- 5 The display shows Radio Enable: <Subscriber Alias or ID> and the LED lights up solid green.
- 6 Wait for acknowledgment.
- 7 If successful, a tone sounds and the display shows Radio Enable Successful.
OR
If not successful, a tone sounds and the display shows Radio Enable Failed.

Do not press  during the Radio Enable operation as you will not get an acknowledgement message.

■ Lone Worker

This feature prompts an emergency to be raised if there is no user activity, such as any radio button press or activation of the channel selector, for a predefined time.

Following no user activity for a programmed duration, the radio pre-warns the user via an audio indicator once the inactivity timer expires.

If there is still no acknowledgment by the user before the predefined reminder timer expires, the radio initiates an Emergency Alarm.

Only **one** of the following Emergency Alarms is assigned to this feature:

- Emergency Alarm
- Emergency Alarm with Call
- Emergency Alarm with Voice to Follow 

The radio remains in the emergency state allowing voice messages to proceed until action is taken. See **Emergency Operation** on page 50 on ways to exit Emergency.

NOTE: This feature is limited to radios with this function enabled. Check with your dealer or system administrator for more information.

■ Password Lock Features



If enabled, this feature allows you to access your radio via password upon powering up.

Accessing the Radio from Password

Procedure:

Power up the radio.

- 1 You hear a continuous tone. The first line of the display shows `Enter Password:`. The second line of the display shows a blinking cursor.

- 2 Enter a four-digit password. The second line of the display shows `****`. Press  to proceed. You hear a positive indicator tone for every digit pressed. Press  to remove the last * on the display. You hear a negative indicator tone, if you press  when the second line of the display is empty, or if you press more than four digits.

- 3 If the password is correct:
Your radio proceeds to power up. See **Powering Up the Radio** on page 5.
OR
If the password is incorrect:
The display shows `Wrong Password`. Repeat Steps 1 and 2. Password less than four digits is incorrect.
OR

After the third incorrect password, the display shows *Wrong Password* and then, shows *Radio Locked*. A tone sounds and the LED double blinks yellow.

*Your radio enters into locked state for 15 minutes, and responds to inputs from **On/Off/Volume Control Knob** and programmed **Backlight** button only.*

NOTE: The radio is unable to receive any call, including emergency calls, in locked state.

Unlocking the Radio from Locked State

Procedure:

Wait for 15 minutes. Repeat Steps 1 to 3 in **Accessing the Radio from Password** on page 74.

OR













Power up the radio, if you have powered down the radio during locked state:

- 1 A tone sounds and the LED double blinks yellow. The display shows *Radio Locked*.
 - 2 Wait for 15 minutes. Repeat Steps 1 to 3 in **Accessing the Radio from Password** on page 74.
-

Your radio restarts the 15 minutes timer for locked state when you power up.

Turning the Password Lock On or Off



Procedure:



- 1  to access the menu.
 - 2  or  to *Utilities* and press  to select.
 - 3  or  to *Radio Settings* and press  to select.
 - 4  or  to *Passwd Lock* and press  to select.
 - 5 The first line of the display shows *Current Password:*.
 - 6 Enter a four-digit password. The second line of the display shows ******. Press  to proceed.
 - 7 If the password is correct:
The first line of the display shows *Passwd Lock* and the second line of the display shows *Turn On*. Press  to enable password lock. The display shows *Password Lock On*.
OR
The first line of the display shows *Passwd Lock* and the second line of the display shows *Turn Off*. Press  to disable password lock. The display shows *Password Lock Off*.
OR
If the password is incorrect:
The display shows *Wrong Password* and automatically returns to the previous menu.
-



Changing the Password

Procedure:

- 1  to access the menu.



- 2  or  to Utilities and press  to select.

- 3  or  to Radio Settings and press  to select.

- 4  or  to Passwd Lock and press  to select.

- 5 The first line of the display shows Current Password:.

- 6 Enter a four-digit password. The second line of the display shows ****. Press  to proceed.

- 7 If the password is correct:
 or  to Change Pwd and press  to select.
OR
If the password is incorrect:
The display shows Wrong Password and automatically returns to the previous menu.

- 8 The first line of the display shows New Password:.

- 9 Enter a new four-digit password. The second line of the display shows ****. Press  to proceed.
You hear a negative indicator tone, if you press more than four digits.

- 10 The first line of the display shows Confirm Password:.

- 11 Reenter the new four-digit password. The second line of the display shows ****. Press  to proceed.
OR
If the new password is less than four digits:
The display shows Four Digitals Required. Repeat Steps 8 to 11.

- 12 If both of the new password inputs match:
The display shows Password Changed.
OR
If both of the new password inputs do not match:
The display shows Passwords Do Not Match.











- 13 The screen automatically returns to the previous menu.

■ Utilities

Locking and Unlocking the Keypad

You can lock your radio's keypad to avoid inadvertent key entry.















Procedure:

- 1  to access the menu.
 - 2  or  to Utilities and press  to select.
 - 3  or  to Radio Settings and press  to select.
 - 4  or  to Keypad Lock and press  to select.
 - 5 The display shows Keypad Locked and returns to the Home screen.
 - 6 To unlock the keypad, press  followed by *.
 - 7 The display shows Keypad Unlocked and returns to the Home screen.
-

Turning Keypad Tones On or Off

You can enable and disable keypad tones if needed.

Procedure:

- 1  to access the menu.
 - 2  or  to Utilities and press  to select.
 - 3  or  to Radio Settings and press  to select.
 - 4  or  to Tones/Alerts and press  to select.
 - 5  or  to Keypad Tones and press  to select.
 - 6 The display shows Turn On. Press  to enable keypad tones. The display shows Keypad Tone On.
OR
The display shows Turn Off. Press  to disable keypad tones. The display shows Keypad Tone Off.
-

Setting the Squelch Level

You can adjust your radio's squelch level to filter out unwanted calls with low signal strength or channels that have a higher than normal background noise.











Settings: *Normal* is the default. *Tight* filters out (unwanted) calls and/or background noise. However, calls from remote locations may also be filtered out.

Procedure:

Press the programmed **Squelch** button to toggle squelch level between normal and tight.

OR

Follow the procedure below.

- 1  to access the menu.
- 2  or  to *Utilities* and press  to select.
- 3  or  to *Radio Settings* and press  to select.
- 4  or  to *Squelch* and press  to select.
- 5 Choose either *Tight* or *Normal* and press  to select.
- 6 Screen returns to the previous menu.

Turning the Option Board Feature(s) On or Off

A channel can support up to 6 option board features. Refer to your dealer or system administrator for more information.

Procedure:

Press the programmed **Option Board Feature** button to toggle the feature on or off.

Turning the Voice Operating Transmission (VOX) Feature On or Off

This feature allows you to initiate a hands-free voice activated call on a programmed channel. The radio automatically transmits, for a programmed period, whenever the microphone on the VOX-capable accessory detects voice.

Pressing the **PTT** button during radio operation will disable VOX. To re-enable VOX, do **one** of the following:

- Turn the radio off and power it on again, **OR**
- Change the channel via the Channel Selector Knob, **OR**
- Follow the procedure below.

NOTE: Turning this feature on or off is limited to radios with this function enabled. Check with your dealer or system administrator for more information.



Procedure:



Press the programmed **VOX** button to toggle the feature on or off.



OR

Follow the procedure below.

- 1  to access the menu.

- 2  or  to Utilities and press  to select.

- 3  or  to Radio Settings and press  to select.

- 4  or  to VOX and press  to select.

- 5 The display shows VOX On. Press  to disable VOX. A tone sounds and the display shows VOX Off.

OR

The display shows VOX Off. Press  to enable VOX. A tone sounds and the display shows VOX On.

*If the Talk Permit Tone feature is enabled (see **Turning the Talk Permit Tone On or Off** on page 81), use a trigger word to initiate the call. Wait for the Talk Permit Tone to finish before speaking clearly into the microphone.*

 **Controlling the Display Backlight**

You can enable or disable the radio's display backlight as needed. The setting also affects the Menu Navigation Buttons and keypad backlighting accordingly.



Procedure:



Press the programmed **Backlight** button to toggle the backlight settings.



OR



Follow the procedure below.

- 1  to access the menu.

 - 2  or  to Utilities and press  to select.

 - 3  or  to Radio Settings and press  to select.

 - 4  or  to Backlight and press  to select.

 - 5 The display shows Auto On. Press  to enable the display backlight. The display shows Backlight Auto On.
- OR**
- The display shows Turn Off. Press  to disable the display backlight. The display shows Backlight Turn Off.

*The display backlight and keypad backlighting are automatically turned off if the LED indicator is disabled (see **Turning the LED Indicator On or Off** on page 81).*

Turning the Radio Tones/Alerts On or Off















You can enable and disable all radio tones and alerts (except for the incoming Emergency alert tone) if needed.

Procedure:

Press the programmed **All Tones/Alerts** button to toggle all tones on or off.

OR

Follow the procedure below.

- 1  to access the menu.
- 2  or  to *Utilities* and press  to select.
- 3  or  to *Radio Settings* and press  to select.
- 4  or  to *Tones/Alerts* and press  to select.
- 5  or  to *All Tones* and press  to select.
- 6 The display shows *Turn On*. Press  to enable all tones and alerts. The display shows *All Tones On*.

















OR

The display shows *Turn Off*. Press  to disable all tones and alerts. The display shows *All Tones Off*.

Setting the Tone Alert Volume Offset Level

You can adjust the Tone Alert Volume Offset level if needed. This feature adjusts the volume of the tones/alerts, allowing it to be higher or lower than the voice volume.















Procedure:

- 1  to access the menu.
 - 2  or  to *Utilities* and press  to select.
 - 3  or  to *Radio Settings* and press  to select.
 - 4  or  to *Tones/Alerts* and press  to select.
 - 5  or  to *Vol. Offset* and press  to select.
 - 6  or  to the required volume value. The radio sounds a feedback tone with each corresponding volume value.
 - 7 Press  to keep the required displayed volume value. The display shows *Volume Offset Selected*.
- OR**
Repeat Step 6 to select another volume value.
- OR**
 to exit without changing the current volume offset settings.

Turning the Talk Permit Tone On or Off

You can enable and disable the Talk Permit Tone if needed.











Procedure:



-  to access the menu.
-  or  to Utilities and press  to select.
-  or  to Radio Settings and press  to select.
-  or  to Tones/Alerts and press  to select.
-  or  to Talk Permit and press  to select.
- The display shows Turn On. Press  to enable the Talk Permit Tone. The display shows Talk Permit Tone On.
OR
The display shows Turn Off. Press  to disable the Talk Permit Tone. The display shows Talk Permit Tone Off.

Turning the LED Indicator On or Off

You can enable and disable the LED Indicator if needed.

Procedure:

-  to access the menu.
-  or  to Utilities and press  to select.
-  or  to Radio Settings and press  to select.
-  or  to LED Indicator and press  to select.













- The display shows Turn On. Press  to enable the LED Indicator. The display shows All LEDs On.
OR
The display shows Turn Off. Press  to disable the LED Indicator. The display shows All LEDs Off.

*The display backlight, buttons, and keypad backlighting are automatically turned off if the LED indicator is disabled (see **Controlling the Display Backlight** on page 79).*

Turning the Introduction Screen On or Off

You can enable and disable the Introduction Screen if needed.



Procedure:

-  to access the menu.
-  or  to Utilities and press  to select.
-  or  to Radio Settings and press  to select.
-  or  to Intro Screen and press  to select.
- The display shows Turn On. Press  to enable the Introduction Screen. The display shows Intro Screen On.
OR
The display shows Turn Off. Press  to disable the Introduction Screen. The display shows Intro Screen Off.

Accessing General Radio Information

Your radio contains information on the following:











- Battery
- Radio Alias and ID 
- Software Version
- Codeplug Version

NOTE: Press  at any time to return to the previous screen or long press  to return to the Home screen. The radio exits the current screen once the inactivity timer expires.

Accessing the Battery Information

Displays information on your radio battery.

Procedure:

- 1  to access the menu.
- 2  or  to Utilities and press  to select.
- 3  or  to Radio Info and press  to select.
- 4  or  to Battery Info and press  to select.



- 5 The display shows the battery information.

OR

For **IMPRES** batteries **ONLY:** The display reads Recondition Battery if the battery requires reconditioning in an IMPRES charger.

After the reconditioning process, the display then shows the battery information.

For IMPRES batteries ONLY:

Press  or  to access the *Remaining Capacity, Date of Initial Use, or Service Life option screen:*

- *Select Remaining Capacity to view battery capacity level, indicated by a horizontal bar and percentage reading.*
- *Select Date of Initial Use to view the date when battery is first used.*
- *Select Service Life to view the potential and current capacity of the battery.*

Checking the Radio Alias and ID











Displays the ID of your radio.

Procedure:

Press the programmed Radio Alias and ID button to check your radio alias and ID. You hear a positive indicator tone.

OR

Follow the procedure below.











- 1  to access the menu.
- 2  or  to Utilities and press  to select.
- 3  or  to Radio Info and press  to select.
- 4  or  to My Number and press  to select.
- 5 The first line of the display shows the radio alias. The second line of the display shows the radio ID

*You can also press the programmed **Radio Alias and ID** button to return to the previous screen.*

Checking the Firmware Version

Displays the firmware version on your radio.











Procedure:

- 1  to access the menu.
- 2  or  to Utilities and press  to select.
- 3  or  to Radio Info and press  to select.
- 4  or  to Firmware Ver. and press  to select.
- 5 The display shows the current firmware version.

Checking the Codeplug Version

Displays the codeplug version on your radio.

Procedure:

- 1  to access the menu.
- 2  or  to Utilities and press  to select.
- 3  or  to Radio Info and press  to select.
- 4  or  to CP Ver. and press  to select.
- 5 The display shows the current codeplug version.

Accessories

Your radio is compatible with the accessories listed in this chapter. Contact your dealer for details.

Antennas	page 84
Batteries	page 84
Carry Devices	page 85
Chargers	page 85
Earbuds and Earpieces	page 85
Headsets and Headset Accessories	page 85
Remote Speaker Microphones	page 85
Miscellaneous Accessories	page 85

Antennas

The diagram on the right shows the location of the color indicator for the following antennas. See the footnote at the end of the list for the colors.



- Combination 800/900/GPS, 806 – 941 MHz, Helical Antenna⁹ (For XPR 6580 IS Only) (PMAF4005_)

Color Code:

1 Red	3 Black	5 Blue	7 Brown	9 Purple
2 Green	4 Yellow	6 White	8 Orange	

Batteries

- IMPRES Li-Ion, 1750 mAh Submersible (IP67) Battery, Intrinsically Safe (For XPR 6580 IS Only) (NNTN7789_)*
- IMPRES Li-Ion, 1750 mAh Submersible (IP67) (NNTN8287_)**

* For use with radio PMUF1473AKNBA and PMUF1473AJNBD Only

** For use with radio PMUF1473BKNBA and PMUF1473BJNBD Only

■ Carry Devices

- ATEX CSA Belt Clip for 2.5-Inch Belt Width (For XPR 6580 IS Only) (PMLN5134_)
- Hard Leather Carry Case with 3-Inch Swivel Belt Loop for Display Radio (For XPR 6580 IS Only) (PMLN5606_)
- Soft Leather Carry Case with 3-Inch Swivel Belt Loop for Display Radio (For XPR 6580 IS Only) (PMLN5607_)
- 2.5-Inch Replacement Swivel Belt Loop (For XPR 6580 IS Only) (PMLN5610_)
- 3-Inch Replacement Swivel Belt Loop (For XPR 6580 IS Only) (PMLN5611_)

■ Chargers

- IMPRES Multi-Unit Charger (WPLN4212_)
- IMPRES Multi-Unit Charger with Display (WPLN4219_)
- IMPRES Single-Unit Charger (WPLN4232_)

■ Earbuds and Earpieces

- Receive-Only Earpiece (RLN4941_)**

** For use with radio PMUF1473BKNBA and PMUF1473BJNBD Only

■ Headsets and Headset Accessories

- Behind the Head Heavy Duty Headset (PMLN5275_)**

** For use with radio PMUF1473BKNBA and PMUF1473BJNBD Only

■ Remote Speaker Microphones

- IMPRES Remote Speaker Microphone, Noise-Canceling (PMMN4050_)**
- IMPRES ATEX CSA Remote Speaker Microphone (For XPR 6580 IS Only) (PMMN4067_)

** For use with radio PMUF1473BKNBA and PMUF1473BJNBD Only

■ Miscellaneous Accessories

- Universal Connector Dust Cover (For XPR 6580 IS Only) (PMLN5649_)

Batteries and Chargers Warranty

The Workmanship Warranty

The workmanship warranty guarantees against defects in workmanship under normal use and service.

All MOTOTRBO Batteries	Two (2) Years
IMPRES Chargers (Single-Unit and Multi-Unit, Non-Display)	Two (2) Years
IMPRES Chargers (Multi-Unit with Display)	One (1) Year

The Capacity Warranty

The capacity warranty guarantees 80% of the rated capacity for the warranty duration.

Nickel Metal-Hydride (NiMH) or Lithium-Ion (Li-Ion) Batteries	12 Months
IMPRES Batteries, When Used Exclusively with IMPRES Chargers	18 Months

Limited Warranty

MOTOROLA COMMUNICATION PRODUCTS

I. WHAT THIS WARRANTY COVERS AND FOR HOW LONG:

MOTOROLA SOLUTIONS, INC. ("MOTOROLA") warrants the MOTOROLA manufactured Communication Products listed below ("Product") against defects in material and workmanship under normal use and service for a period of time from the date of purchase as scheduled below:

XPR Series Digital Portable Radios	Two (2) Years
Product Accessories (Excluding Batteries and Chargers)	One (1) Year

MOTOROLA, at its option, will at no charge either repair the Product (with new or reconditioned parts), replace it (with a new or reconditioned Product), or refund the purchase price of the Product during the warranty period provided it is returned in accordance with the terms of this warranty. Replaced parts or boards are warranted for the balance of the original applicable warranty period. All replaced parts of Product shall become the property of MOTOROLA.

This express limited warranty is extended by MOTOROLA to the original end user purchaser only and is not assignable or transferable to any other party. This is the complete warranty for the Product manufactured by MOTOROLA. MOTOROLA assumes no

obligations or liability for additions or modifications to this warranty unless made in writing and signed by an officer of MOTOROLA.

Unless made in a separate agreement between MOTOROLA and the original end user purchaser, MOTOROLA does not warrant the installation, maintenance or service of the Product.

MOTOROLA cannot be responsible in any way for any ancillary equipment not furnished by MOTOROLA which is attached to or used in connection with the Product, or for operation of the Product with any ancillary equipment, and all such equipment is expressly excluded from this warranty. Because each system which may use the Product is unique, MOTOROLA disclaims liability for range, coverage, or operation of the system as a whole under this warranty.

II. GENERAL PROVISIONS:

This warranty sets forth the full extent of MOTOROLA'S responsibilities regarding the Product. Repair, replacement or refund of the purchase price, at MOTOROLA'S option, is the exclusive remedy. THIS WARRANTY IS GIVEN IN LIEU OF ALL OTHER EXPRESS WARRANTIES. IMPLIED WARRANTIES, INCLUDING WITHOUT LIMITATION, IMPLIED WARRANTIES OF MERCHANTABILITY AND FITNESS FOR A PARTICULAR PURPOSE, ARE LIMITED TO THE DURATION OF THIS LIMITED WARRANTY. IN NO EVENT SHALL MOTOROLA BE LIABLE FOR DAMAGES IN EXCESS OF THE PURCHASE PRICE OF THE PRODUCT, FOR ANY LOSS OF USE, LOSS OF TIME, INCONVENIENCE, COMMERCIAL LOSS, LOST PROFITS OR SAVINGS OR OTHER INCIDENTAL, SPECIAL OR CONSEQUENTIAL DAMAGES ARISING OUT OF THE USE OR

INABILITY TO USE SUCH PRODUCT, TO THE FULL EXTENT SUCH MAY BE DISCLAIMED BY LAW.

III. STATE LAW RIGHTS:

SOME STATES DO NOT ALLOW THE EXCLUSION OR LIMITATION OF INCIDENTAL OR CONSEQUENTIAL DAMAGES OR LIMITATION ON HOW LONG AN IMPLIED WARRANTY LASTS, SO THE ABOVE LIMITATION OR EXCLUSIONS MAY NOT APPLY.

This warranty gives specific legal rights, and there may be other rights which may vary from state to state.

IV. HOW TO GET WARRANTY SERVICE:

You must provide proof of purchase (bearing the date of purchase and Product item serial number) in order to receive warranty service and, also, deliver or send the Product item, transportation and insurance prepaid, to an authorized warranty service location. Warranty service will be provided by MOTOROLA through one of its authorized warranty service locations. If you first contact the company which sold you the Product (e.g., dealer or communication service provider), it can facilitate your obtaining warranty service. You can also call MOTOROLA at 1-800-927-2744 US/Canada.

V. WHAT THIS WARRANTY DOES NOT COVER:

- A) Defects or damage resulting from use of the Product in other than its normal and customary manner.
- B) Defects or damage from misuse, accident, water, or neglect.

- C) Defects or damage from improper testing, operation, maintenance, installation, alteration, modification, or adjustment.
- D) Breakage or damage to antennas unless caused directly by defects in material workmanship.
- E) A Product subjected to unauthorized Product modifications, disassembles or repairs (including, without limitation, the addition to the Product of non-MOTOROLA supplied equipment) which adversely affect performance of the Product or interfere with MOTOROLA's normal warranty inspection and testing of the Product to verify any warranty claim.
- F) Product which has had the serial number removed or made illegible.
- G) Rechargeable batteries if:
 - (1) any of the seals on the battery enclosure of cells are broken or show evidence of tampering.
 - (2) the damage or defect is caused by charging or using the battery in equipment or service other than the Product for which it is specified.
- H) Freight costs to the repair depot.
- I) A Product which, due to illegal or unauthorized alteration of the software/firmware in the Product, does not function in accordance with MOTOROLA's published specifications or the FCC certification labeling in effect for the Product at the time the Product was initially distributed from MOTOROLA.
- J) Scratches or other cosmetic damage to Product surfaces that does not affect the operation of the Product.
- K) Normal and customary wear and tear.

VI. PATENT AND SOFTWARE PROVISIONS:

MOTOROLA will defend, at its own expense, any suit brought against the end user purchaser to the extent that it is based on a claim that the Product or parts infringe a United States patent, and MOTOROLA will pay those costs and damages finally awarded against the end user purchaser in any such suit which are attributable to any such claim, but such defense and payments are conditioned on the following:

- A) that MOTOROLA will be notified promptly in writing by such purchaser of any notice of such claim;
- B) that MOTOROLA will have sole control of the defense of such suit and all negotiations for its settlement or compromise; and
- C) should the Product or parts become, or in MOTOROLA's opinion be likely to become, the subject of a claim of infringement of a United States patent, that such purchaser will permit MOTOROLA, at its option and expense, either to procure for such purchaser the right to continue using the Product or parts or to replace or modify the same so that it becomes non-infringing or to grant such purchaser a credit for the Product or parts as depreciated and accept its return. The depreciation will be an equal amount per year over the lifetime of the Product or parts as established by MOTOROLA.

MOTOROLA will have no liability with respect to any claim of patent infringement which is based upon the combination of the Product or parts furnished hereunder with software, apparatus or devices not furnished by MOTOROLA, nor will MOTOROLA have any liability for the use of ancillary equipment or software not furnished by MOTOROLA which is attached to or used in connection with the Product. The foregoing states the entire liability of MOTOROLA with respect to infringement of patents by the Product or any parts thereof.

Laws in the United States and other countries preserve for MOTOROLA certain exclusive rights for copyrighted MOTOROLA software such as the exclusive rights to reproduce in copies and distribute copies of such MOTOROLA software. MOTOROLA software may be used in only the Product in which the software was originally embodied and such software in such Product may not be replaced, copied, distributed, modified in any way, or used to produce any derivative thereof. No other use including, without limitation, alteration, modification, reproduction, distribution, or reverse engineering of such MOTOROLA software or exercise of rights in such MOTOROLA software is permitted. No license is granted by implication, estoppel or otherwise under MOTOROLA patent rights or copyrights.

VII. GOVERNING LAW:

This Warranty is governed by the laws of the State of Illinois, U.S.A.



Motorola Solutions, Inc.
1303 East Algonquin Road
Schaumburg, Illinois 60196 U.S.A.

MOTOROLA, MOTO, MOTOROLA SOLUTIONS and the Stylized M logo are trademarks or registered trademarks of Motorola Trademark Holdings, LLC and are used under license. All other trademarks are the property of their respective owners.
© 2011, 2012 Motorola Solutions, Inc. All rights reserved.
February 2012.

www.motorolasolutions.com/motrbo



68009431001-B