

APX TWO-WAY RADIOS

APX 8000H

Model 3.5

USER GUIDE

JULY 2018

© 2018 Motorola Solutions, Inc. All rights reserved



MN004478A01-AA

Contents

Declaration of Conformity.....	12	P25 Digital Vehicular Repeater System (DVRS).....	24
Important Safety Information.....	14	Conventional Talkgroup and Radio Scan Enhancements.....	24
Notice to Users (FCC and Industry Canada).....	15	What Your Dealer/System Administrator Can Tell You.....	25
Software Version.....	16	Preparing Your Radio for Use.....	26
Computer Software Copyrights.....	17	Charging the Battery.....	26
Documentation Copyrights.....	18	Attaching the Battery	26
Disclaimer.....	19	Attaching the Antenna.....	28
Getting Started.....	20	Removing and Attaching the Accessory Connector Cover.....	29
Notations Used in This Manual.....	20	Using the Carry Holder.....	30
Radio Care.....	20	Turning On the Radio	31
Cleaning Your Radio.....	22	Adjusting the Volume.....	33
Radio Service and Repair.....	23	Identifying Radio Controls.....	34
Additional Performance Enhancement.....	23	Radio Parts and Controls.....	34
ASTRO 25 Enhanced Data.....	23	Programmable Features.....	35
Dynamic System Resilience (DSR).....	24	Assignable Radio Functions.....	36
CrossTalk Prevention.....	24	Assignable Settings or Utility Functions..	39
Encrypted Integrated Data (EID).....	24	Accessing the Preprogrammed Functions.....	39
SecureNet.....	24	Menu Select Buttons.....	40

Home Button.....	40	Chapter 1: General Radio Operation.....	65
4-Way Navigation Button.....	40	Selecting a Zone.....	65
Data Feature Button.....	41	Selecting a Radio Channel.....	66
Keypad.....	41	Selecting a Channel by using Channel Search Button.....	67
Keypad Characters – Uppercase Mode..	41	Mode Select Feature.....	67
Keypad Characters – Lowercase Mode..	42	Saving a Zone and a Channel to a Softkey.....	68
Keypad Characters – Numeric Mode.....	44	Saving a Zone and a Channel to a Button.....	68
Keypad Characters – Hexadecimal Mode.....	45	Receiving and Responding to a Radio Call.....	69
Push-To-Talk (PTT) Button.....	47	Receiving and Responding to a Talkgroup Call.....	69
Identifying Status Indicators.....	48	Receiving and Responding to a Private Call (Trunking Only).....	69
Status Icons.....	48	Receiving and Responding to a Telephone Call (Trunking Only).....	70
Text Messaging Service (TMS) Indicators.....	53	Methods to Make a Radio Call.....	71
TMS Status Icons.....	53	Making a Talkgroup Call	71
TMS Menu Options.....	54	Making a Private Call (Trunking Only)....	72
Call Type Icons.....	55	Making an Enhanced Private Call (Trunking Only).....	73
LED Indicator.....	55		
Intelligent Lighting Indicators.....	56		
Alert Tones	58		
Phone Call Displays and Alerts.....	62		
Display Color Change On Channel.....	63		
HAZLOC Battery Type Detection.....	64		

Making a Telephone Call (Trunking Only).....	74	Dynamic Zone Programming (DZP).....	81
Switching Between Repeater or Direct Operation Button.....	74	Entering the Dynamic Zone to Select a Dynamic Channel.....	82
Monitor Feature.....	75	Saving a Channel in the Dynamic Zone from List Selection.....	82
Monitoring a Channel.....	75	Saving a Channel in the Dynamic Zone from Channel Name.....	83
Monitoring Conventional Mode.....	76	Deleting a Channel in the Dynamic Zone.....	84
Chapter 2: Advanced Features.....	77	Zone to Zone Cloning.....	84
Advanced Call Features.....	77	Contacts.....	86
Selective Call (ASTRO Conventional Only).....	77	Making a Private Call from Contacts.....	86
Receiving a Selective Call.....	77	Adding a New Contact Entry.....	87
Making a Selective Call.....	77	Deleting a Contact Entry.....	88
Talkgroup Call Feature (Conventional Operation Only).....	78	Adding a Contact to a Call List.....	89
Selecting a Talkgroup.....	78	Removing a Contact from a Call List.....	89
Sending a Status Call.....	79	Methods of Contact Editing in a Call List.....	90
Responding to the Dynamic Regrouping Feature (Trunking Only).....	80	Editing an Entry Alias.....	90
Requesting a Reprogram (Trunking Only).....	80	Editing as Entry ID.....	90
Classification of Regrouped Radios.....	81	Editing a Call Type.....	91

Viewing Details of a Contact.....	91	Sending An Emergency Call With Hot Mic (Trunking Only).....	101
Scan Lists.....	92	Sending an Emergency Alarm with Emergency Call.....	102
Intelligent Priority Scan.....	92	Sending An Emergency Alarm and Call with Hot Mic.....	103
Viewing a Scan List.....	92	Sending a Silent Emergency Alarm.....	104
Editing the Scan List.....	93	Change of Channels during Emergency.....	104
Changing the Scan List Status.....	94	Emergency Keep-Alive Feature.....	104
Viewing and Changing the Priority Status.....	94	Emergency Find Me.....	105
Scan.....	95	Sending and Receiving Emergency Find Me Beacon.....	105
Turning Scan On or Off.....	95	Fireground.....	106
Making a Dynamic Priority Change (Conventional Scan Only).....	96	Entering Fireground Zone Channel (Conventional).....	107
Deleting a Nuisance Channel.....	96	Sending Evacuation Tone.....	108
Restoring a Nuisance Channel.....	96	Responding to Evacuation Indicator.....	108
Call Alert Paging.....	97	Tactical Public Safety (TPS) (Conventional Only).....	109
Receiving a Call Alert Page.....	97	Using TPS Normal Transmission.....	109
Sending a Call Alert Page.....	97	Using TPS Emergency Transmission...	109
Emergency Operation.....	99	Man Down.....	110
Sending an Emergency Alarm.....	100		
Sending an Emergency Call (Trunking Only).....	101		

Pre-Alert Timer.....	111	Appending a Priority Status to a Text Message.....	121
Post-Alert Timer.....	111	Removing a Priority Status from a Text Message.....	122
Radio Alerts When Man Down Feature is Triggered.....	112	Appending a Request Reply to a Text Message.....	122
Triggering Emergency.....	112	Removing a Request Reply from a Text Message.....	123
Radio Alerts When Man Down Enhanced is Triggered.....	112	Appending a Priority Status and a Reply Request to a Text Message.....	123
Exiting Man Down Feature.....	113	Removing a Priority Status and a Reply Request from a Text Message.....	123
Re-Initiating Man Down.....	113	Receiving a Text Message.....	124
Testing the Man Down Feature.....	114	Viewing a Text Message from the Inbox.....	124
Automatic Registration Service (ARS).....	114	Replying to a Received Text Message.....	125
Selecting or Changing the ARS Mode..	114	Accessing the Drafts Folder.....	126
User Login Feature.....	115	Sent Text Messages.....	127
Logging In as a User.....	115	Deleting a Text Message.....	128
Logging Out.....	117	Deleting All Text Messages.....	128
Text Messaging Service (TMS).....	117		
Accessing the Messaging Features.....	118		
Composing and Sending a New Text Message.....	118		
Sending a Quick Text Message.....	120		
Priority Status and Request Reply of a New Text Message.....	121		

ASTRO 25 Advanced Messaging Solution.....	129	MDC Over-the-Air Rekeying	
System Setup for ASTRO Advanced		Page.....	140
Messaging Solution.....	130	Infinite UKEK Retention.....	140
Two-Factor Authentication.....	130	Hear Clear.....	140
Logging in using the Two-Factor		Security.....	141
Authentication.....	130	Radio Lock.....	141
Logging out of Two-Factor		Unlocking Your Radio.....	141
Authentication.....	132	Changing Your Password.....	142
Sending a Query.....	133	Changing Your Tactical Inhibit	
Receiving a Query.....	134	Password.....	142
Secure Operations.....	135	Enabling or Disabling the Radio	
Selecting Secure Transmissions.....	135	Lock Feature (Secure Radios	
Selecting Clear Transmissions	135	Only).....	143
Managing Encryption.....	136	Radio Stun and Kill.....	144
Loading an Encryption Key.....	136	Radio Stun.....	144
Multikey Feature.....	136	Using Radio Stun.....	144
Selecting an Encryption Key.....	137	Radio Kill.....	145
Selecting a Keypad.....	137	Using Remote Kill to Kill Another	
Erasing the Selected Encryption		Radio.....	145
Keys.....	138	Using Direct Kill to Kill Your	
Requesting an Over-the-Air		Own Radio.....	146
Rekey (ASTRO Conventional		Radio Inhibit.....	146
Only).....	139		

Global Positioning System/Global Navigation Satellite System.....	146	Entering Mission Critical Geofence.....	157
GPS Operation.....	147	Exiting Mission Critical Geofence.....	158
GPS Performance Enhancement.....	147	Trunking System Controls.....	158
The Outdoor Location Feature (Using GPS).....	148	Operating in Failsafe System.....	158
Military Grid Reference System (MGRS) Coordinates.....	149	Out-of-Range Radio.....	159
Accessing the Outdoor Location Feature.....	149	Site Trunking Feature.....	159
Saving a Waypoint.....	150	Locking and Unlocking a Site.....	159
Viewing a Saved Waypoint.....	151	Site Display and Search Button.....	160
Editing the Alias of a Waypoint.....	151	Viewing the Current Site.....	160
Editing the Coordinates of a Waypoint.....	152	Changing the Current Site.....	160
Deleting a Single Saved Waypoint.....	153	Mission Critical Wireless - Bluetooth®	160
Deleting All Saved Waypoints.....	154	Turning On Bluetooth	161
Measuring the Distance and Bearing from a Saved Waypoint.....	154	Turning Off the Bluetooth.....	162
Location Feature in Emergency Mode..	155	Re-Pair Timer.....	162
Geofence (ASTRO 25 Trunking System).....	155	Bluetooth Drop Timer.....	163
Entering the Geofence Area.....	156	Pairing with Low Frequency-Motorola Proximity Pairing (LF-MPP) Feature.....	164
Mission Critical Geofence.....	157	Radio Indications of Lost Bluetooth Connection.....	165
		Standard Pairing Feature.....	166
		Searching and Pairing the Bluetooth Device.....	166

Turning On Bluetooth Visibility... 167	Disabling Holster Sensor
Receiving Pairing Request from	Temporarily..... 177
other Devices..... 168	Disabling Holster Sensor
Turning Off Bluetooth Visibility... 168	Permanently..... 177
PIN Authentication in Pairing..... 169	Over-the-Air Programming (POP 25, ASTRO
Pairing the Authentication PIN	25, and ASTRO Conventional and Wi-Fi) 177
when Receiving a Pairing	Responding to the Notification of
Request..... 169	Upgrade..... 178
Pairing the Authentication PIN	Voice Announcement 179
with the Generated Numeric PIN	Site Selectable Alerts (ASTRO 25)..... 180
..... 170	Sending SSA Notification to Single Site
Turning On the Bluetooth Audio..... 171 180
Turning Off the Bluetooth Audio..... 172	Sending SSA Notification to Single Site
Adjusting the Volume of the Radio from	by Manual Entry..... 181
Bluetooth Audio Device..... 173	Sending SSA Notification to All Sites.... 182
Viewing and Clearing the Bluetooth	Sending SSA Notification to All
Device Information..... 173	Available Sites..... 183
Clearing All Bluetooth Devices	Stopping SSA Notification of a Single
Information..... 174	Site..... 184
Editing the Bluetooth Friendly Name.... 175	Stopping SSA Notification of a Single
Pairing with LEX Handheld..... 175	Site by Manual Entry..... 184
Holster Sensor..... 176	Stopping SSA Notification of All Sites... 185

Stopping SSA Notification of All Available Sites.....	186	Turning the Controls and Keypad Buttons Tones On or Off.....	195
Wi-Fi.....	187	Turning Voice Mute On or Off.....	195
Turning Wi-Fi On or Off.....	187	Using the Time-Out Timer.....	196
Selecting WiFi Network.....	187	Time and Date Setup.....	196
Checking the Wi-Fi Configuration and Status of the Radio.....	188	Editing the Time and Date.....	197
Utilities.....	189	Using Conventional Squelch Operation Features.....	198
Viewing Recent Calls.....	189	Analog Options.....	198
Using the Flip Display.....	190	Digital Options.....	198
Selecting a Basic Zone Bank.....	190	Using the PL Defeat Feature.....	198
Selecting the Power Level.....	190	Digital PTT ID Support.....	199
Selecting a Radio Profile.....	191	Smart PTT Feature (Conventional Only).....	199
Selecting an Enhanced Zone Bank.....	192	Transmit Inhibit.....	200
Enabling and Disabling the Radio Alias	192	Enabling Transmit Inhibition.....	200
Controlling the Display Backlight.....	193	Disabling Transmit Inhibition.....	201
Setting Up the Radio Display and Visual Indicators to Suit Night Vision Goggles.....	193	Instant Recall.....	201
Locking and Unlocking the Keypad and Controls.....	194	Saving and Playback Calls.....	201
		IMPRES Battery Annunciator.....	203
		Accessing the Battery Info screen.....	204

General Radio Information.....	204	Non-Commercial Call Channel.....	212
Accessing the Radio Information		Operating Frequency Requirements.....	213
.....	204	Declaration of Compliance for the Use of	
Viewing the IP Information.....	205	Distress and Safety Frequencies.....	215
Viewing the Control		Technical Parameters for Interfacing External	
Assignments.....	206	Data Sources.....	215
Editing the Soft ID.....	206	Chapter 6: Glossary.....	216
Front Panel Programming.....	207	Chapter 7: Limited Warranty.....	223
Entering the Front Panel		MOTOROLA SOLUTIONS	
Programming Mode.....	207	COMMUNICATION PRODUCTS.....	223
Editing FPP Mode Parameters..	208	I. WHAT THIS WARRANTY COVERS AND	
Chapter 3: Helpful Tips.....	209	FOR HOW LONG:.....	223
Battery Care.....	209	II. GENERAL PROVISIONS:.....	224
Battery Charge Status.....	209	III. STATE LAW RIGHTS:.....	225
LED and Sounds.....	209	IV. HOW TO GET WARRANTY SERVICE:.....	225
Fuel Gauge Icons.....	209	V. WHAT THIS WARRANTY DOES NOT	
Battery Recycling and Disposal.....	210	COVER:.....	225
Chapter 4: Accessories.....	211	VI. PATENT AND SOFTWARE	
Chapter 5: Maritime Radio Use in the VHF		PROVISIONS:.....	226
Frequency Range.....	212	VII. GOVERNING LAW:.....	227
Special Channel Assignments.....	212	VIII. For Australia Only.....	227
Emergency Channel.....	212		

Declaration of Conformity

This declaration is applicable to your radio only if your radio is labeled with the FCC logo shown below.

Declaration of Conformity

Per FCC CFR 47 Part 2 Section 2.1077(a)



Responsible Party

Name: Motorola Solutions, Inc.

Address: 1303 East Algonquin Road, Schaumburg, IL 60196-1078, U.S.A.

Phone Number: 1-800-927-2744

Hereby declares that the product:

Model Name: **APX 8000H**

conforms to the following regulations:

FCC Part 15, subpart B, section 15.107(a), 15.107(d), and section 15.109(a)

Class B Digital Device

As a personal computer peripheral, this device complies with Part 15 of the FCC Rules. This device complies with Industry Canada license-exempt RSS standard(s). Operation is subject to the following two conditions:

- 1 This device may not cause harmful interference, and
- 2 This device must accept any interference received, including interference that may cause undesired operation.



NOTICE:

This equipment has been tested and found to comply with the limits for a Class B digital device, pursuant to part 15 of the FCC Rules and Industry Canada license-exempt RSS standard. These limits are designed to provide reasonable protection against harmful interference in a residential installation. This equipment generates, uses and can radiate radio frequency energy and, if not installed and used in accordance with the instructions, may cause harmful interference to radio communications. However, there is no guarantee that interference will not occur in a particular installation.

If this equipment does cause harmful interference to radio or television reception, which can be determined by turning the equipment off and on, the user is encouraged to try to correct the interference by one or more of the following measures:

- Reorient or relocate the receiving antenna.
- Increase the separation between the equipment and receiver.
- Connect the equipment into an outlet on a circuit different from that to which the receiver is connected.
- Consult the dealer or an experienced radio or TV technician for help.

Important Safety Information

RF Energy Exposure and Product Safety Guide for Portable Two-Way Radios

ATTENTION!

This radio is restricted to Occupational use only. Before using the radio, read the RF Energy Exposure and Product Safety Guide for Portable Two-Way Radios which contains important operating instructions for safe usage and RF energy awareness and control for Compliance with applicable standards and Regulations.

For a list of Motorola Solutions-approved antennas, batteries, and other accessories, visit the following website:

<http://www.motorolasolutions.com>

Under Industry Canada regulations, this radio transmitter may only operate using an antenna of a type and maximum (or lesser) gain approved for the transmitter by Industry Canada. To reduce potential radio interference to other users, the antenna type and its gain should be so chosen that the equivalent isotropically radiated power (e.i.r.p.) is not more than that necessary for successful communication.

This radio transmitter has been approved by Industry Canada to operate with Motorola Solutions-approved antenna with the maximum permissible gain and required antenna impedance for each antenna type indicated. Antenna types not included in this list, having a gain greater than the maximum gain indicated for that type, are strictly prohibited for use with this device.

Notice to Users (FCC and Industry Canada)

This device complies with Part 15 of the FCC rules and Industry Canada's license-exempt RSS's per the following conditions:

- This device may not cause harmful interference.
- This device must accept any interference received, including interference that may cause undesired operation.
- Changes or modifications made to this device, not expressly approved by Motorola Solutions, could void the authority of the user to operate this equipment.

Software Version

All the features described in the following sections are supported by the software version **R18.00.00** or later.

See [Accessing the Radio Information on page 204](#) to determine the software version of your radio.

Check with your dealer or system administrator for more details of all the features supported.

Computer Software Copyrights

The Motorola Solutions products described in this manual may include copyrighted Motorola Solutions computer programs stored in semiconductor memories or other media. Laws in the United States and other countries preserve for Motorola Solutions certain exclusive rights for copyrighted computer programs including, but not limited to, the exclusive right to copy or reproduce in any form the copyrighted computer program. Accordingly, any copyrighted Motorola Solutions computer programs contained in the Motorola Solutions products described in this manual may not be copied, reproduced, modified, reverse-engineered, or distributed in any manner without the express written permission of Motorola Solutions. Furthermore, the purchase of Motorola Solutions products shall not be deemed to grant either directly or by implication, estoppel, or otherwise, any license under the copyrights, patents or patent applications of Motorola Solutions, except for the normal non-exclusive license to use that arises by operation of law in the sale of a product.

Documentation Copyrights

No duplication or distribution of this document or any portion thereof shall take place without the express written permission of Motorola Solutions. No part of this manual may be reproduced, distributed, or transmitted in any form or by any means, electronic or mechanical, for any purpose without the express written permission of Motorola Solutions.

Disclaimer

The information in this document is carefully examined, and is believed to be entirely reliable. However, no responsibility is assumed for inaccuracies. Furthermore, Motorola Solutions reserves the right to make changes to any products herein to improve readability, function, or design. Motorola Solutions does not assume any liability arising out of the applications or use of any product or circuit described herein; nor does it cover any license under its patent rights, nor the rights of others.

Getting Started

How to Use This Guide

This User Guide covers the basic operation of the APX Portables .

However, your dealer or system administrator may have customized your radio for your specific needs. Check with your dealer or system administrator for more information.

Notations Used in This Manual

Throughout the text in this publication, you will notice the use of **Warning**, **Caution**, and **Notice**. These notations are used to emphasize that safety hazards exist, and the care that must be taken or observed.



WARNING:

An operational procedure, practice, or condition and so on, which may result in injury or death if not carefully observed.



CAUTION:



An operational procedure, practice, or condition and so on, which may result in damage to the equipment if not carefully observed.



NOTICE:

An operational procedure, practice, or condition and so on, which is essential to emphasize.

The following special notations identify certain items.

Example	Description
Home button or 	Buttons and keys are shown in bold print or as an icon.
Phon	Menu entries are shown similar to the way they appear on the display of the radio.
	This means “Press the right side of the 4-Way Navigation Button”.

Radio Care

Proper radio usage and care assures efficient operation and long life for the product.

The following are recommendations and warnings when using the radio

**CAUTION:**

- Your radio has a vent port that allows for pressure equalization in the radio. Never poke this vent **A** with any objects, such as fingernails, needles, tweezers, or screwdrivers. This could create leak paths into the radio and the radio's submergibility will be lost.

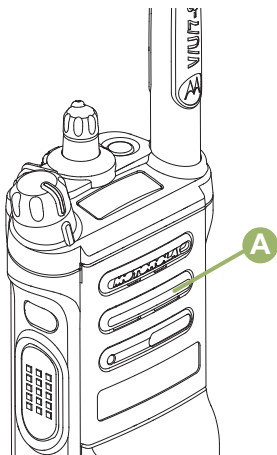

- Your radio is designed to be submerged to a maximum depth of 2 meters, with a maximum submersion time of 4 hours. Exceeding either

maximum limit may result in damage to the radio.

- Elastomer seals used in portable radios can age with time and environmental exposure. Therefore, Motorola Solutions recommends that radios be checked annually as a preventive measure in order to assure the waterseal integrity of the radio. Motorola Solutions details the disassembly, test, and reassembly procedures along with necessary test equipment in the radio service manual.
- If the radio battery contact recess is exposed to water without the battery attached, dry and clean the radio battery contacts before attaching a battery to the radio. Turn the radio over with the battery contact recess facing down and shake the radio so any trapped water can escape. The battery contacts must be dry before attaching a battery or a short circuit of the contacts could occur.
- If the radio side accessory connector contacts are exposed to water without an accessory or accessory connector cover attached, clean and dry this area to prevent foreign material build up

or contact corrosion. These can prevent reliable accessory interconnect to the radio.

- Accessory connector cover must be attached to the radio side accessory connector if an accessory is not attached to the radio.
- If the radio is submerged or exposed to a high force water spray, such as from a hose, remove the side accessory connector or accessory connector cover immediately and check to make sure no water was forced into the accessory connector/radio interface. Rinse and dry the area and re-attach the accessory or accessory connector cover if leakage occurs.
- If the radio is exposed to a corrosive environment, such as salt water or corrosive gases or liquids, rinse and clean the radio immediately to prevent damage to radio materials, especially plated surfaces. Refer to [Cleaning Your Radio on page 22](#) for detailed instructions. Remove the battery and the antenna before cleaning if exposed to corrosive environments.
- If the radio has been submerged in water, shake the radio well so that any water that may be trapped inside the speaker grille and microphone

port can be removed. Otherwise, the water will decrease the audio quality of the radio.

- Do **not** disassemble the radio. This could damage radio seals and result in leak paths into the radio. Any radio maintenance should be performed only by a qualified radio technician.
- Underwriter Laboratory (UL) certified radios should only be opened and serviced by UL approved service centers. Opening or repairing at unauthorized locations will invalidate the radio's hazardous location rating.
- Do **not** pound, drop, or throw the radio unnecessarily.
- When charging the radio using a wall mounted charger, the radio must be turned off. Otherwise, the Man Down Alert and Emergency may be accidentally triggered.

Cleaning Your Radio



CAUTION:

Do not use solvents or disinfectants to clean your radio as these chemicals may permanently damage the radio housing, seals, and adhesives.

To clean the external surfaces of your radio, follow the procedure described next.

- 1 Combine one teaspoon of mild dishwashing detergent to one gallon of water (0.5% solution).
- 2 Apply the solution sparingly with a stiff, non-metallic, shortbristled brush, making sure that excess detergent does not get entrapped near the connectors, controls, or crevices. Rinse and then dry the radio thoroughly with a soft, lint-free cloth.
- 3 Clean battery contacts with a lint-free cloth to remove dirt or grease.

Radio Service and Repair

Proper repair and maintenance procedures will assure efficient operation and long life for this product. A Motorola Solutions maintenance agreement will provide expert service to keep this and all other communication equipment in perfect operating condition.

A nationwide service organization is provided by Motorola Solutions to support maintenance services. Through its maintenance and installation program, Motorola Solutions

makes available the finest service to those desiring reliable, continuous communications on a contract basis.

For a contract service agreement, please contact your nearest Motorola Solutions service or sales representative, or an authorized Motorola Solutions dealer.

Additional Performance Enhancement

The following performance enhancements are some of the latest creations designed to enhance the security, quality, and efficiency of the radios.

ASTRO 25 Enhanced Data

ASTRO 25 Enhanced Data is optimized to handle different message sizes and variable update rates from different applications of the radio. Add Enhanced Data to the Integrated Data system with a software installation to improve data channel efficiency and enable denser network traffic.

Dynamic System Resilience (DSR)

DSR ensures the radio system is seamlessly switched to a backup master site dynamically in case of system failure. DSR also provides additional indication such as failure detection, fault recovery, and redundancy within the system to address to the user in need. Mechanisms related to the Integrated Voice and Data (IV&D) or data centric are all supported by DSR.

CrossTalk Prevention

This feature prevents crosstalk scenarios from happening, especially when a wideband antenna is used. This feature allows the adjustment of the internal SSI clock rate of the radio. This subsequently reduces the possibility of radio frequency interfering spurs and prevents the issues of crosstalk.

Encrypted Integrated Data (EID)

EID provides security encryption and authentication of IV&D data bearer service communication between the radio and the Customer Enterprise Network.

SecureNet

SecureNet allows user to perform secured communications on an Analog or Motorola Data Communication (MDC) channel. The MDC Over-the-Air Rekeying (OTAR) feature will allow users to perform OTAR activities on an MDC channel.

P25 Digital Vehicular Repeater System (DVRS)

Motorola Solutions offers an MSI Certified APX compatible, 3rd Party, P25 Digital Vehicular Repeater System (DVRS) that provides low cost portable radio coverage in areas where only mobile radio coverage is available and portable radio coverage is either intermittent or non-existent.

Conventional Talkgroup and Radio Scan Enhancements

A few enhancements have been made to the Conventional Talkgroup at the system. These enhancements improve the Scan feature operation significantly when multiple agencies are using a single conventional radio frequency channel. These enhancements allow users to use Selective Squelch to operate on only the subset of talkgroups that are

relevant to the users rather than all talkgroups on the channel. These Scan improvements have been made to eliminate the audio holes that were present and to turn on the busy LED when activity is present on the channel. Mixed Vote Scan and Standard Conventional Scan configurations are supported. Priority Operation is also supported.

Up to 30 different talkgroups can be supported using conventional channels. A maximum of four talkgroups can be supported when Vote Scan channels are being used.

Smart **PTT** is supported with this enhancement as Smart **PTT** prevents users from transmitting while other users are on the channel.

**NOTICE:**

User Selectable Talkgroups are not compatible with this Conventional Talkgroup Enhancement.

What Your Dealer/System Administrator Can Tell You

Check with your dealer or system administrator for the correct radio settings, if the radio is to be operated in extreme temperatures (less than -30 °C or more than +60 °C).

You can consult your dealer or system administrator about the following:

- Is your radio programmed with any preset conventional channels?
- Which buttons have been programmed to access other features?
- What optional accessories may suit your needs?

**NOTICE:**

Specifications may vary for different radio models. Check with your dealer or system administrator for more information.

Preparing Your Radio for Use

This section provides simple instructions to prepare your radio for use.

Charging the Battery

**WARNING:**

To avoid a possible explosion:

- Do **not** replace the battery in any area labeled **hazardous atmosphere**.
- Do **not** discard batteries in a fire.

The Motorola Solutions-approved battery shipped with your radio is uncharged. Prior to using a new battery, charge it for a minimum of 16 hours to ensure optimum capacity and performance. For a list of Motorola Solutions-authorized batteries and chargers available for use with your radio, see [Accessories on page 211](#).

**NOTICE:**

When charging a battery attached to a radio, the radio must be turned off.

To charge the battery, place the battery (with or without the radio) in a Motorola Solutions-approved charger.

The LED on the charger indicates the charging progress; see the *Charger User Guide*.

Attaching the Battery

If your radio is preprogrammed with volatile-key retention, the encryption keys are retained for approximately 30 seconds after battery removal. Check with your dealer or system administrator for more information.

You can view the status of the battery if the radio is using an IMPRES battery. See [IMPRES Battery Annunciator on page 203](#) for more information.

**NOTICE:**

User is notified if radio detects non-Motorola Solutions battery upon powering up, charging, or removing from the charger. This feature is applicable for IMPRES and Non-IMPRES battery. When the radio is attached with the non-Motorola Solutions battery, a tone sounds, display shows Unknown Battery temporarily, and battery indicator is not shown in the radio display. Battery menu screen displays Unknown Battery permanently and IMPRES battery information is not shown on the radio display.

- 1 Slide the battery into the radio frame until the side latches click into place.

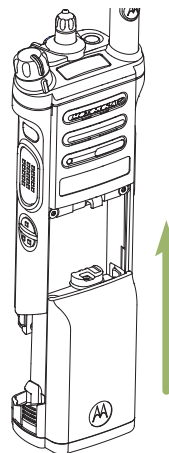

- 2 To remove the battery, turn the radio off. Squeeze the release latches (A) at the bottom of the battery until the battery releases from the radio and remove the battery from the radio.

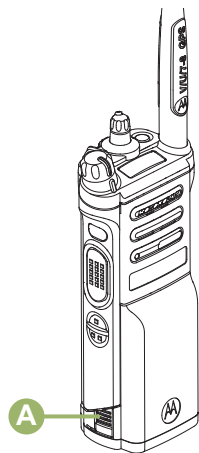

Attaching the Antenna

Ensure the radio is turned off before attaching the antenna.

- 1 Set the antenna in the receptacle.
- 2 Turn the antenna clockwise to attach to the radio.

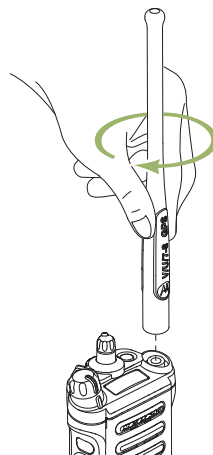

-
- 3 To remove the antenna, turn the antenna counterclockwise.



NOTICE:

When removing the antenna, ensure that the radio is turned off.

Removing and Attaching the Accessory Connector Cover

The accessory connector is on the antenna side of the radio. It is used to connect accessories to the radio.



NOTICE:

To prevent damage to the connector, shield it with the connector cover when not in use.

- 1 To remove the accessory connector cover, rotate the thumbscrew **B** counterclockwise until it disengages from the radio.



NOTICE:

If the thumbscrew is too tight, use an Allen wrench at **C** to loosen it first.

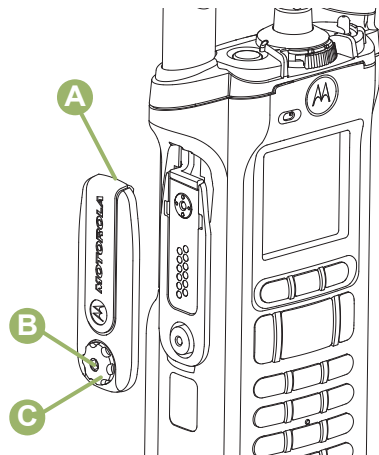

- 2 Rotate and lift the connector cover to disengage it from the radio.
- 3 To attach the accessory connector cover, insert the hooked end **A** of the cover into the slot above the connector.
- 4 Press the top of the cover downward to seat it in the slot.

- 5 Once in place, tighten by rotating the thumbscrew **B** clockwise by hand.
-

Using the Carry Holder

- 1 Position the radio within the carry holder with the main speaker facing outward.

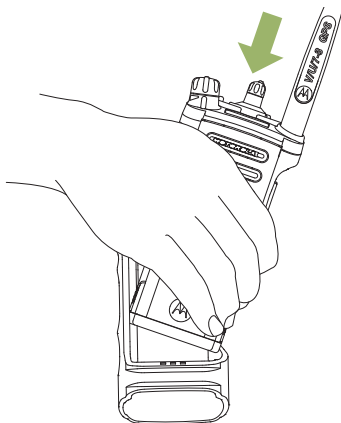

- 2 Slide the radio down into the carry holder until it clicks in place.
-

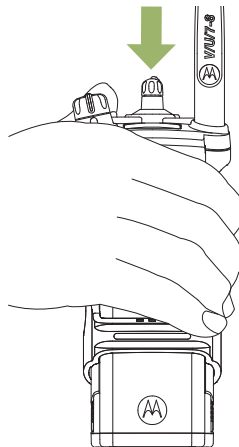

- 3 To remove the radio from the carry holder, place the tip of your fingers on the ledge of the carry holder.

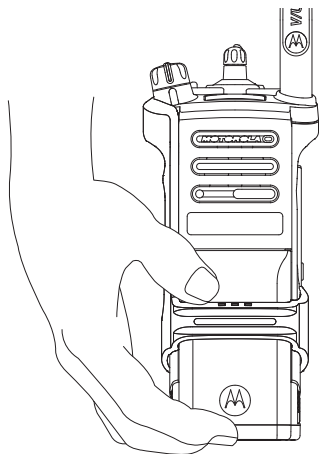

-
- 4 Push at the bottom of the radio until the radio is released from it.

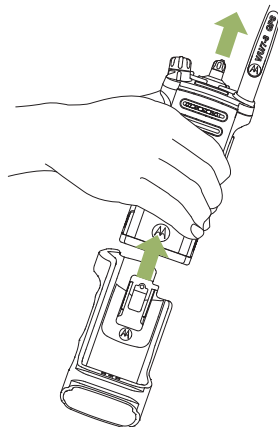

Turning On the Radio

- 1 Rotate the **On/Off/Volume Control Knob** clockwise until you hear a click.

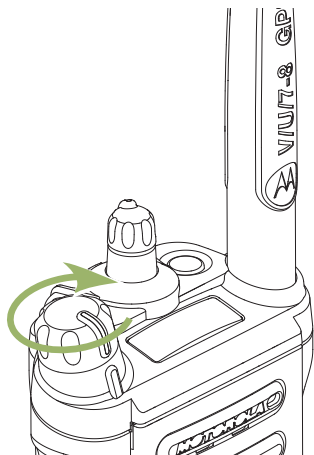

- If the power-up test is successful, you see a splash screen on the radio display, followed by the Home screen.
- If the power-up test is unsuccessful, you see Error XX/YY (XX/YY is an alphanumeric code).



NOTICE:

If the radio fails to power-up after repeating a few times, record the Error XX/YY code and contact your dealer.

- 2 To turn off the radio, rotate the **On/Off/Volume Control Knob** counterclockwise until you hear a click.

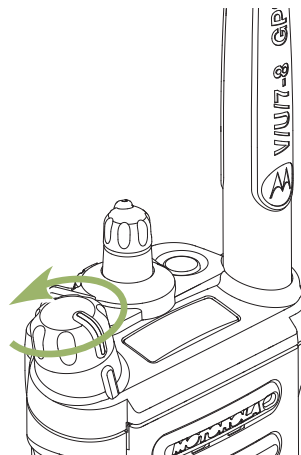

Adjusting the Volume

Ensure the radio is powered on and the main speaker is pointed towards you for increased loudness and intelligibility, especially in areas with loud background noises.

- 1 To increase the volume, rotate the **On/Off/Volume Control Knob** **A** clockwise.

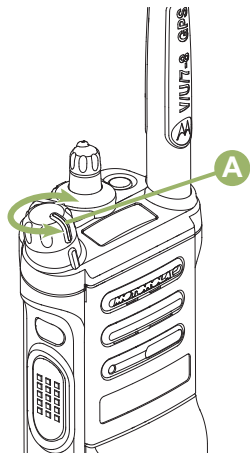

- 2 To decrease the volume, rotate this knob counterclockwise.
-

Identifying Radio Controls

This chapter explains the buttons and functions to control the radio.

Radio Parts and Controls

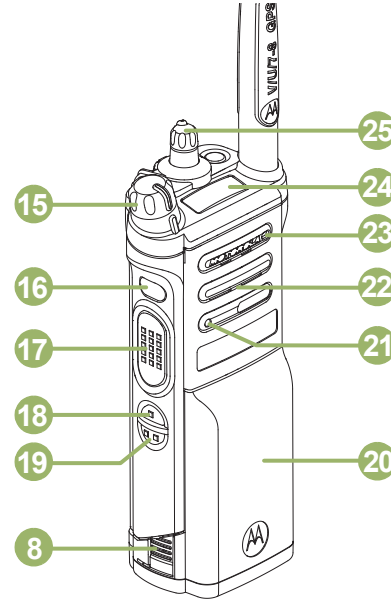
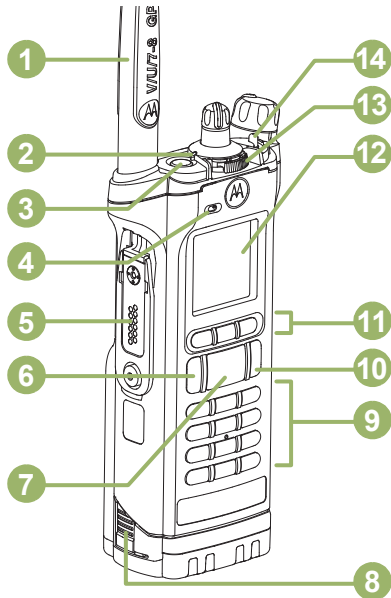

1	Antenna
2	LED
3	Top (Orange) Button ¹
4	Microphone

5	Accessory Connector
6	Home Button
7	4–Way Navigation Button
8	Battery Latch
9	Keypad
10	Data Feature Button
11	Menu Select Buttons
12	Main Display
13	2–Position Concentric Switch ¹
14	3–Position A/B/C Switch ¹
15	On/Off/Volume Control Knob
16	Top Side (Select) Button ¹
17	Push-to-Talk (PTT) Button
18	Side Button 1 ¹
19	Side Button 2 ¹
20	Battery
21	Bluetooth Pairing Location Indicator

22	Main Speaker
23	Microphone
24	Top Display
25	16–Position Select Knob ¹

Programmable Features

Any reference in this manual to controls that are preprogrammed means that a qualified radio technician must use the radio programming software to assign a feature to a control.

Your dealer can program the programmable buttons as shortcuts to radio functions or preset channels/groups depending on the duration of a button press:

Press

Pressing and releasing rapidly.

Long press

Pressing and holding for the preprogrammed duration (between 0.25 and 3.75 seconds).

Hold down

Keeping the button pressed.

¹ These radio controls/buttons are programmable.

Assignable Radio Functions

Bluetooth On/Off

Allows you to turn on/off the Bluetooth.

Bluetooth Configuration

Allows you to access to the Bluetooth menu.

Bluetooth Audio Reroute

Allows you to toggle the audio route between radio speaker or Remote Speaker Microphone and Bluetooth headset.

Bluetooth Headset PTT

Keys up the Bluetooth Headset microphone.

Bluetooth Data Devices

Pairs with the data devices for data transfer.

Bluetooth Clear All Pairing

Allows you to clear all pairing information for Bluetooth. This is accessed by a long press of the Bluetooth On/Off Button.

Bluetooth Inquiry On/Off

Enables Bluetooth Search feature.

Bluetooth Discoverable On/Off

Enables Bluetooth visibility. This is accessed by a long press of the Bluetooth Inquiry On/Off Button.

Call Alert

Allows the radio to function like a pager, or to verify if a radio is active on the system.

Call Response

Allows you to answer a private call.

Channel

Selects a channel.

Contacts

Selects the Contacts menu.

Dynamic ID (Conventional Only)

Allows you to edit the ASTRO Individual ID and/or MDC Primary ID of the radio.

Dynamic Priority (Conventional Only)

Allows any channel in a Scan List (except for the Priority-One channel) to temporarily replace the Priority-Two channel.

Emergency

Depending on the programming, initiates or cancels an emergency alarm or call.

Internet Protocol Address

Display the Internet Protocol (IP) address, device name, and status of the radio.

Location

Determines the current location (latitude, longitude, time and date), and also the distance and bearing to another location or turns the GPS functionality on or off for all locations.

Man Down Clear

Clears the Man Down mode alarm that is triggered when your radio achieves or passes a tilt angle threshold or a combination of the angle threshold and a motion sensitivity level.

Message

Enters the current message list.

Mode Select

Long-press programs a button with the current zone and channel of the radio; once programmed, the short-press of that button changes the radio zone channel to the programmed zone and channel.

Monitor (Conventional Only)

Monitors a selected channel for all radio traffic until function is disabled.

Multiple Private Line (Conventional Only)

Selects the Multiple Private Line lists.

Nuisance Delete

Temporarily removes an unwanted channel, except for priority channels or the designated transmit channel from the scan list.

One Touch 1–4

Launches a specific feature with one single button-press. You can setup as many as four separately programmed buttons for four different features.

Phone

Allows you to make and receive calls similar to standard phone calls.

Private Call (Trunking Only)

Allows a call from one individual radio to another.

Private Line Defeat (Conventional Only)

Overrides any coded squelch (DPL or PL) that is preprogrammed to a channel.

Query

Launches a list of predefined short text messages only after successfully logged in the two-Factor Authentication.

Radio Profiles

Allows easy access to a set of preprogrammed visual and audio settings of the radio.

Recent Calls

Allows easy access to the list of calls recently received or made.

Rekey Request

Notifies the dispatcher that a new encryption key is needed.

Repeater Access Button (RAB) (Conventional Only)

Allows user to manually send a repeater access codeword.

Reprogram Request (Trunking Only)

Notifies the dispatcher that a new dynamic regrouping assignment is needed.

Request-To-Talk (Conventional Only)

Notifies the dispatcher you want to send a voice call.

Scan

Toggles scan on or off.

Scan List Programming

Selects the scan list for editing (by long press on the Scan button).

Secure Transmission Select (Conventional and Trunking)

Toggles the Secure Transmission On or Off when the Secure/Clear Strapping fields is set to `Select` for the

current channel and when the radio is model/option capable.

Selective Call (Conventional Only)

Calls an assigned radio.

Site Display/Search (Trunking Only)

Displays the current site ID and RSSI value; performs site search for Automatic Multiple Site Select (AMSS) or SmartZone operation.

Site Lock/Unlock (Trunking Only)

Locks onto a specific site.

Status (Astro 25 Trunking Only)

Sends data calls to the dispatcher about a predefined status.

Talkaround/Direct (Conventional Only)

Toggles between using a repeater and communicating directly with another radio.

Talkgroup (Conventional Only)

Allows a call from an individual radio to a group of radios.

Text Messaging Service (TMS)

Selects the text messaging menu.

TMS Quick Text

Selects a predefined message.

User

Automatically registers the users to the server.

Zone Select

Allows selection from a list of zones.

Basic Zone Bank

Provides access from up to six zones by toggling between two banks of three zones, one group of three (A, B, and C) to a second group of three zones (D, E, and F).

Enhanced Zone Bank

Provides access from up to 75 zones by toggling between 25 banks (A, B, ... X or Y) of three zones.

Wi-Fi®

Toggles Wi-Fi on or off.

Assignable Settings or Utility Functions

Keypad/Controls Lock

Locks or unlocks the keypad, programmable buttons, switches or rotary knobs.

Light/Flip

Press the button to toggle the display backlight on or off; press and hold the button to reverse the content of the top display.

TX Power Level

Toggles transmit power level between high and low.

Voice Announcement

Audibly indicates the current feature mode, Zone or Channel the user has just assigned.

Voice Mute

Toggles voice mute on or off.

Volume Set Tone

Sets the volume set tone.

Accessing the Preprogrammed Functions

You can access various radio functions through one of the following methods.

- A short or long press of the relevant programmable buttons.
- Use the **Menu Select** Button.

- Use the **Menu Select** and **Navigation** buttons.

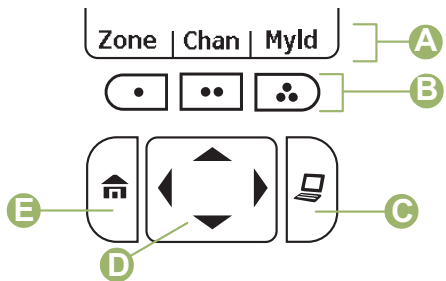

A	Softkeys
B	Menu Select Buttons
C	Data Feature Button
D	4-Way Navigation Button
E	Home Button

Menu Select Buttons





NOTICE:

Check with your dealer or system administrator for the list of features activated in your radio.

Use the **Menu Select** button to access the menu entry of your radio feature. Your radio may be preprogrammed differently from the following example, but the steps for selecting a channel may appear as shown below:

Press the **Menu Select** button directly below Chan .

Home Button

Pressing the  button returns you to the Home (default) screen. In most cases, this is the current mode. For selected radio features, the  button is also used to save user-edited radio settings or information before returning you to the Home screen.



NOTICE:

Some features do not require you to press  to go to the Home screen. Refer to the individual feature sections in this manual for further details on saving user-edited radio settings or information.

4-Way Navigation Button

Use the **4-Way Navigation Button** to scroll up, down, left, or right with one of the following methods.

- Press and release one of the buttons to scroll from one entry to the next one.
- Press and hold one of the buttons to have the radio toggles through the list automatically (release the button to stop).

Data Feature Button







Use **Data Feature** button to access data-related features, such as the Text Messaging Service (TMS) feature screen.

Keypad Characters – Uppercase Mode

Keypad

You can use the 3 x 4 alphanumeric keypad to access your radio features. The keypad functions in a manner similar to a standard telephone keypad when entering numeric digits. When the keypad is used to edit a list, each key can generate different characters of the alphabet. The following tables show the number of times a key needs to be pressed to generate the required character.

Key	Number of Times Key is Pressed																				
	1	2	3	4	5	6	7	8	9	1	1	1	1	1	1	1	1	1	1	2	2
										0	1	2	3	4	5	6	7	8	9	0	1
	1	.	,	?	!	;	@	_	-	*	#	&	\$	/	+	=	\	"	'	()
	A	B	C																		
	D	E	F																		
	G	H	I																		
	J	K	L																		

Key	Number of Times Key is Pressed																					
	1	2	3	4	5	6	7	8	9	10	11	12	13	14	15	16	17	18	19	20	21	22
	M	N	O																			
	P	Q	R	S																		
	T	U	V																			
	W	X	Y	Z																		
	Toggle between mixed case mode, uppercase mode and lowercase mode.																					
	Space																					
	Toggle between numeric and letter mode.																					

Keypad Characters – Lowercase Mode

Key	Number of Times Key is Pressed																					
	1	2	3	4	5	6	7	8	9	10	11	12	13	14	15	16	17	18	19	20	21	22
	1	.	,	?	!	;	@	_	-	*	#	&	\$	/	+	=	\	"	'	()	

Key	Number of Times Key is Pressed																					
	1	2	3	4	5	6	7	8	9	10	11	12	13	14	15	16	17	18	19	20	21	22
	a	b	c																			
	d	e	f																			
	g	h	i																			
	j	k	l																			
	m	n	o																			
	p	q	r	s																		
	t	u	v																			
	w	x	y	z																		
	Toggle between mixed case mode, uppercase mode and lowercase mode.																					
	Space																					
	Toggle between numeric and letter mode.																					

Keypad Characters – Numeric Mode





Key	Number of Times Key is Pressed																			
	1	2	3	4	5	6	7	8	9	10	11	12	13	14	15	16	17	18	19	20
	1	.	,	?	!	;	@	-	*	#	&	\$	/	+	=	\	"	'	()
	2																			
	3																			
	4																			
	5																			
	6																			
	7																			
	8																			
	9																			
	0																			
	Space																			

Key	Number of Times Key is Pressed																					
	1	2	3	4	5	6	7	8	9	1	1	1	1	1	1	1	1	1	1	2	2	
# DEL										0	1	2	3	4	5	6	7	8	9	0	1	

Toggle between numeric and letter mode.

Keypad Characters – Hexadecimal Mode

Key	Number of Times Key is Pressed																					
	1	2	3	4	5	6	7	8	9	1	1	1	1	1	1	1	1	1	1	2	2	
1 .,?	1									0	1	2	3	4	5	6	7	8	9	0	1	
2 ABC	2	A	B	C																		
3 DEF	3	D	E	F																		
4 GHI	4																					
5 JKL	5																					
6 MNO	6																					
7 PQRS	7																					

Key	Number of Times Key is Pressed																					
	1	2	3	4	5	6	7	8	9	1	1	1	1	1	1	1	1	1	1	2	2	
										0	1	2	3	4	5	6	7	8	9	0	1	
 8																						
 9																						
 0																						
 *	Not applicable																					
 #	Not applicable																					

Push-To-Talk (PTT) Button

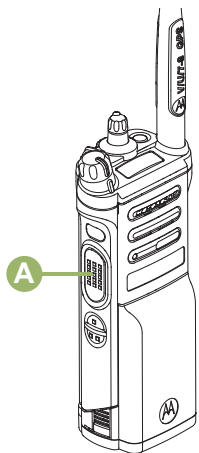

- While a call is not in progress, the **PTT** button is used to make a new call. See [Methods to Make a Radio Call on page 71](#) for more information.

The **PTT** button **A** on the side of the radio serves two basic purposes:

- While a call is in progress, the **PTT** button allows the radio to transmit to other radios in the call. Press and hold down **PTT** button to talk. Release the **PTT** button to listen. The microphone is activated when the **PTT** button is pressed.

Identifying Status Indicators

This chapter explains the status indicators used in the radio.

Status Icons

The 130 x 130 pixel front liquid crystal display (LCD) of your radio shows radio status, text entries, and menu entries. The top two display rows contain color icons that indicate radio operating conditions.

Selected icons are also shown on the first row of the 112 x 32 pixel top monochrome display screen of your radio.

The following icons are for the front display screen unless indicated otherwise.

	<p>Receiving Radio is receiving a call or data.</p>
<p>Top Display:</p>	



Transmitting

Radio is transmitting a call or data.

Top Display:



Call Received

Radio has received an Individual Call.



Battery

For IMPRES battery operation only – the icon shown indicates the charge remaining in the battery.

Top Display:



For all battery operation – the icon blinks when the battery is low or wrong battery is detected.



Received Signal Strength Indicator (RSSI)

The number of bars displayed represents the received signal strength for the current site (trunking only) The more stripes in the icon, the stronger the signal.

Top Display:





Roaming

The radio has roamed to and is currently registered to a foreign system.

Top Display:



Direct

On

Radio is currently configured for direct radio-to-radio communication (during conventional operation only).

Top Display:



Off

Radio is connected with other radios through a repeater.



Monitor (Carrier Squelch)

Selected channel is being monitored (during conventional operation only).

Top Display:



In-Call User Alert

On

The feature is enabled. Voice muting of the affiliated trunking talkgroup or selected conventional channel is activated.

Off

The feature is disabled. Voice muting of the affiliated trunking talkgroup or selected conventional channel is deactivated.



Power Level

Top Display:



Radio is set at Low power.



Radio is set at High power.



Scan







Radio is scanning a scan list.

Top Display:



Priority Channel Scan

Top Display:

<p>Z.</p>	<p>Blinking dot Radio detects activity on channel designated as Priority-One.</p> <p>Steady dot Radio detects activity on channel designated as Priority-Two.</p>	<p>B Radio is in Zone 2.</p> <p>C Radio is in Zone 3.</p>
<p>Top Display: </p>	<p>View/Program Mode Radio is in the view or program mode.</p> <p>On steady View mode</p> <p>Blinking Program mode</p>	<p>Top Display: </p> <p>Basic Zone Bank 2</p> <p>D Radio is in Zone 4.</p> <p>E Radio is in Zone 5.</p> <p>F Radio is in Zone 6.</p>
<p></p> <p>Top Display: </p>	<p>Vote Scan Enabled The vote scan feature is enabled.</p>	<p>Top Display: </p> <p>Enhanced Zone Bank</p> <p>A Contains Zone 1, Zone 2, and Zone 3,</p> <p>B Contains Zone 4, Zone 5, and Zone 6,</p> <p>C Contains Zone 7, Zone 8, and Zone 9,</p> <p>until </p> <p>or</p>
<p>Top Display: </p>	<p>Basic Zone Bank 1</p> <p>A Radio is in Zone 1.</p>	



X

Contains Zone 70, Zone 71, and Zone 72,

Y

Contains Zone 73, Zone 74, and Zone 75.



Secure Operation

Top Display:

On

Secure operation.

Off

Clear operation.

Blinking

Receiving an encrypted voice call.



AES

AES Secure Operation

On

AES secure operation.

Off

Clear operation.

Blinking

Receiving an encrypted voice call.



GPS Signal

On

Feature is enabled and signal is available.

Off

Feature is disabled.

Blinking

Feature is enabled, but no signal is available.



User Login Indicator (IP Packet Data)

On

User is currently associated with the radio.

Off

User is currently not associated with the radio.







Blinking







Device registration or user registration with the server failed due to an invalid username or pin.

Inverted

User successfully login to the secured IP Packet Data.



	Data Activity Data activity is present.
	Hexadecimal Indicates that the text entry is currently in hexadecimal mode.
	Numeric Indicates that the text entry is currently in numeric mode.
	Start Case Indicates that the first character of the text entry is capitalized.
	Mixed Case Indicates that the text entry is currently in normal text mode.
	Uppercase Indicates that the text entry is currently in uppercase mode.
	Lowercase Indicates that the text entry is currently in lowercase mode.

	Lowercase Predictive Indicates that the text entry is currently in lowercase and with predicted words shown at the bottom of the screen.
	Mixedcase Predictive Indicates that the text entry is currently in mixed case and with predicted words shown at the bottom of the screen.
	Uppercase Predictive Indicates that the text entry is currently in uppercase and with predicted words shown at the bottom of the screen.
	Bluetooth On Bluetooth is on and ready for Bluetooth connection.
Top Display: 	
	Bluetooth Connected Bluetooth is currently connected to the external Bluetooth device.
Top Display: 	



The radio Wi-Fi® network is connected. The number of bars displayed represents the signal strength of the Wi-Fi signal.

Text Messaging Service (TMS) Indicators

Status icons and menu options shown here help you to work more efficiently with TMS feature. See [Text Messaging Service \(TMS\) on page 117](#) for more information.

TMS Status Icons

The following icons appear on the radio display when you send and receive text messages.



Inbox Full

The Inbox is full.



Message Sent

The text message is sent successfully.



Message Unsent

The text message cannot be sent.



Unread Message

- User receives a new message.
- The selected text message in the Inbox has not been read.



Read Message

The selected text message in the Inbox has been read.



Normal Message

User is composing a message with normal priority and without a request for a reply.



Message Index

Indicates the index of the current message the user is viewing.

Example: If the user is looking at the third message out of a total of six messages in the

Inbox folder, the icon is displayed as the icon on the left column.



Priority Status

- The “Priority” feature is toggled on before the message is sent.
- Messages in the Inbox folder are flagged with “Priority”.



Request Reply

- The “Request Reply” feature is toggled on before the message is sent.
- Messages in the Inbox folder are flagged with “Request Reply”.



Priority Status and Request Reply

- User is composing a message with a priority status and a request for a reply.
- Messages in the Inbox folder are flagged with “Priority” and “Request Reply”.







TMS Menu Options



The following menu options appear on the radio display when you send and receive text messages.

Menu Option	Description/Function
Back	Brings you back to the previous screen.
Clr	Deletes all messages.
Del	Deletes a message or text.
Edit	Brings you to the edit screen.
Exit	Exits to the Home screen.
No	Returns to the previous screen.
Optn	Brings you to the Options main screen.
Rply	Replies to a message.
Sel	Selects the highlighted command.
Send	Sends the message.
Yes	Updates or saves a command.

Call Type Icons

The following icons appear on the radio main display, when you make or receive a call, or view selected call lists, to indicate the different call types associated with an alias or ID.

	Radio number.
	Radio number added to a Call List.
	Mobile number.
	Mobile number added to a Call List.
	Landline phone number.
	Landline phone number added to a Call List.
	Incoming call or data.

	Outgoing call or data.
	Incoming emergency call.

LED Indicator

The LED indicator **A** shows the operational status of your radio.

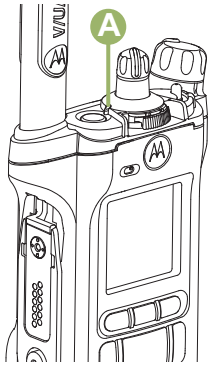

Solid red
Radio is transmitting.

Blinking red

Radio is transmitting at low battery condition or wrong battery is detected.

Double blinking red

Radio is in Emergency Mode.

Rapidly blinking red

Radio has failed the self test upon powering up or encountered a fatal error.

Solid yellow (Conventional Only)

Channel is busy.

Blinking yellow

Radio is receiving a secured transmission.

Solid green

Radio is powering up, or is on a non-priority channel while in the Scan List Programming mode.

Intelligent Lighting Indicators

This feature temporarily changes the backlight of the top display screen, and adds a color bar to the main display screen to help signal that a radio event has occurred

Blinking green

Radio is receiving an individual or telephone call, or is on a Priority-Two channel while in the Scan List Programming mode.

Rapidly blinking green

Radio is on a Priority-One channel while in the Scan List Programming mode.



NOTICE:

No LED indication when the radio receives a clear (non-secured) transmission in trunking Mode. LED indication can be preprogrammed by qualified technician to be permanently disabled. Consult your dealer for further details if you want to disable it.

**NOTICE:**

This feature must be preprogrammed by a qualified radio technician.

Backlight and Bar Color	Notification	When
Orange	Emergency Alerts	The radio initiates an emergency alarm or call.
		The radio receives an emergency alarm or call.
		The radio initiates the Man Down Post-Alert timer.
		The radio initiates Fireground Evacuation alarm.
Red	Critical Alerts	The radio battery is low.
		The radio is out of range.
		The radio enters Failsoft mode.
		The radio is unable to establish a full connection with the system.
		The radio is unable to authenticate or register with the system.
		The radio lost GPS signal or GPS function fails.
		The radio detects mismatch between the radio and the battery.
Green	Call Alerts	The radio receives a private call.
		The radio receives a phone call.
		The radio receives a call alert.

Backlight and Bar Color	Notification	When
		The radio receives a selective call.
		The radio enters Geofence.

Alert Tones

Your radio uses alert tones to inform you of the condition of your radio. The following table lists these tones and when they occur.

You Hear	Tone Name	Heard
Short, Low-Pitched Tone	Radio Self Test Fail	When radio fails its power-up self test.
	Reject	When an unauthorized request is made.
	Time-Out Timer Warning	Four seconds before time out.
	No ACK Received	When radio fails to receive an acknowledgment.
	Individual Call Warning Tone	When radio is in an individual call for greater than six seconds without any activity.
	Man Down Entry	When radio initiates Man Down mode.
Long, Low-Pitched Tone	Time-Out Timer Timed Out	After time out.
	Talk Prohibit/PTT Inhibit	(When PTT button is pressed) transmissions are not allowed.

You Hear	Tone Name	Heard
	Lack of Voice PTT Time out	When the radio ends your call after it detected there is lack of voice for 60 seconds after the PTT is pressed and hold. Your radio ends the call to enable your radio to receive calls from other radio users. The duration of this timer can be preprogrammed by a qualified radio technician.
	Out of Range	(When PTT button is pressed) the radio is out of range of the system.
	Invalid Mode	When radio is on an unpreprogrammed channel.
A Group of Low-Pitched Tones	Busy	When system is busy.
Short, Medium-Pitched Tone	Valid Key-Press	When a correct key is pressed.
	Radio Self Test Pass	When radio passes its power-up self test.
	Clear Voice	At beginning of a non-coded communication.
	Priority Channel Received	When activity on a priority channel is received.
	Emergency Alarm/Call Entry	When entering the emergency state.
	Central Echo	When central controller has received a request from a radio.



You Hear	Tone Name	Heard
Long, Medium-Pitched Tone	Volume Set	When volume is changed on a quiet channel.
	Emergency Exit	When exiting the emergency state.
A Group of Medium-Pitched Tones	Failsoft	When the trunking system fails.
	Automatic Call Back	When voice channel is available from previous request.
	Keyfail	When encryption key has been lost.
	Console Acknowledge	When status, emergency alarm, or reprogram request ACK is received.
	Received Individual Call	When Call Alert or Private Call is received.
	Call Alert Sent	When Call Alert is received by the target radio.
	Site Trunking	When a SmartZone trunking system fails.
Two Short, Medium-Pitched Tones	Over-the-Air Programming request	When the radio receives an over-the-air programming request.
Short, High-Pitched Tone (Chirp)	Low-Battery Chirp	When battery is below preset threshold value.
Two High-Pitched Tones	GPS Fails	When the GPS fails or loses signal.

You Hear	Tone Name	Heard
Ringling	Fast Ringing	When system is searching for target of Private Call.
	Enhanced Call Sent	When waiting for target of Private Call to answer the call.
	Phone Call Received	When a land-to-mobile phone call is received.
Gurgle	Dynamic Regrouping	(When PTT button is pressed) a dynamic ID has been received.
	Talk Permit	(When PTT button is pressed) is verifying with the system for accepting its transmissions.
Unique, Low-Pitched Chirp	New Message	When a new message is received.
Unique, High-Pitched Chirp	Priority Status	When a priority message is received.
Incremental-Pitched Tone	Bluetooth Paired	When Bluetooth accessory is paired with the radio.
	Bluetooth Connected	When Bluetooth accessory is connected to the radio.
Decremental-Pitched Tone	Bluetooth Unpaired	When Bluetooth accessory is unpaired from the radio.
	Bluetooth Disconnected	When Bluetooth accessory is disconnected from the radio.
A Group of Very High-Pitched Tones	Man Down Continuous Tone	When radio is in Man Down mode and prepares to transmit Emergency Alarm when the timer of this alarm ends.
	Critical Man Down Continuous Tone	When radio is in Man Down Enhanced mode and prepares to transmit Emergency Alarm when the timer of this alarm ends.

You Hear	Tone Name	Heard
Unique Low-High Tone	Enhanced Zone Bank Up	When EZB Up button is pressed to scroll the Enhance Zone Bank up.
Unique High-Low Tone	Enhanced Zone Bank Down	When EZB Down button is pressed to scroll the Enhance Zone Bank down.

Phone Call Displays and Alerts

The following phone call displays and alerts appears on the radio display when you make and receive Phone calls. The radio also uses alert tones to indicate the current status.

You Hear	You See	When	Notes
A Long Tone	No phone	You press the PTT button and the phone system is not available.	Press  to hang up. The radio returns to the Home screen.
	Phone busy	The phone system is busy.	Press  to exit the phone mode and try your call later.
A Busy Tone	Phone busy	When a channel is not available.	The radio automatically connects when a channel opens.
-	No acknowl- edge	The call is not acknowl- edged.	Press  to hang up. The radio returns to the Home screen.

You Hear	You See	When	Notes
A High- Pitch- ed Tone	–	When you release the PTT button.	The radio indicates to the landline party that the caller may begin talking.

**NOTICE:**

You have the option of sending additional digits (overdial), such as an extension number, credit card, or PIN numbers to the phone system. If the radio is preprogrammed for live overdial, every digit entered after the call is connected, is sent to the phone system.

If the radio is preprogrammed for buffered overdial, the digits pressed are entered into memory and then sent when the **PTT** button is pressed. Press the **PTT** button to send either digits or voice, but not both at the same time.

Display Color Change On Channel

This feature provides visual channel identification where users are able to have a quick visual recognition of being on a particular channel.

Your radio must be preprogrammed to allow you to use this feature.

When changing channels, the radio backlight on top display and accessories (DRSM or keypad Mic) changes to the preprogrammed color.

The radio backlight on top display changes to white and if connected to accessories, the DRSM backlight changes to white and the keypad mic backlight changes to green for the following scenarios:

- When changing to or powering up on an invalid channels such as unprogrammed channels, receiver frequency error channel and blank channels
- The radio is in radio stun or radio lock mode

For hard key zeroize, key loading, and scan list programming, the backlight follows the home channel backlight color.

HAZLOC Battery Type Detection

This feature alerts the user when there is a HAZLOC certification mismatch between the radio and the battery. This feature supports IMPRES batteries only.

During power up, if there is a mismatch, the following scenarios occurs:

- The radio repetitively displays `Wrong Battery` with red intelligent backlight
- The radio Voice Announcement announces the preprogrammed `Wrong Battery`.
- The Battery icon blinks continuously
- A repetitive tone sounds
- LED blinks RED continuously



NOTICE:

The radio alerts the user when NNTN8921 and NNTN8930 batteries are attached to the radio. These batteries are not supported by the radio. The radio requires a HAZLOC certified and compatible battery by default. The radio certification type cannot be configured as "None" in Customer Programming Software (CPS).

The radio does not display any indication when the radio is connected to the charger or when the radio and battery is UL certified.

The radio alerts the user when the battery is not UL certified with the radio. Refer to the radio UL Manual for a list of battery which is UL certified with the radio.

Check with your dealer or system administrator for more information.

General Radio Operation

This chapter explains the general radio operations in your radio.

Selecting a Zone

Your radio must be preprogrammed for you to use this feature.

A zone is a group of channels.



NOTICE:

Any reference to **Zone Select** Switch refers to Zone Select using the Menu.

Do one of the following to select a radio channel. You can use these options interchangeably depending on your preference and the programmed functions.



- Select a zone using the preprogrammed **Zone (3-Position A/B/C)** switch:



- a. Move the preprogrammed **Zone (3-Position A/B/C)** switch to the position of the required zone.

If the zone number entered is unprogrammed, the display shows `Invalid entry`. Repeat this step.

- b. Press the **PTT** button to transmit on the displayed zone channel.

- Select a zone using the radio menu `Zone`:

- a.  or  to `Zone` and press the **Menu Select** button directly below `Zone`.



- b.  or  to the required zone, or use the keypad to enter the zone number.

If the zone number entered is unprogrammed, the display shows `Invalid entry`. Repeat this step.

- c. Press the **Menu Select** button directly below `Set` to confirm the displayed zone.

- d. Press the **PTT** button to transmit on the displayed zone channel.

- Select a zone using the radio menu `ZnUp` or `ZnDn`:

- a.  or  to `ZnUp` or `ZnDn`.

- b. Press and hold the **Menu Select** button directly below ZnUp or ZnDn until the required zone appears.

Positions of ZnUp and ZnDn on the display may differ each time you release the **Menu Select** button. Read carefully before you press.

- c. Press the **PTT** button to transmit on the displayed zone channel.

Selecting a Radio Channel

A channel is a group of radio characteristics, such as transmit/receive frequency pairs. Do one of the following to select a radio channel. You can use the options interchangeably depending on your preference and the programmed functions.

- Select a channel using the preprogrammed **16–Position Select Knob** to the desired channel.
 - a. Rotate the preprogrammed **16–Position Select Knob** to the desired channel.
 - b. Press the **PTT** button to transmit on the displayed zone channel.
- Select a channel using the radio menu Chan :

- a. ◀ or ▶ to Chan.

- b. Press the **Menu Select** button directly below Chan .

- c. ▲ or ▼ to the required channel or use the keypad to enter the channel number.

If the channel number entered is unprogrammed, the display shows Invalid entry. Repeat this step.

- d. Press the **Menu Select** button directly below Sel to confirm the selected channel.

- e. Press the **PTT** button to transmit on the displayed zone channel.

- Select a channel using the radio menu Channel Up or Channel Down:

- a. ▲ or ▼ to ChUp or ChDn.



- b. Press the **Menu Select** button directly below ChUp or ChDn.

Positions of ChUp and ChDn on the display may differ each time you release the **Menu Select** button. Read carefully before you press.

- c. Press the **PTT** button to transmit on the displayed zone and channel.

Selecting a Channel by using Channel Search Button

This feature allows you to do a quick search for a specific channel in your radio by keying in the alias of the channel. Your radio prompts the first found channel if a match is found.

- 1 Perform one of the following actions:
 - Press the preprogrammed **Channel Search** button.
 -  or  to **CSrh** and press the **Menu Select** button directly below **CSrh**.

A blinking cursor appears on the **Channel Search** screen.

-
- 2 Use the **keypad** to type or edit your channel name.

 - 3 To initiate searching, press the **Menu Select** button directly below **CSrh** once the entry is done.

To exit this procedure, press the **Menu Select** button directly below **Cnc1**.

One of the following scenarios occurs:

- The display shows **Searching**. Once found, the display shows the matched channel name and the radio changes its transmission to the selected channel.
- If the radio is triggered to search for an empty entry, the display shows **Invalid entry**. Repeat [step 2](#) to search again.
- If the entry does not match, the display shows **Channel name not found**. Repeat [step 2](#) to search again; or press  or the **Menu Select** button directly below **Exit** to exit.

Mode Select Feature

Mode Select allows a long press to save the current zone and channel of your radio to a programmable button, keypad button, or a softkey; then once programmed, the short-press of that button or softkey changes the transmission to the saved zone and channel.

There are two methods to save the selected zone and channel:

- Softkeys
- Programmable buttons and keypad buttons (digit 0 to 9)

**NOTICE:**

Your radio must be preprogrammed for you to use this feature.

Saving a Zone and a Channel to a Softkey

Five softkeys are available for you to save the frequently used zone and channel.

- 1 Toggle from your current zone and channel to the required zone and channel.

- 2 ◀ or ▶ to MS1, MS2 ... or MS5.

- 3 Press and hold the **Menu Select** button directly below one of the softkey (MS1–MS5).

You hear a short, medium-pitched tone when the zone and channel is saved.

**NOTICE:**

To change the programmed zone and channel, repeat this procedure.

Short press of the programmed softkey changes your current transmission to the zone and channel programmed in this softkey.

Saving a Zone and a Channel to a Button

You can save the frequently used zone and channel to the programmable buttons and keypad digit 0 to 9 buttons.

- 1 Toggle from your current zone and channel to the required zone and channel.

- 2 Press and hold the button you desire to program.

You hear a short, medium-pitched tone when the zone and channel is saved.

**NOTICE:**

Repeat this procedure to change the zone and channel of the programmed button.

Short press of the programmed button changes your current transmission to the zone and channel programmed in this button.

Receiving and Responding to a Radio Call

Once you have selected the required channel and/or zone, you can proceed to receive and respond to calls.

The radio shows different indicators based on the system the radio is configured.

- The LED lights up solid red while the radio is transmitting.
- In conventional mode, the LED lights up solid yellow when the radio is receiving a transmission.
- In trunking mode, there is no LED indication when the radio receives a transmission.
- If the radio is receiving a secure transmission, the LED blinks yellow.

Receiving and Responding to a Talkgroup Call

To receive a call from a group of users, your radio must be configured as part of that talkgroup.

When you receive a talkgroup call (while on the Home screen) the radio displays the following depending on the system your radio is configured to:

- For ASTRO Conventional system, the LED lights up solid yellow. The display shows the talkgroup alias or ID, and the caller alias or ID.
- For Trunking system, the display shows the caller alias or ID.
 - 1 Hold the radio vertically 1 to 2 inches (2.5 to 5.0 cm) from your mouth.

 - 2 Press the **PTT** button to respond to the call. The LED lights up solid red.

 - 3 Release the **PTT** button to listen.

See also [Making a Talkgroup Call on page 71](#) for details on making a Talkgroup Call.

Receiving and Responding to a Private Call (Trunking Only)

A Private Call is a call from one individual radio to another.

The one-to-one call between the two radios are not heard by the others in the current talkgroup. The calling radio automatically verifies that the receiving radio is active on the system and can display the caller ID.



NOTICE:

With the inactivity timer enabled (optional), when there is no response from the receiving radio, the calling radio exits the call with Menu Inactive Exit tone after the timer expires.

When you receive a Private Call, you hear two alert tones and the LED blinks green. The display shows **Call received** and the call received icon blinks.

- 1 Perform one of the following actions:
 - Press the **Menu Select** button directly below **Resp.**
 - Press the **Call Response** button within 20 seconds after the call indicators begin.

If the caller alias is in the call list, the display shows the caller alias during the call.

If the caller name is not in the call list, the display shows the caller ID.

- 2 Press and hold the **PTT** button to talk. Release the **PTT** button to listen.

- 3 Press  or the **Call Response** button to hang up and return to the Home screen.

See also [Making a Private Call \(Trunking Only\)](#) on page 72 for details on making a Private Call.

Receiving and Responding to a Telephone Call (Trunking Only)

This feature allows you to receive calls similar to standard phone calls from a landline phone.



NOTICE:

With the inactivity timer enabled (optional), if there is no response to the call after the timer expires, your radio exits the call with Menu Inactive Exit tone.

When you receive a Telephone Call, you hear a telephone-type ringing and the LED blinks green. The backlight of the

screen and the bar turns green. The display shows `Phone call` and the call received icon blinks.

- 1 Press the **Call Response** button within 20 seconds after the call indicators begin.

- 2 Press and hold the **PTT** button to talk. Release the **PTT** button to listen.

- 3 Press  or the **Call Response** button to hang up and return to the Home screen.

See also [Making a Telephone Call \(Trunking Only\) on page 74](#) for details on making a Telephone Call.

Methods to Make a Radio Call

You can select a zone, channel, subscriber ID, or talkgroup by using:

- The preprogrammed **Zone** switch.
- The **16-Position Select Channel Knob**.
- A preprogrammed **One Touch Call** button.
- The Contacts list (see [Viewing Details of a Contact on page 91](#)).



NOTICE:

The radio automatically exits the feature, if the feature inactivity timer is enabled, when the radio is left idle and the timer expires. You will hear the Menu Inactive Exit Tone upon feature exit.

Making a Talkgroup Call

To make a call to a group of users, your radio must be configured as part of that talkgroup.

- 1 Turn the **16-Position Select Channel Knob** to select the channel with the desired talkgroup.

- 2 Hold the radio vertically 1 to 2 inches (2.5 to 5.0 cm) from your mouth.

- 3 Press the **PTT** button to make the call.
The radio shows different indicators based on the system the radio is configured.
 - For ASTRO Conventional system, the LED lights up solid red. The display shows the talkgroup alias or ID.
 - For Trunking system, the LED lights up solid red.



4 Speak clearly into the microphone.



5 Release the **PTT** button to listen.

Making a Private Call (Trunking Only)

Your radio must be preprogrammed for you to use this feature.

This feature allows you to send an individual Call Alert or page if there is no answer from the target radio.

- 1 Perform one of the following actions:
 - To access this feature using a preprogrammed button, press the preprogrammed **Quick Access (One-Touch) Private Call** button to dial the preprogrammed ID (number) and initiate the Private Call. Proceed to [step 4](#).
 -  or  to **Call** , and press the **Menu Select** button directly below **Call** .
The display shows the last transmitted or received ID.
 - 2 To select the required ID, perform one of the following actions:
-

- Press the **Menu Select** button directly below **Cnts** to scroll through and select the required ID.
 - Press the **Menu Select** button directly below **LNum** to go to the last number dialed.
 -  or  to the required ID.
 - Use the **keypad** to enter the required ID.
-

3 Press the **PTT** button to initiate the Private Call.
The display shows **Calling... <Number>**.

4 Hold the radio vertically 1 to 2 inches (2.5 to 5.0 cm) from your mouth.
When you are connected, the display shows the ID of the target radio.
If no acknowledgment is received, the display shows **No acknowledge**.

5 Press and hold the **PTT** button to talk. Release the **PTT** button to listen.

6 Press  to return to the **Home** screen.

Making an Enhanced Private Call (Trunking Only)

Your radio must be preprogrammed to allow you to use this feature.

This feature allows you to send an individual **Call Alert Page** if there is no answer from the target radio. See [Sending a Call Alert Page on page 97](#) for more information.

- 1 Perform one of the following actions:
 - To access this feature using a preprogrammed button, press the preprogrammed **Quick Access (One-Touch) Enhanced Private Call** button to dial the preprogrammed ID (number) and initiate the Private Call. Proceed to [step 4](#).
 - **◀** or **▶** to **Call**, and press the **Menu Select** button directly below **Call**.
The display shows the last transmitted or received ID.
-
- 2 To select the required ID, perform one of the following actions:

- Press the **Menu Select** button directly below **Cnts** to scroll through and select the required ID.
 - Press the **Menu Select** button directly below **LNum** to go to the last number dialed.
 - **▲** or **▼** to the required ID.
 - Use the **keypad** to enter the required ID.
-

- 3 Press the **PTT** button to initiate the Private Call.
The display shows **Calling... <Number>**.
-

- 4 Hold the radio vertically 1 to 2 inches (2.5 to 5.0 cm) from your mouth.

When you are connected, the display shows the ID of the target radio.

If no acknowledgment is received, the display shows **No acknowledge**.



If the target radio does not respond before the time out, the display shows **No answer**.

- 5 Press and hold the **PTT** button to talk. Release the **PTT** button to listen.
-



- 6 Press  to return to the **Home** screen.
-

Making a Telephone Call (Trunking Only)

This feature allows you to make calls similar to standard phone calls to a mobile or landline phone.

- 1 Perform one of the following actions:
 - To access this feature using a preprogrammed button, press the preprogrammed **Quick Access (One-Touch) Phone Call** button to dial the preprogrammed phone number. Proceed to [step 4](#).
 -  or  to **Phon**, and press the **Menu Select** button directly below **Phon**.
The display shows the last transmitted or received ID.

- 2 To select the required ID, perform one of the following actions:
 - Press the **Menu Select** button directly below **Cnts** to scroll through and select the required ID.

- Press the **Menu Select** button directly below **LNum** to go to the last number dialed.
 -  or  to the required phone number.
 - Use the keypad to enter the required phone number.
-

- 3 Press the **PTT** button to dial the phone number.
-

- 4 Hold the radio vertically 1 to 2 inches (2.5 to 5.0 cm) from your mouth.
-

- 5 When your call is answered, press and hold the **PTT** button to talk. Release the **PTT** button to listen.
-

- 6 Press  to return to the **Home** screen.
-

See [Phone Call Displays and Alerts on page 62](#) for more information if your call is not answered.

Switching Between Repeater or Direct Operation Button

The Repeater Operation increases the radio coverage area by connecting with other radios through a repeater. The transmit and receive frequencies are different.

The Direct or “talkaround operation” allows you to bypass the repeater and connect directly to another radio. The transmit and receive frequencies are the same.

Perform one of the following actions:

- Press the preprogrammed **Repeater/Direct** switch to toggle between talkaround and repeater modes.
- ◀ or ▶ to **Dir** and press the **Menu Select** button directly below **Dir**.

The display shows `Repeater mode` if the radio is currently in Repeater mode.

The display shows `Direct mode` and the Talkaround icon if the radio is currently in Direct mode (during conventional operation only).

Monitor Feature

The monitor feature is used to make sure that a channel is clear before transmitting.

The lack of static on a digital channel when the users switch from analog to digital radios is not an indication that the radio is malfunctioning.

Digital technology quiets the transmission by removing the noise from the signal and allows only the clear voice or data information to be heard.

Monitoring a Channel

Do one of the followings to monitor a channel. You can use these options interchangeably depending on your preference and the programmed functions.

- Monitoring a Channel with **Volume Set** button.
 - a. Select the desired zone and channel.
 - b. Press and hold the **Volume Set** button to hear the volume set tone.
 - c. Adjust the **Volume Control Knob** if necessary.
 - d. Release the **Volume Set** button.
 - e. Press and hold the **PTT** button to transmit.
The LED lights up solid red.
 - f. Release the **PTT** button to receive (listen).
- Monitoring a Channel with **Monitor** button.
 - a. Press the preprogrammed **Monitor** button.
 - b. Adjust the **Volume Control Knob** if necessary.

- c. Press and hold the **PTT** button to transmit.
The LED lights up solid red.
- d. Release the **PTT** button to receive (listen).
The Carrier Squelch indicator appears on the display when you monitor a channel using the preprogrammed **Monitor** button.
- Monitoring a Channel using the selected zone channel.
 - a. Select the desired zone and channel.
 - b. Listen for a transmission.
 - c. Adjust the **Volume Control Knob** if necessary.
 - d. Press and hold the **PTT** button to transmit.
The LED lights up solid red.
 - e. Release the **PTT** button to receive (listen).

Monitoring Conventional Mode

Your radio may be preprogrammed to receive Private-Line® (PL) calls.

- 1 Momentarily press the **Monitor** button to listen for activity.
The Carrier Squelch indicator appears on the display.

- 2 Press and hold the **Monitor** button to set continuous monitor operation.
The duration of the button press is programmable.

- 3 Press the **Monitor** button again, or the **PTT** button, to return to the original squelch setting.
If you try to transmit on a receive-only channel, you hear an invalid tone until you release the **PTT** button.

Advanced Features

This chapter explains the operations of the features available in your radio.

Advanced Call Features

This chapter explains the operations of the call features available in your radio.

Selective Call (ASTRO Conventional Only)

A Selective Call is a call from an individual radio to another individual radio with privacy.

Receiving a Selective Call

When you receive a Selective Call, the radio indicates one of the followings:

- You hear two alert tones and the LED lights up solid yellow to indicate the transmitting radio is still sending signal. The call received icons blinks and the display shows `Call received`.

- The LED blinks solid green once to indicate the transmitting radio is pending to receive signal.

The speaker unmutes.

- 1 Hold the radio vertically 1 to 2 inches (2.5 to 5.0 cm) from your mouth.
-
- 2 Press and hold the **PTT** button to talk. Release the **PTT** button to listen.
-

Making a Selective Call

Your radio must be preprogrammed for you to use this feature.

- 1 Perform one of the following actions:
 - To access this feature by using a preprogrammed button, press the preprogrammed **Quick Access (One-Touch) Selective Call** button to dial the preprogrammed ID. Proceed to [step 3](#).
 - **◀** or **▶** to `Call`, and press the **Menu Select** button directly below `Call`.
The display shows the last transmitted or received ID.
-

- 2 To select the required ID, perform one of the following actions:
 - Press the **Menu Select** button directly below **Cnt** to scroll through and select the required ID.
 - Press the **Menu Select** button directly below **LNum** to go to the last number dialed.
 - **▲** or **▼** to the required ID.
 - Use the keypad to enter the required ID.
-

- 3 Hold the radio vertically 1 to 2 inches (2.5 to 5.0 cm) from your mouth.
-

- 4 Press and hold the **PTT** button to start the Selective Call.

The display shows the ID of the target radio.

- 5 Release the **PTT** button to listen.
-

- 6 Press **Home** to return to the **Home** screen.
-

Talkgroup Call Feature (Conventional Operation Only)

This feature allows you to define a group of conventional system users so that they can share the use of a conventional channel.



NOTICE:

Encryption keys are associated to talkgroups. When talkgroups are associated, encryption keys are changed by changing the active talkgroup. See [Secure Operations on page 135](#) for more information.

Selecting a Talkgroup

- 1 **◀** or **▶** to **Tgrp** and press the **Menu Select** button directly below **Tgrp**.

The display shows the last Talkgroup that was selected and stored.

- 2 Perform one of the following actions:
 - **▲** or **▼** to **Preset** for the preset preprogrammed Talkgroup.

- ▲ or ▼ to the required Talkgroup.
- Use the **keypad** to enter the number of the corresponding Talkgroup in the list.

-
- 3** Press the **Menu Select** button directly below `Sel` to save the currently selected Talkgroup and return to the **Home** screen.

If the encryption key associated to the new Talkgroup is erased, you hear a momentary key fail tone and the display shows `Key fail`.

If the encryption key that is associated to the new Talkgroup is not allowed, you hear a momentary key fail tone and the display shows `Illegal key`.

-
- 4** Press  to return to the **Home** screen.
-

Sending a Status Call

This feature allows you to send data calls to the dispatcher about a predefined status.

Each status can have up to a 14-character name. A maximum of eight status conditions is possible.



NOTICE:

The radio automatically exits the feature, if the feature inactivity timer is enabled. You will hear the Menu Inactive Exit Tone upon feature exit.

- 1 Perform one of the following actions:
 - Press the preprogrammed **Status** button.
 - ◀ or ▶ to `Sts` and press the **Menu Select** button directly below `Sts`.

The display shows the last acknowledged status call, or the first status in the list.

-
- 2 Perform one of the following actions:
 - ▲ or ▼ to the required status.
 - Use the **keypad** to enter a number corresponding to the location in the status list.
-

- 3 Press the **PTT** button to send the status.

When the dispatcher acknowledges, you hear four tones and the display shows `Ack received`. The radio returns to normal dispatch operation.

If no acknowledgment is received, you hear a low-pitched tone and the display shows No acknowledge.

-
- 4 Press  to return to the **Home** screen.

No traffic is heard on trunked channels while Status Calls is selected. If the radio detects no Status Call activity for six seconds, an alert tone sounds until you press  or the **PTT** button.

Responding to the Dynamic Regrouping Feature (Trunking Only)

This feature allows the dispatcher to temporarily reassign selected radios to a particular channel where they can communicate with each other. This feature is typically used during special operations and is enabled by a qualified radio technician.

You will not notice whether your radio has this feature enabled until a dynamic regrouping command is sent by the dispatcher.



NOTICE:

If you try to access a zone or channel that has been reserved by the dispatcher as a dynamically regrouped mode for other users, you hear an invalid tone.

When your radio is dynamically regrouped, it automatically switches to the dynamically regrouped channel. You hear a Gurgle tone and the display shows the dynamically regrouped channel's name.

Press the **PTT** button to talk. Release **PTT** button to listen.



When the dispatcher cancels dynamic regrouping, the radio automatically returns to the zone and channel that you were using before the radio was dynamically regrouped.

Requesting a Reprogram (Trunking Only)

This feature allows you to notify the dispatcher when you want a new dynamic regrouping assignment.

Perform one of the following actions:

- Press the preprogrammed **Reprogram Request** button to send reprogram request to the dispatcher.

-  or  to Rpgm then press the **Menu Select** button directly below Rpgm to send reprogram request to the dispatcher.

The display shows Reprogram Rqst and Please wait.

If you hear five beeps, the dispatcher has acknowledged the reprogram request. The display shows Ack received and the radio returns to the **Home** screen.

If the dispatcher does not acknowledge the reprogram request within six seconds, you hear a low-pitched alert tone and the display shows No acknowledge. Try again or press  to cancel and return to the **Home** screen.

Classification of Regrouped Radios

The dispatcher can classify regrouped radios into either of two categories:

Select Enabled

Select-enabled radios are free to change to any available channel, including the dynamic-regrouping channel, once the user has selected the dynamic-regrouping position.

Select Disabled

Select-disabled radios cannot change channels while dynamically regrouped. The dispatcher has forced the radio to remain on the dynamic-regrouping channel.

The Scan or Private Call feature cannot be selected while your radio is Select Disabled.

Dynamic Zone Programming (DZP)



NOTICE:

Your radio must be preprogrammed to allow you to use this feature. This feature works on the condition at least one zone in the radio must be a non-dynamic zone.

This feature provides one or more Dynamic Zones to store frequently used channels be it conventional or trunking. These dynamic channels are saved from pre-existing (non-dynamic) channels in the radio. This saves the time and effort from the regular navigation around the working zones and channels. User can also delete or update the list in the Dynamic Zone.

Entering the Dynamic Zone to Select a Dynamic Channel

- 1 ◀ or ▶ to Zone then press the **Menu Select** button directly below Zone.

The display shows the **Zone** screen.

- 2 ▲ or ▼ to <# Dynamic Zone Channels>.²
-

- 3 Perform one of the following actions:

- Press the **Menu Select** button below Sel to select.
- Press the **Menu Select** button below Exit to exit.

If you have selected one of the Dynamic Zone Channels list, the display returns to **Home** screen with the selected <# Dynamic Zone Channels> shown on the screen.²

If you have selected Exit without selecting any Dynamic Zone Channels list, the display returns to **Home** screen without any changes.

Saving a Channel in the Dynamic Zone from List Selection

The radio must be in Dynamic Zone in order to perform this operation.

- 1 ◀ or ▶ to ZnPr. Press the **Menu Select** button directly below ZnPr to enter **Program Zone** screen.
-

- 2 Press the **Menu Select** button directly below Edit. The display shows **Search Options** screen.
-

- 3 ▲ or ▼ to List Selection. Press the **Menu Select** button directly below Sel . The display shows **Select Zone** screen.
-

- 4 ▲ or ▼ to the required zone. Press the **Menu Select** button directly below Sel . The display shows **Select Chan** screen.
-

² # indicates number of the channel on the 16-Position Switch which are numbered from 1 to 16.

- 5 ▲ or ▼ to the required channel. Press the **Menu Select** button directly below Sel .

The display shows Channel updated.

- 6 Press the **Menu Select** button directly below Exit to return to **Home** screen.
-

Saving a Channel in the Dynamic Zone from Channel Name

The radio must be in Dynamic Zone in order to perform this operation.

- 1 ◀ or ▶ to ZnPr then press the **Menu Select** button directly below ZnPr to enter **Program Zone** screen.
-

- 2 Press the **Menu Select** button directly below Edit.
The display shows **Search Options** screen.
-

- 3 ▲ or ▼ to Channel Name then press the **Menu Select** button directly below Sel .

The display shows a blinking cursor on the **Channel Name** screen.

- 4 Use the **keypad** to type or edit the channel name.
-

- 5 Press the **Menu Select** button directly below Srch once the entry is done to initiate searching.

You can cancel this operation at this step by pressing the **Menu Select** button directly below Cncl to return to **Search Options** screen.

The display shows Searching.... Once found, the display shows Channel updated.

If the radio is triggered to search for an empty entry, the display shows Invalid entry.

If the entry does not match, the display shows Channel name not found. Repeat from [step 4](#) or [step 5](#) to search again.

- 6 Press  to return to the **Home** screen.
-

Deleting a Channel in the Dynamic Zone

The radio must be in Dynamic Zone in order to perform this operation.

- 1 **◀** or **▶** to **ZnPr** then press the **Menu Select** button directly below **ZnPr** to enter **Program Zone** screen.

The display shows the dynamic channels list.

- 2 **▲** or **▼** to the saved dynamic channel then press the **Menu Select** button directly below **Del**.

The display shows **Channel deleted** screen.

- 3 Press the **Menu Select** button below **Exit** to return to **Home** screen.

The **Home** screen shows `<Dynamic Zone Channels>`.

If the channel deleted is the Home channel, the **Home** screen shows `<Zone Name>"Blank"`.

Zone to Zone Cloning

Zone to Zone Cloning clones conventional zones from one radio to another. This feature allows you to select the clone enabled zones from a source radio and clone them into a target radio.

You can clone the zones by using a cable that connects the source and target radios.

Connect two radios with a clone cable. The target radio must be digital, band, and FCC mandate compatible with the source radio.

- 1 On the source radio, press the **Menu Select** button directly below **Clon**.
- 2 Press the **Menu Select** button directly below **Sel** to select source zone.
- 3 When connecting to the target radio, one of the following scenarios occurs:
 - If the radio is compatible, the radio displays `Target radio connected`. Proceed to [step 4](#).
 - If the radio is not compatible, the radio displays `Target radio incompatible`. Press the **Menu**

Select button directly below **Ok** and the radio returns to the previous screen.

Once connected, the zone clone status is displayed on the right.

4 Press the **Menu Select** button directly below **Next** to accept the source zones selection. One of the following scenarios occurs:

- If you select a single source zone, press the **Menu Select** button directly below **Sel** to select the target zones for cloning.
 - If you select multi-source zones, the radio displays `Confirm target` and shows the automatically selected target zones and source zones mapping.
 - If the selected multi-source zones exceed the last clonable target zone, the radio displays `<#> src zones unselected and Sel exceed max tgt zone alternatively.`
-

5 Press the **Menu Select** button directly below **Clone** to begin cloning.

The radio displays `Enter password` if the protected target zone is selected.

6 Enter the password and press the **Menu Select** button directly below **Ok** to start cloning.

The radio displays `Cloning.<Current cloning zone>`. One of the following scenarios occurs:

- If the cloning is successful, a tone sounds, the radio displays `Clone successful` and the source zone alias is displayed on the right.
- If the cloning is not successful, a tone sounds and the radio displays `Clone failed`. Press the **Back** button to enter the source zone list.
- If you press the **Home** button, the radio aborts cloning.



NOTICE:

The target radio enters programming mode during cloning and resets after cloning is completed.

Contacts

This feature provides “address-book” capabilities on your radio. Each entry corresponds to an alias (name) or ID (number) that you use to initiate a call.

Contact entries are alphabetically sorted according to entry alias. Each alias can have up to five IDs of different call types associated with it.

Additionally, each entry, depending on context (conventional, trunking, or phone), associates with one or more of the four types of calls: Phone Call, Selective Call, Private Call, or Call Alert.

Each entry within Contacts contains the following information:

- Call Alias (Name)
- Call ID (Number)
- Call Type (Icon)
- WACN ID (Astro 25 Trunking IDs only)
- System ID



NOTICE:

Your radio must be preprogrammed to allow you to add, edit, or delete the contact entries.

Your radio also supports a maximum of 50 call lists. Each list can store up to 100 IDs (numbers).





NOTICE:

Your radio is preprogrammed with a number of contacts per Call Lists. Check with your dealer or system administrator for more information.

The radio automatically exits the feature, if the feature inactivity timer is enabled, when the radio is left idle and the timer expires. You hear the Menu Inactive Exit Tone upon feature exit.

Making a Private Call from Contacts

Your radio must be preprogrammed to allow you to use this feature.

- 1  or  to `Cnts` and press the **Menu Select** button directly below `Cnts`.

The entries are alphabetically sorted.

- 2  or  to the required subscriber alias.
-

- 3 Perform one of the following actions:
 - Press the **Menu Select** button directly below `Optn` and proceed to the next step.

- ◀ or ▶ to scroll through the available IDs for the selected subscriber alias and proceed to [step 6](#).

4 ▲ or ▼ to **Call** and press the **Menu Select** button directly below **Sel**.

5 ▲ or ▼ to select the call type.

6 Hold the radio vertically 1 to 2 inches (2.5 to 5.0 cm) from your mouth.

7 Press the **PTT** button to initiate the call.

During the call, the display shows the subscriber alias.

8 Press and hold the **PTT** button to talk. Release the **PTT** button to listen.

The LED lights up solid red when the **PTT** button is pressed.

If there is no voice activity for a preprogrammed period of time, the call ends.

If the call reaches the maximum ring time, the call ends.

Adding a New Contact Entry

1 ◀ or ▶ to **Cnts** and press the **Menu Select** button directly below **Cnts**.

The entries are alphabetically sorted.

2 ▲ or ▼ to [**New Contact**] and press the **Menu Select** button directly below **Sel**.

3 ▲ or ▼ to **Name** and press the **Menu Select** button directly below **Edit**.

The display shows **Edit name** and a blinking cursor appears.

4 Use the **keypad** to enter the name and press the **Menu Select** button directly below **Ok** once you have entered the name.

To cancel this operation, press the **Menu Select** button directly below **Cnc1** to return to the previous screen.

5 ▲ or ▼ to [**Add Number**] and press the **Menu Select** button directly below **Sel**.

- 6 ▲ or ▼ to Number 1 and press the **Menu Select** button directly below Edit .

The display shows Edit Num 1 and a blinking cursor appears.

- 7 Use the **keypad** to enter the number and press the **Menu Select** button directly below Ok once you have entered the number.

To cancel this operation, press the **Menu Select** button directly below Cncl to return to the previous screen.

- 8 Perform one of the following actions per the information you need to add to current name:

- ▲ or ▼ to Type 1 and press the **Menu Select** button directly below Edit.
▲ or ▼ to the required mode and press the **Menu Select** button directly below Ok .
 - Repeat [step 6](#) through [step 7](#) to enter or edit the existing system IDs.
 - Repeat [step 5](#) through [step 7](#) to add a new number.
-

- 9 Press the **Menu Select** button directly below Done once you have finished.

The display shows <Entry> Stored, confirming that the contact entry has been added.
The radio returns to the main **Contacts** screen.

Deleting a Contact Entry

- 1 ◀ or ▶ to Cnts and press the **Menu Select** button directly below Cnts .

The entries are alphabetically sorted.

- 2 ▲ or ▼ to the entry you want to delete and press the **Menu Select** button directly below Optn .
-

- 3 ▲ or ▼ to Del and press the **Menu Select** button directly below Sel .

The display shows <Entry> confirm del?.

- 4 Select the **Menu Select** button directly below `Yes` to delete the entry, or `No` to cancel and return to the main screen of **Contacts**.

The display shows `<Entry>` deleted and the radio returns to the main screen of **Contacts**.

- ▲ or ▼ to `Cncl` to cancel and return to the main screen of **Contacts**.

The display shows `Please wait momentarily before showing <Entry> added to Call List`, confirming the addition of the contact to the list.

The radio returns to the main display of **Contacts**.

Adding a Contact to a Call List

- 1 ◀ or ▶ to `Cnts` and press the **Menu Select** button directly below `Cnts`.

The entries are alphabetically sorted.

- 2 ▲ or ▼ to the entry you want to add and press the **Menu Select** button directly below `Optn`.
-

- 3 ▲ or ▼ to `Add to CallLst` and press the **Menu Select** button directly below `Se1`.
-

- 4 Perform one of the following actions:

- ▲ or ▼ to the required Call List and press the **Menu Select** button directly below `Add` to add to the Call List.

Removing a Contact from a Call List

- 1 ◀ or ▶ to `Cnts` and press the **Menu Select** button directly below `Cnts`.

The entries are alphabetically sorted.

- 2 ▲ or ▼ to the entry you want to delete and press the **Menu Select** button directly below `Optn`.
-

- 3 ▲ or ▼ to `Rm frm CallLst` and press the **Menu Select** button directly below `Se1`.

The display shows `Remove <Entry> frm Call List?`.

- 4 Press the **Menu Select** button directly below **Yes** to remove the entry from the Call List, or **No** to cancel and return to the main display of **Contacts**.

The display shows **Please wait momentarily before showing <Entry> removed from Call List,** confirming the removal of the contact from the list.

The radio returns to the main display of **Contacts**.

Methods of Contact Editing in a Call List

This feature allows you to edit contacts in a call list.

Editing an Entry Alias

- 1 **◀** or **▶** to **Cnts** and press the **Menu Select** button directly below **Cnts** .

The entries are alphabetically sorted.

- 2 **▲** or **▼** to the entry you want to edit and press the **Menu Select** button directly below **Optn** .
-

- 3 **▲** or **▼** to **Edit** and press the **Menu Select** button directly below **Sel** .
-

- 4 **▲** or **▼** to the entry alias you wish to change and press the **Menu Select** button directly below **Edit** .
A blinking cursor appears.
-

- 5 Use the **keypad** to edit the name and press the **Menu Select** button directly below **Ok** once you have finished.

The display returns to the **Edit Contact** screen.

- 6 Press the **Menu Select** button directly below **Done** to save your changes and return to the main screen of **Contacts**.
-

Editing as Entry ID

- 1 **◀** or **▶** to **Cnts** and press the **Menu Select** button directly below **Cnts** .

The entries are alphabetically sorted.

- 2 ▲ or ▼ to the entry you want to edit and press the **Menu Select** button directly below `Optn` .

- 3 ▲ or ▼ to `Edit` and press the **Menu Select** button directly below `Sel` .

- 4 ▲ or ▼ to the entry ID you wish to change and press the **Menu Select** button directly below `Edit` .
A blinking cursor appears.

- 5 Use the keypad to edit the number and press the **Menu Select** button directly below `Ok` once you have finished.
The display returns to the **Edit Contact** screen.

- 6 Press the **Menu Select** button directly below `Done` to save your changes and return to the main screen of **Contacts**.

Editing a Call Type

- 1 ◀ or ▶ to `Cnts` and press the **Menu Select** button directly below `Cnts` .

The entries are alphabetically sorted.

- 2 ▲ or ▼ to the entry you want to edit and press the **Menu Select** button directly below `Optn` .

- 3 ▲ or ▼ to `Edit` and press the **Menu Select** button directly below `Sel` .

- 4 ▲ or ▼ to `Type` and press the **Menu Select** button directly below `Edit` .

- 5 ▲ or ▼ to choose from the list of call types given and press the **Menu Select** button directly below `Ok` .
The display returns to the **Edit Contact** screen.

- 6 Press the **Menu Select** button directly below `Done` to save your changes and return to the main screen of **Contacts**.

Viewing Details of a Contact

- 1 ◀ or ▶ to `Cnts` and press the **Menu Select** button directly below `Cnts` .

The entries are alphabetically sorted.

2 ▲ or ▼ to the entry you want to view and press the **Menu Select** button directly below `Optn` .

3 ▲ or ▼ to `View` and press the **Menu Select** button directly below `Sel` .

The display shows all the numbers associated with the entry.

Scan Lists

Scan lists are created and assigned to individual channels/groups. Your radio scans for voice activity by cycling through the channel/group sequence specified in the scan list for the current channel/group.

Your radio supports different types of Scan Lists:

- Trunking Priority Monitor Scan List
- Conventional Scan List
- Talkgroup Scan List

Please refer to a qualified radio technician for the maximum number of Scan Lists can be programmed in your radio.

These lists must be preprogrammed by a qualified radio technician.

Intelligent Priority Scan

Intelligent Priority Scan feature allows you to add or delete conventional channels and trunking talkgroups from multiple system into the priority scan lists.

You can add or delete priority scan list members and assign priorities using the preprogrammed **Scan List Programming** button. Radio displays the priority level of the scanned member.



NOTICE:

Priority-One channel and Priority-Two channel member may belong to different Talkgroup Scan systems.

When the radio locks onto a channel in the Intelligent Priority Scan list, radio scans for higher priority member within the same Trunking or Conventional system.

Viewing a Scan List

1 ◀ or ▶ to `ScnL` and press the **Menu Select** button directly below `ScnL` .

2 ▲ or ▼ to view the members on the list.

3 Press  to exit the current display and return to the Home screen.

Editing the Scan List

This feature allows you to change scan list members and priorities.

- 1 Perform one of the following actions:
 - Long press the preprogrammed **Scan List Programming** button (side button).
 - Move the preprogrammed **Scan List Programming** switch to programming position.
 - ◀ or ▶ to **ScnL** then press the **Menu Select** button directly below **ScnL**.

The display shows the lists that can be changed.

2 ▲ or ▼ to the entry you want to edit.

3 Perform one of the following actions:

- Press the **Menu Select** button directly below **Se1** to add and/or change the priority of the currently displayed channel in the scan list.
 - Press the **Menu Select** button directly below **De1** to delete the currently displayed channel from the scan list.
 - Press the **Menu Select** button directly below **Rc1** to view the next member of the scan list.
-

- 4 Perform one of the following actions to select another channel that needs to be added or deleted then repeat [step 3](#). Otherwise, proceed to the next step.
 - ▲ or ▼ to the desired channel.
 - Use the keypad to enter the desired channel name.
 - Use the **16-Position Select** knob to select the channel.
-

- 5 Perform one of the following actions:
 - Move the **Scan List Programming** switch out of programming position.

- Press  to exit scan list programming and return to the Home screen.
-

See [Viewing and Changing the Priority Status on page 94](#) for more information on how to add and/or change the priority of the currently displayed channel in the scan list.

Changing the Scan List Status



- 1 Perform one of the following actions:
 - Long press the preprogrammed **Scan List Programming** button (side button).
 - Move the preprogrammed **Scan List Programming** switch to programming position.

The display shows the programming mode icon and the first list member.

- 2  or  to the member you want to edit.
-

- 3 Perform one of the following actions:
 - Press the **Select** button once to add the currently displayed channel to the scan list.

- Press the **Select** button one or more times to change the scan list status icon of the currently displayed channel.
-

- 4 Perform one of the following actions:
 -  or  to select more list members whose scan status you want to change.
 - Use the **keypad** to go directly to that scan list member.
 - Use the **16-Position Select** knob to select another scan list member.
-

- 5 Move the **Scan List Programming** switch out of programming position.
-

Viewing and Changing the Priority Status

Perform one of the following actions:

- Press the **Menu Select** button directly below  one or more times to change the priority status of the current displayed channel.

- Press the **Select** button one or more times to toggle between different status of the Scan List status icon of the current displayed channel.

The radio shows one of following priority status icons and scenarios:



- A **Scan** icon indicates that the current channel is in the scan list as a non-priority channel. The LED lights up solid green.
- A **Priority-One Channel Scan** icon indicates that the current channel is in the scan list as the Priority-One channel. The LED rapidly blinks green. You hear all traffic on the Priority-One channel, regardless of traffic on non-priority channels.
- A **Priority-Two Channel Scan** icon indicates that the current channel is in the scan list as the Priority-Two channel. The LED blinks green.
- No icon indicates that the current channel is deleted from the scan list.

Scan

This feature allows you to monitor traffic on different channels by scanning a preprogrammed list of channels.

Turning Scan On or Off

Perform one of the following actions:

- Press the preprogrammed **Scan** button to toggle `Scan On` or `Scan Off` to initiate or stop scan.
- Turn the preprogrammed **Scan** switch to the **Scan on** or **Scan off** position to initiate or stop scan.
-  or  to `Scan` and press the **Menu Select** button directly below `Scan`.

If the scan is enabled, the display shows `Scan on` and the scan status icon.

If the scan is disabled, the display shows `Scan Off`.

The radio returns to the Home screen.

Making a Dynamic Priority Change (Conventional Scan Only)

While the radio is scanning, the dynamic priority change feature allows you to temporarily change any channel in a scan list (except for the Priority-One channel) to the Priority-Two channel.

This change remains in effect until scan is turned off. Scan then reverts to the preprogrammed (original) setting.

- Making a Dynamic Priority Change using the preprogrammed **Dynamic Priority** button:
 - a. When the radio locks onto the channel designated as the new Priority-Two channel, press the preprogrammed **Dynamic Priority** button.

The radio continues scanning the remaining channels in the list.

Deleting a Nuisance Channel

If a channel continually generates unwanted calls or noise (termed “nuisance” channel), you can temporarily remove the unwanted channel from the scan list.

This capability does not apply to priority channels or the designated transmit channel.

When the radio is locked onto the channel to be deleted, perform one of the following actions:

- Press the preprogrammed **Nuisance Delete** button.
- ◀ or ▶ to **Nuis** and press the **Menu Select** button directly below **Nuis**.

The radio continues scanning the remaining channels in the list.

Restoring a Nuisance Channel

To restore the deleted nuisance channel, perform one of the following actions:

- Stop and restart a scan.
- Mode change to another channel and back to the original channel.
- Turn off the radio and then turn it on again.

Nuisance mode delete can be disabled by the system administrator.

Call Alert Paging

This feature allows your radio to work like a pager.

Even if other users are away from their radios, or if they are unable to hear their radios, you can send them an individual Call Alert page. You can also verify if a radio is active on the system.

Depending on how your radio is programmed, when you make an Enhanced Private Call, the radio either automatically sends a call alert page if there is no answer after the maximum ring time, or when you press the **PTT** button.



NOTICE:

This feature must be preprogrammed by a qualified radio technician.

Receiving a Call Alert Page

When you receive a Call Alert page, you hear four repeating alert tones and the LED blinks green. The call

received icon blinks and the display shows `Page received`.

Press any button to clear the Call Alert page.

See [Making a Talkgroup Call on page 71](#) or [Making a Private Call \(Trunking Only\) on page 72](#) for more information on returning the call.

Sending a Call Alert Page

Do one of the following to send a call alert page:



NOTICE:

If the feature inactivity timer is enabled, your radio automatically exits the feature when your radio is left idle long enough for the time to expire. You hear the Menu Inactive Exit Tone upon feature exit.

- Sending a call alert page using the preprogrammed **Quick Access (One-Touch) Call Alert Paging** button:
 - a. Press the preprogrammed **Quick Access (One-Touch) Call Alert Paging** button to send a page to the preprogrammed ID.

The display shows `Paging...<Number>`.

If the call alert page is sent successfully, you hear a tone and the display shows `Ack received`. The radio returns to the Home screen.

If the call alert page is not acknowledged, you hear a low tone and the display shows `No acknowledge`. Press the **Menu Select** button directly below `Ok` to return to the main screen for **Contacts**.

- Sending a call alert page using the radio menu `Page` :
 - a. `◀` or `▶` to `Page` .
 - b. Press the **Menu Select** button directly below `Page` .
 - c. Press the **Menu Select** button directly below `Cnts` to view the required ID, `▲` or `▼` to the required ID, or use the **keypad** to enter the required ID.
 - d. Press the **PTT** button to send the page.

The display shows `Paging...<Number>`.

If the call alert page is sent successfully, you hear a tone and the display shows `Ack received`. The radio returns to the Home screen.

If the call alert page is not acknowledged, you hear a low tone and the display shows `No acknowledge`. Press the **Menu Select** button directly below `Ok` to return to the main screen of **Contacts**.

- Sending a call alert page using the radio menu `Call` :
 - a. `◀` or `▶` to `Call` .
 - b. Press the **Menu Select** button directly below `Call` .
 - c. `▲` or `▼` to select the alias or ID, and press the **PTT** button to initiate the call.

If the target radio does not respond after a preprogrammed period of time, the display shows `Send page?`.

- d. To send the call alert page, press the **Menu Select** button directly below `Yes` . To exit the screen without sending the call alert page, press the **Menu Select** button directly below `No` .

The display shows `Paging...<Alias>`.

If the call alert page is sent successfully, you hear a tone and the display shows `Ack received`. The radio returns to the Home screen.

If the call alert page is not acknowledged, you hear a low tone and the display shows `No acknowledge`. Press the **Menu Select** button directly below `Ok` to return to the main screen of **Contacts**.

Emergency Operation

The Emergency feature is used to indicate a critical situation.

If the **Top (Orange)** button is preprogrammed to send an emergency signal, this signal overrides any other communication over the selected channel.

Your radio supports the following Emergency modes:

- Emergency Alarm
- Emergency Call (Trunking Only)
- Emergency Alarm with Emergency Call
- Silent Emergency Alarm

Check with your dealer or system administrator for more information on the programming of this feature.

Each channel can only assigned one of the Emergency modes above. The radio responds differently when pressing the preprogrammed **Emergency** button in each channel.

To exit emergency at any time, press and hold the preprogrammed **Emergency** button for about a second.



NOTICE:

The timer is programmable from 0–6250 milliseconds by a qualified technician.

Dispatch console that supports this feature can be programmed to clear the emergency state of the radio. Check with your dealer or system administrator for more information on dispatch console supporting this feature.

The radio operates in the normal dispatch manner while in Emergency Call, except if enabled, it returns to one of the following:

Tactical/Non-Revert

The radio sends emergency alarm and/or make emergency call on the current selected channel.

Non-Tactical/Revert for Conventional system

The radio reverts to the preprogrammed emergency channel to send alarm and/or make emergency call.

Non-Tactical/Revert for Trunking system

The radio reverts to the preprogrammed emergency talkgroup to send alarm and/or make emergency call.

Man Down is an alternate way to activate the Emergency feature on the condition the Emergency must be set up for this feature to operate.

The receiving radio distinguishes the two types of emergency by displaying the following:

- When receiving an Emergency, the radio displays `EA` received.
- When receiving a Man Down alarm, the radio displays `MDown` received.

The receiving radio mutes any incoming voice, then sounds an emergency receiving tone. The radio unmutes the voice after two seconds.

Distinguishing Emergency and Man Down feature is enabled through CPS configuration. Check with your dealer or system administrator for more information.

See [Man Down on page 110](#) for details.

Sending an Emergency Alarm

This feature allows you to send a data transmission, which identifies the radio sending the emergency, to the dispatcher.



NOTICE:

The default timer of **Emergency** button press to activate Emergency is 50 milliseconds. This timer is programmable from 50–6200 milliseconds by a qualified technician.

Press the preprogrammed **Emergency** button.

One of the following scenarios occurs:

- The display shows `Emergency` on the current zone and channel. You hear a short medium-pitched tone and the LED blinks red momentarily.
- The radio sounds a short low-pitched tone to indicate that the selected channel does not support emergency and rejects to launch emergency mode.

When you receive the dispatcher's acknowledgment, the display shows `Ack` received. Four tones sound, the alarm ends, and the radio exits the Emergency Alarm mode.

If no acknowledgment is received, the display shows **No acknowledge**. The alarm ends when the timer expires and the radio exits the Emergency Alarm mode.

Sending an Emergency Call (Trunking Only)

This feature gives your radio priority access to a talkgroup.

- 1 Press the preprogrammed **Emergency** button.

One of the following scenarios occurs:

- The display shows **Emergency** on the current zone and channel. You hear a short medium-pitched tone and the LED blinks red momentarily.
- You hear the radio sounds a short low-pitched tone to indicate the selected channel does not support emergency and rejects to launch emergency mode.

-
- 2 Hold the radio vertically 1 to 2 inches (2.5 to 5.0 cm) from your mouth.
-

- 3 Press and hold the **PTT** button. Speak clearly into the microphone.
-

- 4 Release the **PTT** button to end the transmission and wait for a response from the dispatcher.
-

- 5 To exit Emergency Call, press and hold the preprogrammed **Emergency** button for about a second.
-

Sending An Emergency Call With Hot Mic (Trunking Only)

This feature allows you to send an Emergency Call with hot mic to a group of radios.

Your radio must be programmed for this type of operation.

Your radio microphone is automatically activated, allowing you to communicate with the group of radios without pressing the **PTT** button. This activated microphone state is also known as hot mic. The hot mic applies to the first voice transmission from your radio during the Emergency call. For subsequent transmissions in the same Emergency call, you must press the **PTT** button.

Follow the procedure to send Emergency Call with hot mic on your radio.

- 1 Press the preprogrammed **Emergency** button.

One of the following scenarios occurs:

- The display shows `Emergency` on the current zone and channel. A tone sounds and the LED blinks red momentarily.
- A tone sounds to indicate the selected channel does not support emergency and rejects to launch emergency mode.

-
- 2 Hold the radio vertically 1 to 2 inches (2.5 to 5.0 cm) from your mouth.

-
- 3 The microphone remains active for the hot mic time specified in the radio's codeplug programming.

-
- 4 To exit Emergency Call, press and hold the preprogrammed **Emergency** button.
-

Sending an Emergency Alarm with Emergency Call

This feature gives your radio priority access on a channel for conventional system, and to a talkgroup for trunking system.

- 1 Press the preprogrammed **Emergency** button.

If successful, the display shows `Emergency` on the current zone and channel. You hear a short, medium-pitched tone and the LED blinks red momentarily.

The radio exits Emergency Alarm and enters the Emergency Call state when one of the following scenarios occur:

- You receive the dispatcher acknowledgment. The display shows `Ack received`.
- You receive no acknowledgment. The display shows `No acknowledge`.
- You press the **PTT** button while in the Emergency Alarm mode.

If unsuccessful, you hear the radio sounds a short low-pitched tone to indicate the selected channel

does not support emergency and rejects to launch emergency mode.

-
- 2 Hold the radio vertically 1 to 2 inches (2.5 to 5.0 cm) from your mouth.

 - 3 Press and hold the **PTT** button. Speak clearly into the microphone.

 - 4 Release the **PTT** button to end the transmission and wait for a response from the dispatcher.

 - 5 To exit Emergency Call, press and hold the preprogrammed **Emergency** button for about a second.

Turning off the radio also cancels the emergency state.

Sending An Emergency Alarm and Call with Hot Mic

This feature allows you to send an Emergency Alarm and Call with hot mic to a group of radios.

Your radio must be programmed for this type of operation.

Follow the procedure to send Emergency Alarms and Call with hot mic on your radio.

- 1 Press the preprogrammed **Emergency** button.

If successful, the display shows `Emergency` on the current zone and channel. A tone sounds and the LED blinks red momentarily.

The radio exits Emergency Alarm and enters the Emergency Call state when one of the following scenarios occur:

- You receive the dispatcher acknowledgment. The display shows `Ack received`.
- You receive no acknowledgment. The display shows `No acknowledge`.

If unsuccessful, a tone sounds to indicate the selected channel does not support emergency and rejects to launch emergency mode.

-
- 2 Hold the radio vertically 1 to 2 inches (2.5 to 5.0 cm) from your mouth.

 - 3 The microphone remains active for the hot mic time specified in your radio's codeplug programming.

- 4 To exit Emergency Call, press and hold the preprogrammed **Emergency** button.
Turning off the radio also cancels the emergency state.
-

Sending a Silent Emergency Alarm

This feature allows you to send an Emergency Alarm to the system without triggering any audio or visual indicators.

- 1 Press the preprogrammed **Emergency** button.
The display shows no changes, the LED does not light up, and you hear no tones. The silent emergency state continues until you perform the next step.
-

- 2 Perform one of the following actions:
 - Press and hold the preprogrammed **Emergency** button for about a second to exit the Silent Emergency Alarm mode.
 - Press and release the **PTT** button to exit the Silent Emergency Alarm mode and enter regular dispatch or Emergency Call mode.
-

Change of Channels during Emergency

For ALL Emergency transmissions, when changing channels:

- If the new channel is also preprogrammed for Emergency, you can change channels while in Emergency operation. The emergency alarm or call continues on the new channel.
- If the new channel is **not** preprogrammed for Emergency, the display shows `No emergency`, and you hear an invalid tone until you exit the Emergency state or change to a channel preprogrammed for Emergency.

Emergency Keep-Alive Feature

This feature, when enabled, prevents the radio from being turned off by using the **On/Off Control Knob** when the radio is in the Emergency state.

**NOTICE:**

The radio only exits the Emergency state using one of the ways mentioned in the previous sections.

See [Sending an Emergency Alarm on page 100](#), [Sending an Emergency Call \(Trunking Only\) on page 101](#), [Sending an Emergency Alarm with Emergency Call on page 102](#), or [Sending a Silent Emergency Alarm on page 104](#).

Emergency Find Me

The Emergency Find Me (EFM) feature is an additional emergency feature providing information to nearby radios, utilizing the Bluetooth Low Energy (BT-LE) transmission from a radio. In an emergency situation, when the user presses the pre-programmed Emergency button, there will be periodic EFM beacon transmitted from the radio along with the other existing emergency activities. The radios which are near to the transmitting radio and are capable of receiving BT-LE signals would receive the beacon transmission. The range of EFM beacon depends on the environment in which the radios are located.

Check with your dealer or system administrator for more information on the programming of this feature.

Sending and Receiving Emergency Find Me Beacon

- 1 Press the pre-programmed **Emergency** button to transmit the EFM beacon.

The receiving radio displays `Beacon RX` and the transmitting radio Contact ID or alias on the radio display. In the case of multiple radios transmitting at one time, the receiving radio displays `Multiple Beacon RX`.

-
- 2 Press the menu `Bcon`. The receiving radio displays the transmitting radios Contact ID and one of the following RSSI values based on the signal strength received:
 - RSSI-Excellent
 - RSSI-Good
 - RSSI-Fair
 - RSSI-Poor

**NOTICE:**

RSSI-Poor will be shown if the distance between transmit radio and receive radios are more than 8 to 10 meters in an open environment.

Fireground

The portable Fireground Communications System is designed for deployment at an incident scene. It consists of central components:

- Your APX portable radios
- Incident Management Software
- Command Terminal
- Radio Frequency (RF) Modem (Conventional Only)
- Control Channel Radio (Trunking)
- Optional Data Radio (Trunking)
- Accountability Server (Trunking)
- DVRS (Optional)

These components provide on-scene and inbuilding radio coverage, and enhanced personnel accountability and monitoring.

The radio helps to indicate your presence on the scene if it is in the range of the Incident Commander command terminal, or trunking radio system.

Each Fireground Communication System radio automatically reports your radio ID on the commander mobile command terminal. Your name, riding position and sector are all can be configured to be seen at the Commander's command terminal.

If you have a critical situation, you can press the Emergency button which activates an alarm on the Incident Management Software at the command terminal.

The command terminal receives the following status updates from your radio:

- Powering up or down the radio
- Automatic response to Polling
- Response to Evacuation commands
- Pressing the **PTT** button to make voice transmission
- Sending an Emergency Alarm and Call
- Entering or Exiting a Trunking Talkgroup

Entering Fireground Zone Channel (Conventional)

- 1 Upon powering up, one of the following scenarios occurs:
 - If the Fireground Zone Channel is set as default, you hear the gurgle tone and the radio displays the home screen. You are in Fireground zone channel.
 - If the Fireground Zone Channel is set as default, but you hear a short, low-pitched tone, the display shows **Reg failed** to indicate that the command terminal does not respond to Fireground Zone Channel. Get a qualified technician for assistance.
 - If your home channel is not Fireground Zone Channel, toggle or change the radio zone channel to Fireground Zone Channel.

If you are entering Fireground Trunking Talkgroup, upon powering up, ensure that the Fireground Trunking Talkgroup is selected. The subscriber unit automatically appears on the Incident Commander's terminal.

- 2 Listen for a transmission. Adjust the **Volume Control Knob** if necessary.
-
- 3 Perform one of the following actions:
 - Press and hold the preprogrammed **Volume Set** button to hear the volume set tone. Adjust the **Volume Control Knob** if necessary. Release the **Volume Set** button.
 - At the desired Fireground zone and channel, press the preprogrammed **Monitor** button and listen for activity. Adjust the **Volume Control Knob** if necessary.
 - If your radio is working in Fireground Zone Channel, proceed to next step.
-
- 4 Press and hold the **PTT** button to transmit. The LED lights up solid red while transmitting. Talk into the microphone clearly if needed.
-
- 5 Release the **PTT** button to receive.
You hear a Transmit End Tone.
-

Sending Evacuation Tone

This feature enables the evacuation tone to be heard on the transmitting radio and on any radio that is able to receive the tone instruction.

Press and hold the **PTT** button and then short press the **Top (Orange)** button.

Once the tone begins to sound, if the orange button is released the tone continues to alarm on all radios within the talkgroup, until the **PTT** button is released.

**NOTICE:**

Radio does not transmit evacuation tone if the radio is in secure mode.

Responding to Evacuation Indicator

The Incident Commander can trigger one of sixteen Tactical Alerts from the Command Terminal. These alerts can target individuals or groups of users within the Fireground Communication System. The ergonomic (visual and audible) response for the Tactical Alerts can be customized.

Your radio sounds the audible response at the profile maximum alert tone volume level. The display shows the configurable programmed alert text and intelligent lighting.

Perform one of the following actions:

- Press the radio **Top Side** button.
- Press the RSM **Side Button 1** if the radio is connected to RSM.
- Press the **PTT** button. **PTT** button must be configured in CPS to enable this function.

The radio cancels the indications, a tone sounds and the radio sends an acknowledgment to the command terminal.

**NOTICE:**

Move the **Volume Control Knob** to adjust the volume of the audible alert from full volume.

Tactical Public Safety (TPS) (Conventional Only)

TPS enables the user of a group to identify the start and the end of a transmission by displaying the caller name or ID on the radio display.

Using TPS Normal Transmission

At TPS Zone Channel, perform one of the following actions:

- Press **PTT** button to transmit. Talk clearly into the microphone. Release **PTT** button to listen.
- Receive and listen to call, the radio displays the caller's name or ID.

Using TPS Emergency Transmission

The following are two important alert tones designed for this feature.

Emergency Beacon

During Emergency if the TPS radio user pushes the **Emergency** button, the radio sounds a Beacon at the maximum volume of the radio at radio's internal speaker

and it is not adjustable. This beacon goes to silent when user presses the **PTT** button for voice transmission.

Emergency Call De-Key Sidetone

The radio sounds an alert tone to remind radio user that the Emergency Mode is still active after user releases the **PTT** button for an Emergency call transmission. The volume of loudness depends on the maximum tone at your radio profile.

- 1 Press the **Emergency** button to enter Emergency Mode.

You hear the Emergency Beacon.

- 2 Press **PTT** button to make an Emergency Call.

- 3 Release to listen.

You hear Emergency Call De-Key Sidetone. After a short pause, you hear Emergency Beacon.

- 4 Long press **Emergency** button to exit Emergency mode and cancel Emergency Beacon.

Man Down

Man Down condition is determined based upon the radio tilt angle or a combination of radio tilt angle and the lack of radio motion.

Man Down feature is an alternate way to activate the Emergency feature if Emergency has been programmed in your radio.



NOTICE:

This feature could be preprogrammed for all channels that support Emergency feature or could be preprogrammed specifically to a zone and channel which has Emergency feature. Consult your agent or qualified technician for more details.

Your radio automatically activates Emergency Alarm or Call when the radio achieves or passes a tilt angle threshold or a combination of the angle threshold and radio motion below the motion sensitivity level, depending upon how the radio is programmed. The radio must stay in this condition for a preprogrammed amount of time before the Emergency Alarm or Call is activated.



NOTICE:

It is recommended that an Emergency button is preprogrammed in order to allow the user to exit the emergency condition.

The Man Down feature provides a **Clear** function to the user. After a Man Down condition has been detected, the user can press a preprogrammed **Clear** button or preprogrammed **Menu Select** button to cancel the Man Down condition. The radio remains in the Man Down state without triggering an emergency condition until the radio is moved out of the Man Down state, at which point Man Down functionality resumes.

The Man Down feature has three phases:

- 1 The radio senses the Man Down condition and Pre-Alert Timer is initiated.
- 2 Man Down condition continues for the time duration defined in the Pre-Alert Timer field. At the end of this time, the radio alerts the user on the Man Down status with an audible alert tone and `Man-Down` text on the screen. The Post-Alert Timer also initiates at this point.
- 3 Man Down condition continues for the time duration defined in the Post-Alert Timer field. Once the timer expires, the Emergency alarm is transmitted. The Man Down Clear function is used in this phase to cancel the Man Down condition.

The following scenarios affect the timers:

- Pressing the **PTT** button suspends the Man Down timers; releasing the **PTT** button re-initiates the Pre-Alert Timer.
- Pressing other buttons on the radio does not impact these timers.
- Repositioning the radio exits the Man Down feature, which stops and resets the timers.
- Pressing a preprogrammed **Clear** button or pressing a **Menu Select** button preprogrammed for **Clear** stops and resets the timers. The timers do not restart until the radio is repositioned.

**NOTICE:**

Emergency must be set up for this feature to operate. For details on operating the Emergency alerts, please see [Emergency Operation on page 99](#).

If the radio is preprogrammed to horizontal only, it must be worn in a vertical position otherwise the Man Down alert may be inadvertently triggered.

When the radio is programmed with Man Down feature, special care is required when charging the radio with a wall mounted charger. See [Proper Ways to Handle the Radio](#) for details.

Pre-Alert Timer

This timer sets the amount of time that a Man Down condition must be present before the radio-user is warned of the Man Down condition.

When the radio detects that it has returned to the vertical position or when the radio detects motion, the Pre-Alert timer stops and is reset.

The Pre-Alert timer reinitiates when the radio detects it is in the horizontal position or motionless again.

Post-Alert Timer

This timer sets the amount of time the radio needs to remain in the Man Down condition before the Emergency alarm is transmitted. When the Post-Alert Timer is initiated, the radio alerts the user with an audible tone and displays the `Man-Down` text.

See [Exiting Man Down Feature on page 113](#) to exit Man Down feature.

Radio Alerts When Man Down Feature is Triggered

The Man Down alert tone volume is directly related to the radio speaker volume. Ensure that the radio speaker volume is loud enough so that the user does not miss the Post-Alert tone.



NOTICE:

If the radio is programmed with Silent Emergency, the radio inhibits the alert tone and visual alert associated with the emergency feature.

If the radio is programmed in Surveillance Mode, the radio inhibits all tones and lights on the radio including the Man Down tones.

Triggering Emergency

When the user does not clear the Man Down condition and the Post-Alert Timer comes to an end, Emergency Alarm or call is triggered. The radio sends emergency message to units within the same Talkgroup. The radio also sends ID number and GPS coordinates to dispatcher if these features are enabled. User can exit Emergency following the Emergency procedure. See [Emergency Operation on page 99](#) for details.



NOTICE:

At this point the Man Down features is complete. Use normal Emergency procedures to cancel Emergency transmissions.

Radio Alerts When Man Down Enhanced is Triggered



NOTICE:

This feature is to be preprogrammed specifically to a zone and channel which supports Emergency feature.

The volume and repetition duration of Man Down Enhanced alert tone could be customized and preprogrammed to suite the required situation.

Consult your agent or qualified technician for more details.

When the radio initiates Man Down Enhanced, you hear the Critical Man Down Continuous alert tone from the radio speaker. The volume of this tone is set to the louder of the preprogrammed minimum level or the current radio speaker level. This acts as a beacon to find the radio.

**NOTICE:**

If the radio is programmed with Silent Emergency, the radio inhibits the alert tone and visual alert associated with the emergency feature.

If the radio is programmed in Surveillance Mode, the alert tone can be heard from the radio speaker.

Once the alert tone is active, changing to another channel with different setup triggers a different response from the radio as described next.

- The alert tone is inhibited when you change to a channel without Emergency feature.
- The alert tone is inhibited when you change to a channel with Emergency but no Man Down feature.
- The current alert tone is inhibited and is replaced with a different alert tone when you change to a channel with Emergency and different Man Down configuration.
- The alert tone continues when you change to a channel with Emergency and similar Man Down configuration.

Exiting Man Down Feature

If you are not in a real Man Down situation, you should exit the Man Down feature and prevent emergency from going off with the following operation.

Perform one of the following actions:

- Repositioning the radio or shaking the radio (when motion sensitivity is enabled).
- Press the preprogrammed **Man Down Clear** button to exit.
- Press the **Menu Select** button below **CLR** to exit.

Re-Initiating Man Down

After exiting the Emergency Operation when the radio is still in Man Down condition (tilted achieving threshold angle or motionless), user must first exit Man Down condition to then reinitiate the Man Down feature.

Return the radio to the vertical position or shake the radio (when motion sensitivity is enabled).

Testing the Man Down Feature

Enable the Emergency feature with Silent Alarm disabled, but not in Surveillance Mode before running this test on the radio.

- 1 Turn the radio on and place in the vertical position, for at least 5 seconds.

- 2 Lay the radio down in the horizontal position.

- 3 Wait for alert tone.

One of the following scenarios occurs:

- The radio alerts with audible tone and displays **Man-Down**.
- If no tone is heard, make sure that the Man Down feature is enabled on your radio. If Man Down feature was not enabled, please enable it and repeat [step 1](#) to [step 3](#).
- If the Man Down feature is enabled and no tone is heard, send the radio to a qualified technician.

Automatic Registration Service (ARS)

This feature provides an automated data application registration for the radio. When you turn on the radio, the device automatically registers with the server.

Data applications within the fixed network can determine the presence of a device on the system and send data to the device. For example: Text Messaging Service (TMS).

The ARS for the radio consists of two modes:

- ARS Server Mode (default mode)
- ARS Non-Server Mode



NOTICE:

The default ARS mode can be changed by a qualified radio technician using the radio's programming software.

Selecting or Changing the ARS Mode

The following methods are options on how to select or change the ARS Mode. The result of all the methods is the

same. You can use the options interchangeably depending on your preference and the programmed functions.

- Selecting or Changing the ARS mode using the **16-Position Select** knob:
 - a. Once the zone you want is displayed, turn the preprogrammed **16-Position Select** knob to the desired mode.
- Selecting or Changing the ARS mode using the radio menu:
 - a. ◀ or ▶ to Chan .
 - b. Press the **Menu Select** button directly below Chan .
The display shows the current channel name.
 - c. ▲ or ▼ to the required channel or mode.
One of the following scenarios occur:
 - In ARS Server Mode, the display shows the zone and ARS server channel.
 - In ARS Non-Server Mode, the display shows the zone and ARS non-server channel.

- If the channel or mode selected is unprogrammed, the display shows Unprogrammed. Repeat this step.

d. Press Sel to confirm the displayed channel.

User Login Feature

This feature allows you as the user to be associated with the radio. With this association, every data application (Example: Text Messaging Service) takes on a friendly username.

You can still send text messages without logging in as a user. The user login feature only enables the recipient of your message to identify you as the sender by assigning a username to your message.



NOTICE:

A predefined username that is set more than the maximum allowed characters is an invalid name.

Logging In as a User

- 1 Perform one of the following actions:
 - Press the preprogrammed **User Login** button.

- **◀** or **▶** to `User` and press the **Menu Select** button directly below `User`.

The display shows the User Login screen.

2 Perform one of the following actions:

- **▲** or **▼** to `[ID Entry]` and press the **Menu Select** button directly below `Edit` to enter ID. A blinking cursor appears on the screen. Use the **keypad** to type or edit a user name. Press the **Menu Select** button directly below `Ok` to submit.
- **▲** or **▼** to scroll through the list of predefined user names. Press the **Menu Select** button directly below `Sel` to select the predefined user name.
- Press and hold **▲** or **▼** to scroll through the list of predefined user names at a fast scroll rate. Press the **Menu Select** button directly below `Sel` to select the predefined user name.

If the ID is invalid, the display shows momentary `Invalid ID`.

3 Enter your Personal Identification Number (PIN) number.

4 Press the **Menu Select** button directly below `Logn`.

One of the following scenarios occurs:

- In ARS Server Mode, the display shows the User Login Indicator icon, the ID, and `In progress`, with `Cncl`.
- In ARS Non-Server Mode, the display shows the User Login Indicator icon, the ID, and `Logged in`, with `Logt` and `Exit`.
- In non-ARS enabled mode, the display shows `Offline`, with `Logt` and `Exit`.

One of the following scenarios occurs:

- If the user name is invalid, login fails and the user login failure indicator (IP indicator) icon blinks. The display also shows momentary `Login failed`.
- If the PIN is invalid, login fails and the user login failure indicator (IP indicator) icon blinks. The display also shows momentary `Login failed`.
- Wait for the logged in confirmation screen. If the login process is successful, the display shows the successful user login indicator (IP indicator) icon and `Logged in`, with `Logt` and `Exit`.

**NOTICE:**

To cancel the login process and return to the initial user login screen, press the **Menu Select** button directly below **Cnc1**.

- Select **Yes** to clear all your private data. The display shows momentary **Private data cleared**.
- Select **No** to keep your private data.

Logging Out

When you have logged in or you are using Offline mode, you can log out.

**NOTICE:**

Private data refers to all messages in the text messaging **Inbox**, **Draft**, and **Sent** folder. The next user is able to access the **Inbox**, **Draft**, and **Sent** messages if private data is not deleted.

- 1 Press the **Menu Select** button directly below **Logt**.

One of the following scenarios will occur:

- The display shows **Clear private data?**. Proceed to the next step.
- If the Delete Messages On Session End feature is enabled, the radio clears the private data and returns to **User Login** screen.

- 2 Perform one of the following actions:

Text Messaging Service (TMS)

This feature allows you to quickly send and receive messages and run database queries directly from your radios. The maximum length of characters for a text message is 200.

The types of text messages available:

- A new text message (free form message).
- A predefined message (quick text message).
- An edited quick text message.
- A query (ASTRO 25 Advanced Messaging Solution).

**NOTICE:**

Query is only supported within ASTRO 25 Advanced Messaging Solution. See [Two-Factor Authentication on page 130](#) and [ASTRO 25 Advanced Messaging Solution on page 129](#) for details.

The main menu consists of the following options:

- Inbox
- Compose
- Drafts
- Sent



NOTICE:



See [Status Icons on page 48](#) for more information on the TMS icons and [TMS Menu Options on page 54](#) for more information on each menu option.

Accessing the Messaging Features

- 1 Perform one of the following actions:
 - Press the **Data Feature** button or the preprogrammed **TMS Feature** button to access the TMS feature screen.
 - Press and hold the **Data Feature** button or the preprogrammed **TMS Feature** button to access the Inbox.
 - Follow the procedure described next to access this feature using the radio menu.

- 2  or  to TMS.

- 3 Press the **Menu Select** button directly below TMS to access the TMS feature screen.

- 4  or  to scroll through the main menu options.



NOTICE:

The radio automatically exits the feature, if the feature inactivity timer is enabled, when the radio is left idle and the timer expires. You will hear the Menu Inactive Exit Tone upon feature exit.

Press the **Menu Select** button directly below **Back** at any time to return to the previous screen.

Composing and Sending a New Text Message

During the uppercase and lowercase mode, multi-tapping the keys only scrolls through the letters. For example, **A**->**B**->**C**, **a**->**b**->**c**.

During the numeric mode, except for , pressing the keypad only enters the numeric digits. Subsequent presses

of the same key inserts the same digit to the text message (no multi-tap).

1 ◀ or ▶ to TMS.

2 Press the **Menu Select** button directly below TMS to access the TMS feature screen.

3 Perform one of the following actions:

- ▲ or ▼ to Compose and press the **Menu Select** button directly below Sel.
 - Press the **Menu Select** button directly below Exit to return to the **Home** screen.
-

4 ▲ or ▼ to Text Message and press the **Menu Select** button directly below Sel to compose a new message.

A blinking cursor appears on the Compose screen.

5 Use the keypad to type or edit your message.

6 Press the **Menu Select** button directly below Optn once the message is composed.

7 ▲ or ▼ to Send Message and press the **Menu Select** button directly below Sel .

8 Perform one of the following actions:

- ▲ or ▼ to scroll through the address list and select the required address.
 - ▲ or ▼ to [Other Recpnt] and press the **Menu Select** button below Edit. When a blinking cursor appears in the Enter Address screen, use the **keypad** to type the address entry.
-

9 Press the **Menu Select** button directly below Send or press the PTT button to send the message.

The display shows the Send Message screen and Sending msg.

If the message is sent, you hear a tone and the display shows Msg sent.

If the message is not sent, you hear a low tone, the display shows Send failed and returns to the main TMS screen.

**NOTICE:**

You can append a priority status and/or a request reply to your message. See [Priority Status and Request Reply of a New Text Message on page 121](#) for more information. You can also select the *Save to Drafts* option to save your message in the Drafts folder to send it at a later time. See [Accessing the Drafts Folder on page 126](#) for more information.

Sending a Quick Text Message

Quick Text messages are messages that are predefined and usually consist of messages that are used most frequently.

Each Quick Text message or Query has a maximum length of 50 characters. You can select the required text from the Quick Text or Query.

- 1 Perform one of the following actions:
 - To access this feature using the preprogrammed button, press the preprogrammed **Quick Text** button and proceed to [step 4](#).

- To access this feature using the menu, proceed to the next step.

-
- 2 ◀ or ▶ to **TMS** and press the **Menu Select** button directly below **TMS** to access the TMS feature screen.
-
- 3 Perform one of the following actions:
 - ▲ or ▼ to **Compose** and press the **Menu Select** button directly below **Sel**.
 - Press the **Menu Select** button directly below **Exit** to return to the Home screen.
-
- 4 ▲ or ▼ to **Quick Text** and press the **Menu Select** button directly below **Sel** for a predefined message.
-
- 5 ▲ or ▼ to scroll through the list of messages and press the **Menu Select** button directly below **Sel** to select the required message.

The message appears on the **Compose** screen, with a blinking cursor at the end of it. Use the keypad to edit the message, if required.
-
- 6 Press the **Menu Select** button directly below **Optn**.
-

- 7 ▲ or ▼ to `Send Message` and press the **Menu Select** button directly below `Sel` .
-

- 8 Perform one of the following actions:

- ▲ or ▼ to scroll through the address list and select the required address.
 - ▲ or ▼ to `[Other Recpnt]` and press the **Menu Select** button below `Edit`. When a blinking cursor appears on the `Enter Address` screen. Use the keypad to type the address entry.
-

- 9 Press the **Menu Select** button directly below `Send` or press the PTT button to send the message.

The display shows the `Send Message` screen and `Sending msg.`

If the message is sent, you hear a tone and the display shows `Msg sent.`

If the message is not sent, you hear a low tone, the display shows `Send failed` and returns to the main TMS screen.



NOTICE:

You can append a priority status and/or a request reply to your message. See [Priority Status and Request Reply of a New Text Message](#) on page 121 for more information.

Priority Status and Request Reply of a New Text Message

Before sending your message, you can append a priority status and/or a request reply to your message.

Appending a Priority Status to a Text Message

Ensure that an outgoing message is composed to allow you to perform this procedure. See [Composing and Sending a New Text Message](#) on page 118 for more information.

**NOTICE:**

The Priority Status icon on a message does not imply that the message gets higher priority over the other messages when it is being transmitted. It is just an indication that can be embedded into a message to let the receiver know that the message is important.

- 1 Press the **Menu Select** button directly below `Optn`.

- 2 ▲ or ▼ to `Mark Important` and press the **Menu Select** button directly below `Se1` to indicate the message is important.

The priority status icon appears beside the normal message icon on the label bar.

Removing a Priority Status from a Text Message

Ensure there is an outgoing message composed to allow you to perform this procedure. See [Composing and Sending a New Text Message on page 118](#) for more information.

- 1 Press the **Menu Select** button directly below `Optn`.

- 2 ▲ or ▼ to `Mark as Normal` and press the **Menu Select** button directly below `Se1` to remove the priority status from the message.

The display shows the normal message icon on the label bar.

Appending a Request Reply to a Text Message

Ensure that an outgoing message is composed to allow you to perform this procedure. See [Composing and Sending a New Text Message on page 118](#) for more information

- 1 Press the **Menu Select** button directly below `Optn`.

- 2 ▲ or ▼ to `Req Reply` and press the **Menu Select** button directly below `Se1` to request for a reply.

The request reply icon appears beside the normal message icon on the label bar.

Removing a Request Reply from a Text Message

Ensure that an outgoing message is composed to allow you to perform this procedure. See [Composing and Sending a New Text Message on page 118](#) for more information.

- 1 Press the **Menu Select** button directly below **Optn**.

- 2 ▲ or ▼ to **No Req Reply** and press the **Menu Select** button directly below **Se1** to remove the priority status from the message.

The display shows the normal message icon on the label bar.

Appending a Priority Status and a Reply Request to a Text Message

Ensure that an outgoing message is composed to allow you to perform this procedure. See [Composing and Sending a New Text Message on page 118](#) for more information.

- 1 Press the **Menu Select** button directly below **Optn**.

- 2 ▲ or ▼ to **Mark Important** and press the **Menu Select** button directly below **Se1** to indicate the message is important.

- 3 ▲ or ▼ to **Req Reply** and press the **Menu Select** button directly below **Se1** to request for a reply.

The priority status and request reply icons appear beside the normal message icon on the label bar.

Removing a Priority Status and a Reply Request from a Text Message

Ensure that a outgoing message is composed to allow you to perform this procedure. See [Composing and Sending a New Text Message on page 118](#) for more information.

- 1 Press the **Menu Select** button directly below **Optn**.

- 2 ▲ or ▼ to **Mark Important** and press the **Menu Select** button directly below **Se1** to remove the priority status icon.

- 3 ▲ or ▼ to No Req Reply and press the **Menu Select** button directly below Sel to remove the reply status icon.
-

The display shows the normal message icon on the label bar.

Receiving a Text Message



NOTICE:

When you receive a message that is flagged with the Request Reply icon, you must manually respond to the sender that you have received the message. The system will not automatically send a notification to acknowledge that the message was received.

Do one of the following to receive a text message. You can use the options interchangeably depending on your preference and the programmed functions.

- Receiving a text message using the **Data Feature** button or the **TMS Feature** button:
When you receive a message, press and hold the preprogrammed **Data Feature** button or the **TMS Feature** button to access the Inbox.
- Receiving a text message using the radio menu:

When the new message icon appears and the display shows momentary New msg, press the **Menu Select** button directly below TMS to access the Inbox.

The display shows a list of aliases or IDs, with the sender of the latest received message on top.

Viewing a Text Message from the Inbox

The Inbox can hold up to 30 messages.



NOTICE:

▲ or ▼ to read the message if the content fills more than one screen.

- 1 Perform one of the following actions:
 - Press the preprogrammed **Data Feature** button or the **TMS Feature** button to access the TMS feature screen. ▲ or ▼ to Inbox and press the **Menu Select** button below Sel .
 - Press and hold the preprogrammed **Data Feature** button or the **TMS Feature** button to access the Inbox.
 - ◀ or ▶ to TMS and press the **Menu Select** button directly below TMS to access the TMS feature

screen. ▲ or ▼ to Inbox and press the **Menu Select** button below `Se1`.

The display shows a list of aliases or IDs, with the sender of the latest received message on top.

-
- 2 ▲ or ▼ to the required aliases or ID and press the **Menu Select** button below `Se1` to view the message.

While on the view message screen, press the **Menu Select** button directly below `Optn`, `Del`, or `Back` to access the option.

- Select `Optn` to configure the message settings.
- Select `Del` to delete the message.
- Select `Back` to return to the previous screen.



NOTICE:

The icon at the top right corner of the screen indicates the status of the message. See [Text Messaging Service \(TMS\) Indicators on page 53](#) for more information.

Replying to a Received Text Message



NOTICE:

The original date and time stamp, address, and message content is automatically appended to the reply message.

-
- 1 ▲ or ▼ to the required aliases or ID and press the **Menu Select** button below `Se1` to view the message.
-
- 2 Press the **Menu Select** button directly below `Rply` to reply to a message.
-
- 3 Perform one of the following actions:
 - ▲ or ▼ to `Text Message` and press the **Menu Select** button directly below `Se1`.
 - ▲ or ▼ to `Quick Text` and press the **Menu Select** button directly below `Se1` for a predefined message.
 - ▲ or ▼ to scroll through the list of predefined messages and press the **Menu Select** button directly below `Se1` to select the required message.

One of the following scenarios occurs:

- A blinking cursor appears on the `Compose` screen.
- The predefined message appears on the `Compose` screen, with a blinking cursor at the end of it.

4 Use the keypad to type or edit your message.

5 Press the **Menu Select** button directly below `Optn` once you have completed the message.

6 `▲` or `▼` to `Send Message` and press the **Menu Select** button directly below `Se1` to send the message.

The display shows the `Send Message` screen and `Sending msg.`



NOTICE:

Press the **Menu Select** button directly below `Back` at any time to return to the previous screen.

You can append a priority status and/or a request reply to your message. See [Priority Status and Request Reply of a New Text Message on page 121](#) for more information.

Accessing the Drafts Folder

This folder stores the messages that were saved previously. The Drafts folder can hold up to 10 messages. The oldest draft in the folder is deleted when the 11th message comes in.

1 `◀` or `▶` to `TMS`.

2 Press the **Menu Select** button directly below `TMS` to access the `TMS` feature screen.

3 `▲` or `▼` to `Drafts` and press the **Menu Select** button below `Se1`.

The display shows a list of drafts, with the latest text message drafted on top.

4 `▲` or `▼` to the required text message and press the **Menu Select** button below `Se1` to view the message.

Press the **Menu Select** button directly below `Edit`, `Del`, or `Back` to access the option.

- Select `Edit` to edit the message before sending it.
- Select `Del` to delete the message.

- Select **Back** to return to the previous screen.
-

Sent Text Messages

Once a message is sent to another radio, it is saved in the Sent folder. The most recent sent text message is always added to the top of the Sent list.

The Sent folder is capable of storing a maximum of 10 messages. The oldest message in the folder is deleted when the 11th message comes in.

Viewing a Sent Text Message

- 1 Perform one of the following actions:
 - Press the preprogrammed **Data Feature** button or the **TMS Feature** button to access the TMS feature screen.
 - **▲** or **▼** to **TMS** and press the **Menu Select** button directly below **TMS** to access the TMS feature screen.
-

- 2 **▲** or **▼** to **Sent** and press the **Menu Select** button below **Se1**.

The display shows a list of aliases or IDs, with the recipient of latest sent message on top.

- 3 **▲** or **▼** to the required aliases or ID and press the **Menu Select** button below **Se1** to view the message.

While on the view message screen, press the **Menu Select** button directly below **Optn**, **Del**, or **Back** to access the option.

- Select **Optn** to configure the message settings.
- Select **Del** to delete the message.
- Select **Back** to return to the previous screen.



NOTICE:

The icon at the top right corner of the screen indicates the status of the message. See [Text Messaging Service \(TMS\) Indicators on page 53](#) for more information.

Sending a Sent Text Message

1 Press the **Menu Select** button directly below Optn while viewing the message.

2 ▲ or ▼ to Send Message and press the **Menu Select** button directly below Sel .

3 Perform one of the following actions:

- ▲ or ▼ to scroll through the address list and select the required address.
 - ▲ or ▼ to [Other Recpnt] and press the **Menu Select** button below Edit. When a blinking cursor appears in the Enter Address screen, use the **keypad** to type the address entry.
-

4 Press the **Menu Select** button below Send or the **PTT** button to send the message.

The display shows the Send Message screen and Sending msg.



NOTICE:

Press the **Menu Select** button directly below Back at any time to return to the previous screen.

You can append a priority status and/or a request reply to your message. See [Priority Status and Request Reply of a New Text Message on page 121](#) for more information.

Deleting a Text Message

1 From the **Inbox**, **Draft**, or **Sent** screen, ▲ or ▼ to scroll through the messages.

2 Press the **Menu Select** button directly below Del to delete the current message.

Deleting All Text Messages

1 Perform one of the following actions:

- Press the **Data Feature** button or the preprogrammed **TMS Feature** button to access the Messaging feature screen.

- ◀ or ▶ to TMS and press the **Menu Select** button directly below TMS to access the TMS feature screen.

-
- 2 ▲ or ▼ to Inbox or Sent then press the **Menu Select** button below CLR to select all messages in the selected folder.

The display shows Del all?.

-
- 3 Perform one of the following actions:

- Press the **Menu Select** button directly below Yes to delete all the messages in the selected folder.
- Press the **Menu Select** button directly below No to return to the main **TMS** feature screen.

ASTRO 25 Advanced Messaging Solution

The ASTRO 25 Advanced Messaging Solution allows you to quickly send and receive messages and run database queries directly from your data-enabled Motorola Solutions two-way radios. Federal mandate requires Two-Factor Authentication when querying Federal and State

databases. With this advance messaging solution you have the ability enable Two-Factor Authentication.

With Query and Two-Factor Authentication, you can use a secure system log on to initiate and receive key information on people, vehicles, and properties when doing the regular security patrol. You can access to local or external databases such as the National Crime Information Center (NCIC), for "Hot Hits" on priors and warrants. Query and Two-Factor Authentication has Criminal Justice Information Services (CJIS) security compliance for queries.

With this Advanced Messaging Solution, ARS functionality splits between two protocols:

- ARS for Device Registration
- New User Authentication for User Login

TMS functionality splits between two protocols:

- TMS for messaging
- New Service Advertisement for service availabilities

The radio with Two-Factor capabilities are backward compatible with the existing device registration system and TMS servers.

System Setup for ASTRO Advanced Messaging Solution

Your user name, unit ID and password all need to be provisioned in PremierOne™. Your user account in PremierOne needs to be linked to an RSA account specifying a token to be used with the Two-Factor passcode.

The radio caches the user name, unit ID and or Single Factor password in the codeplug, this allows the radio to automatically log in to use Single Factor authentication upon power up or mode change. The Two-Factor passcode is not stored in the codeplug. You can upgrade the Single Factor session to a Two- Factor session by entering the Two-Factor passcode only. After an interruption (for example mode change, DSR switch over, power loss) , the radio is capable of restoring the active session in its current state as long as the session is active in the server.

**NOTICE:**

Power down occurs when the user intentionally powers off the radio, power loss is when the battery dies or is removed from the unit.

Two-Factor Authentication

Two-Factor Authentication is an extension of existing ARS and TMS operation. This feature allows you to authenticate yourself with a username, unit ID, password, and passcode.

This feature allows the sender of a text message to address a specific user of the radio, so the message is delivered to the user, and not anyone else who may have been using the radio at the time.

This feature supports query authentication requirements so the query service knows which user originated a query.



You can still send text messages without logging in as a user. The user log in feature only enables the recipient of your message to identify you as the sender by assigning a username to your message.

**NOTICE:**

A predefined username that is set more than the maximum allowed characters is an invalid name.







Logging in using the Two-Factor Authentication

- 1 Perform one of the following actions:

- Press the preprogrammed **User Login** button.
-  or  to **User**, and press the **Menu Select** button directly below **User**.

The display shows the **User Login** screen.







2 Perform one of the following actions:

-  or  to [ID Entry] and press the **Menu Select** button directly below **Edit**. A blinking cursor appears. Use the **keypad** to type or edit a username. Press the **Menu Select** button directly below **Ok** to submit.
-  or  to scroll through the list of predefined usernames. Press the **Menu Select** button directly below **Sel** to select the predefined username.
- Press and hold  or  to scroll through the list of predefined usernames at a fast scroll rate. Press the **Menu Select** button directly below **Sel** to select the predefined username.

If the selected predefined username has more than the maximum allowed characters, or an invalid

character in it, the display shows momentary Invalid ID.

3 For radio enabled with Unit ID, perform one of the following actions:

-  or  to [UnitID Entry] and press the **Menu Select** button directly below **Edit**. A blinking cursor appears. Use the **keypad** to type or edit a Unit ID. Press the **Menu Select** button directly below **Ok** to submit.
-  or  to scroll through the list of predefined Unit IDs. Press the **Menu Select** button directly below **Sel** to select the predefined Unit ID.
- Press and hold  or  to scroll through the list of predefined Unit IDs at a fast scroll rate. Press the **Menu Select** button directly below **Sel** to select the predefined Unit ID.

If the selected predefined Unit ID has more than the maximum allowed characters, or an invalid character in it, the display shows momentary Invalid UnitID.

4 Enter your password when you see a blinking cursor.

- 5 Press the **Menu Select** button directly below `Logn` or `Ok`.

If only one-factor is enabled, the display shows `1F logged` at the status. The login operation is complete.

If login fails, the display shows momentary `Login failed`. The display returns to **User Login** screen.

- 6 For radio enabled with two-factor login, enter your passcode when you see a blinking cursor.
-

- 7 Press the **Menu Select** button directly below `Logn`.
The display shows `In progress`.
-

If the login fails, the display shows momentary `2F psod failed`. Press the **Menu Select** button directly below `Psod` to re-enter passcode. If successful, the display shows **User Login** screen with `2F logged in status` to indicate Two-Factor Authentication complete.

Logging out of Two-Factor Authentication



NOTICE:

Private data refers to all messages in the text messaging **Inbox**, **Draft**, and **Sent** folder. The next user is able to access the **Inbox**, **Draft**, and **Sent** messages if private data is not deleted. Radio that is successfully logged in to the secured system receives advertisement from the server that the access to the data for query is enabled.

- 1 Press the **Menu Select** button directly below `Logt`.

One of the following scenarios occurs:

- The display shows `Clear private data?`.
 - If the Delete Messages On Session End feature is enabled, the display shows momentary `Private data cleared`.
-

- 2 Select **Yes** to clear all your private data or select **No** to keep your private data.

If you select **Yes**, the display shows momentary `Private data cleared`.

Sending a Query

This feature is available for radio users who have successfully logged in with the Two-Factor Authentication. Query is a special form of Quick Text marked with a flag that is replied or dispatched in normal TMS message. The query template needs to be configured in the quick test list of the CPS. You can choose from the quick text list, including queries if present.

You shall receive a service advertisement message to indicate the Query is available after you have successfully logged in the radio with a Two-Factor Authentication.



NOTICE:

The query server must be selected as the destination so that it can receive the query message and respond the query with text message. The query server must be an entry in the data user list in the CPS.

- 1 Perform one of the following actions:
 - To access this feature using the preprogrammed button, press the preprogrammed **TMS Query** button and proceed to [step 5](#).
 - To access this feature using the menu, proceed to the next step.
-

- 2 ◀ or ▶ to TMS and press the **Menu Select** button directly below TMS to access the TMS feature screen.
-
- 3 Perform one of the following actions:
 - ▲ or ▼ to Compose and press the **Menu Select** button directly below Sel.
 - Press the **Menu Select** button directly below Exit to return to the Home screen.
-
- 4 ▲ or ▼ to Query and press the **Menu Select** button directly below Sel for a predefined message.
-
- 5 ▲ or ▼ to scroll through the list of messages and press the **Menu Select** button directly below Sel to select the required message.
The message appears on the Compose screen, with a blinking cursor at the end of it.
-
- 6 Use the keypad to edit the message, if required.
-
- 7 Press the **Menu Select** button directly below Optn.
-

- 8 ▲ or ▼ to Send Message and press the **Menu Select** button directly below Sel.
-
- 9 Perform one of the following actions:
- ▲ or ▼ to scroll through the address list and highlight the required address.
 - ▲ or ▼ to [Other Recpnt] and press the **Menu Select** button below Edit. A blinking cursor appears on the Enter Address screen. Use the keypad to type the address entry.
-

- 10 Press the **Menu Select** button below Send or the **PTT** button to send the message.

The display shows the Send Message screen and Sending msg.

If the message is sent, you hear a tone and the display shows Msg sent.

If the message is not sent, you hear a low tone, the display shows Send failed and returns to the main TMS screen.



NOTICE:

The server responds to your query with the required report in text messages. You can append a priority status and/or a request reply to your message. See [Priority Status and Request Reply of a New Text Message on page 121](#) for more information.

Receiving a Query

The information requested is received in TMS format.

When you receive a query, you hear a unique, high-pitched chirp and the display shows the message icon flagged with "Priority". The display shows momentary New msg.

To access the **Inbox**, press and hold the **Data Feature** button or the preprogrammed **TMS Feature** button or press the **Menu Select** button directly below TMS.

The display shows a list of aliases or IDs, with the sender of the latest received message on top.

Secure Operations

Secure radio operation provides the highest commercially available level of voice security on both trunked and conventional channels.

Unlike other forms of security, Motorola Solutions digital encryption provides signaling that makes it virtually impossible for others to decode any part of an encrypted message.



NOTICE:

The user can automatically enter the encrypted environment by default without having to manually select or clear the secure transmission. This extended feature can only be enabled through CPS configuration.

Selecting Secure Transmissions

Turn the preprogrammed **Secure/Clear** switch to the secure position.

- If the selected channel is preprogrammed for clear-only operation, when you press the **PTT** button, you hear an invalid mode tone and the display shows `Clear TX only`.

- The radio does not transmit until you set the **Secure/Clear** switch to the clear position.
 - If the “Ignore **Secure/Clear** Switch when Strapped” programming option is enabled, the radio transmits without displaying any messages in the strapped mode of operation, regardless of the **Secure/Clear** switch setting. This option must be preprogrammed by a qualified radio technician.
 - The **Secure/Clear** switch only applies when the radio is transmitting.
-

Selecting Clear Transmissions

Turn the preprogrammed **Secure/Clear** switch to the clear position.

- If the selected channel is preprogrammed for secure-only operation, when you press the **PTT** button, you hear an invalid mode tone and the display shows `Secure TX only`.
- The radio does not transmit until you set the **Secure/ Clear** switch to the secure position.

- You can request to configure the radio to ignore the clear voice or insecured transmission when the radio is in secured transmission. Check with your agent for details.
 - If the “Ignore **Secure/Clear** Switch when Strapped” programming option is enabled, the radio transmits without displaying any messages in the strapped mode of operation, regardless of the **Secure/Clear** switch setting. This option must be preprogrammed by a qualified radio technician.
 - The **Secure/Clear** switch only applies when the radio is transmitting.
-

Managing Encryption

This chapter explains the encryption feature on your radio.

Loading an Encryption Key



NOTICE:

Refer to the key-variable loader (KVL) manual for equipment connections and setup.

1 Attach the KVL to your radio.

The display shows **Keyloading**, and all other radio functions, except for power down, backlight, and volume, are locked out.

2 Select the required keys and press the **Menu Select** button directly below **LOAD** on the KVL.

This loads the encryption keys into your radio.

When the key has been loaded successfully, one of the following scenarios occurs:

- You hear the radio sounds a short tone for single-key radios.
- You hear the radio sounds an alternating tone for multikey radios.

The KVL indicates that keyload is successful.

Multikey Feature

This feature allows the radio to be equipped with different encryption keys and supports the DES-OFB algorithm.

There are two types of encryption keys:

Conventional Multikey

The encryption keys are strapped on a one-per-channel basis, through CPS. In addition, you can have operator-selectable keys, operator-selectable keysets, and operator-selectable key erasure. If talkgroups are enabled in conventional, then the encryption keys are strapped to the talkgroups.

Trunked Multikey



If the radio is used for both conventional and trunked applications, strap the encryption keys for trunking on a per-talkgroup or announcement-group basis. In addition, a different key can be strapped to other features, such as dynamic regrouping, failsoft, or emergency talkgroup. You can have operator-selectable key erasure.

Selecting an Encryption Key

1  or  to Key.

2 Press the **Menu Select** button directly below Key.

The display shows the last user-selected and stored encryption key, and the available menu selections.

3  or  to scroll through the encryption keys or use the keypad to enter the number of the desired key.

4 Perform one of the following actions:

- Press the **Menu Select** button directly below Sel to save the newly selected key and return to the **Home** screen.
- Press , the **PTT** button, or the **Menu Select** button directly below Exit.



NOTICE:

When the selected key is erased, you hear a momentary keyfail tone and the display shows `Key fail`.

When the selected key is not allowed, you hear a momentary illegal key tone and the display shows `Illegal key`.



Selecting a Keyset

This feature allows you to select one or more groups of several encryption keys from among the available keys stored in the radio.



For example, you could have a group of three keys structured to one keyset, and another group of three

different keys structured to another keyset; by changing keysets, you would automatically switch from one set of keys to the other.

Every channel to which one of the original keys was tied now has the equivalent new key instead.

- 1  or  to **KSet** and press the **Menu Select** button directly below **KSet**.

The display shows the last user-selected and stored keyset, and the available keyset menu selections.

- 2  or  to scroll through the keysets or use the keypad to enter the number of the desired keyset.
-

- 3 Press the **Menu Select** button directly below **Sel** to save the newly selected keyset.

The radio exits keyset selection and returns to the **Home** screen.





NOTICE:



Press , the **PTT** button, or the **Exit** menu selection, or turn the **16-Position Select** knob to exit this menu at any time without changing the keyset selection.



Erasing the Selected Encryption Keys

This feature allows you to erase all or selected encryption keys.

Do one of the following to erase the selected encryption keys. You can use the options interchangeably depending on your preference and the programmed functions.

- Erasing the selected encryption keys using the radio menu:
 - a.  or  to **Eras** and press the **Menu Select** button directly below **Eras**.

The display shows the last user-selected and stored encryption key, and the available menu selections.
 - b.  or  to the desired encryption key or use the keypad to enter the number of the desired key.
 - c. Press the **Menu Select** button directly below **Optn**.

The display shows the available key erase options.
 - d.  or  to the required option and press the **Menu Select** button directly below **Sel**.

- e. Select `Erase all keys?` or `Erase single key?` by pressing the **Menu Select** button below `Yes` to erase the encryption key(s) in the radio.

You can return to the previous screen by pressing the **Menu Select** button below `No`.

- Erasing the single key in radios with the single-key option and erasing all keys in radios with the multikey option by using the preprogrammed **Top Side (Select)** button and **Top (Orange)** button:
 - a. Press and hold the **Top Side (Select)** button.
 - b. While holding **Top Side (Select)** button down, press the **Top (Orange)** button.

The display shows `Please wait`. When all the encryption keys have been erased, the display shows `All keys erased`.



NOTICE:

Do **not** press the **Top (Orange)** button before pressing the **Top Side (Select)** button, unless you are in an emergency situation as this sends an emergency alarm.

Requesting an Over-the-Air Rekey (ASTRO Conventional Only)

Ensure that the Unique Shadow Key (USK) is loaded into the radio with the key-variable loader (KVL) before the rekey request can be sent. Refer to your local key management supervisor for more information.

This feature, also known as OTAR, allows the dispatcher to reprogram the encryption keys in the radio remotely. The dispatcher performs the rekey operation upon receiving a rekey request from the user.

1 ◀ or ▶ to `Reky`.

2 Press the **Menu Select** button directly below `Reky`.

3 Perform one of the following actions:

- Press the **PTT** button to send the rekey request.
- Press the **PTT** button again, or the  or **Emergency** button, to exit the feature and transmit in normal mode.

If the rekey operation fails, you hear a bad-key tone and the display shows `Rekey fail`.

**NOTICE:**

The rekey operation failure indicates that your radio does not contain the USK.

MDC Over-the-Air Rekeying Page

This feature allows you to view or define MDC Over-the-Air Rekeying (OTAR) features. It is applied only when operating in secure encrypted mode and only for conventional communications. In addition to Rekey Requests, OTAR transmissions include Delayed Acknowledgements, and Power-up Acknowledgements.

Some of the options selected may also need to be set up at the Key Management Controller (KMC) site to work properly.

**NOTICE:**

This feature must be preprogrammed by a qualified radio technician. Check with your dealer or system administrator for more information.

Infinite UKEK Retention

This feature enables Unique Key Encryption Key (UKEK) to be permanently stored in the radio even when all the

encryption keys are erased. Without this UKEK key, the radio cannot be rekeyed over the air.

**NOTICE:**

This feature must be preprogrammed by a qualified radio technician. Check with your dealer or system administrator for more information.

Hear Clear

**NOTICE:**

This feature must be preprogrammed by a qualified radio technician. Check with your dealer or system administrator for more information.

There are two components of Hear Clear.

Companding

Reduces the channel noise, such as OTA transmission that is predominantly present in UHF2 and 900 MHz channel with the following features.

Compressor

Reduces the background noise flow and the speech signal at transmitting radio.

Expander

Expands the speech while the noise flow remains the same at receiving radio.

Random FM Noise Canceller (Flutter Fighter)

Reduces the unwanted effects of random FM noise pulses caused by channel fading under high Signal-to-Noise (S/N) conditions such as in a moving transportation. The fading effects, heard as audio pops and clicks, are canceled without affecting the desired audio signal.

The Random FM Noise Canceller operates only in receive mode.

Security

This chapter explains the radio security features.

Radio Lock

This feature changes your radio to a more robust security system that protects the use of the secure encryption keys.

If this feature is enabled in your radio by a qualified radio technician, when you turn the radio on, the display shows `Radio locked`.

Unlocking Your Radio

- 1 Enter your numeric password.

Secure-equipped radios – 6 to 8 characters.

Clear radios – 0 to 8 characters.

- 2 Perform one of the following actions:

- Press the **Menu Select** button directly below `Set` to enter the code.
- Press the **Menu Select** button directly below `Del` to delete any unwanted characters.
- Press the **Menu Select** button directly below `Cnc1` to exit the feature.

If the password is correct, the radio unlocks.

If the password is incorrect, the display show `Incorrect password` and the radio remains locked.



If you enter three incorrect passwords in a row, the display shows `Deadlock`. Turn the radio off and then on, and begin again at [step 1](#).

**IMPORTANT:**



For Secure Radios Only – After a total of 17 consecutive incorrect passwords (turning the radio off and on does not reset this number), the radio erases all of its encryption keys and shows **Deadlock**. See a qualified radio technician.

If you forget the password, enter ********* to erase all keys and revert the password in the radio back to the default password of 01234567.

Changing Your Password

- 1  or  to Pswd.

- 2 Press the **Menu Select** button directly below Pswd.
The display shows **Change Password** screen.

- 3  or  to Unlock Pswd.

- 4 Press the **Menu Select** button directly below Sel .

- 5 Enter the old password.

- 6 Press the **Menu Select** button directly below Ok .

- 7 Enter the new password.

- 8 Press the **Menu Select** button directly below Ok .

- 9 Re-enter the new password.

- 10 Press the **Menu Select** button directly below Ok .

The password is updated.

If the two passwords do not match, repeat [step 5](#) through [step 10](#).

**NOTICE:**

If you enter three incorrect old passwords, the radio exits the password feature. You cannot access this feature again until you turn the radio off and on.

Changing Your Tactical Inhibit Password

- 1  or  to Pswd.

2 Press the **Menu Select** button directly below `Pswd`.
The display shows **Change Password** screen.

3 ▲ or ▼ to `Tactical Inh Encode Pswd`.

4 Press the **Menu Select** button directly below `Sel`.

5 Enter the old password.

6 Press the **Menu Select** button directly below `Ok`.

7 Enter the new password.

8 Press the **Menu Select** button directly below `Ok`.

9 Re-enter the new password.

10 Press the **Menu Select** button directly below `Ok`.

The password is updated.

If the two passwords do not match, repeat [step 5](#) through [step 10](#).



NOTICE:

If you enter three incorrect passwords, the radio exits the password feature. You cannot access this feature again until you turn the radio off and on.

Enabling or Disabling the Radio Lock Feature (Secure Radios Only)

This feature allows you to enable or disable the radio lock feature. It is programmable by a qualified radio technician.

1 ◀ or ▶ to `Logf`.

2 Press the **Menu Select** button directly below `Logf`.

One of the following results occur:

- The display shows `Pswd enabled`, indicating that the radio lock feature is enabled.
- The display shows `Pswd disabled`, indicating that the radio lock feature is disabled.



Radio Stun and Kill

This chapter explains the radio stun and kill features.

Radio Stun

This feature allows you to stun another radio by sending an over the air command using the menu on your radio. This feature prevents an unauthorized user from using the radio. Once the radio is stunned, a password is required to re-activate the stunned radio.



Using Radio Stun

- 1  or  to Stun.

- 2 Press the **Menu Select** button directly below Stun.
The display shows Enter Password.

- 3 Use the **keypad** to enter your Tactical Inhibit Encode Password.

- 4 Press the **Menu Select** button directly below Ok .
The display shows radio Contact IDs.

- 5 Perform one of the following actions:
 -  or  to the required ID.
 - Press the **Menu Select** button directly below LNum to go to the last number dialed.
 - Use the **keypad** to enter the required ID.
 - Press the **Menu Select** button directly below Send to initiate command.

If the receiving radio does not have encryption key to decrypt the received command, your radio display shows Ack received.

If the receiving radio does not have encryption key to decrypt the received encrypted command, your radio display shows Decrypt failed.

If the receiving radio is powered off or already killed, your radio display shows No Acknowledgment.

Once the receiving radio received the command, its screen locked and request for password.



NOTICE:

To un-stun a radio, follow the procedure in [Unlocking Your Radio on page 141](#).

Radio Kill

This feature allows you to render your radio or another radio inoperable if the radio is misplaced or lost. When a radio is killed, the display turns blank and all functions of the radio are not usable.

The killed radio can only be recovered from KILL with a special device. Consult an authorized and qualified technician for details.

Using Remote Kill to Kill Another Radio

Remote Kill allows you to render another radio inoperable by sending an over the air command using the menu on your radio.

1 ◀ or ▶ to Kill.

2 Press the **Menu Select** button directly below Kill.
The display shows Enter Password.

3 Use the keypad to enter your Tactical Inhibit Encode Password.

4 Press the **Menu Select** button directly below Ok .
The display shows the radio Contact IDs.

- 5 Perform one of the following actions:
- ▲ or ▼ to the required ID.
 - Press the **Menu Select** button directly below LNum to go to the last number dialed.
 - Use the **keypad** to enter the required ID.
 - Press the **Menu Select** button directly below Send to initiate command.

If the receiving radio received the command, your radio display shows Ack received.

If the receiving radio does not have encryption key to decrypt the received encrypted command, your radio display shows Decrypt failed.

If the receiving radio is powered off or already killed, your radio display shows No Acknowledgment.

Once the receiving radio received the command, its screen turns blank, the killed radio is inoperable.

Using Direct Kill to Kill Your Own Radio

Direct Kill allows you to make your own radio inoperable.

Press and hold the **Top Side** button then press the **Orange** button until the display turns blank and becomes inoperable.

Radio Inhibit

This feature allows the system administrator to put a radio into a non-functional state when the radio is missing or in an unknown hand. The radio stays in this state regardless of power changes, for example, battery removal.



NOTICE:

If the radio has Inter-system roaming capability, the system administrator is able to put the radio into a non-functional state when missing radio roamed to another system.

The radio can only be uninhibited by receiving an uninhibit command from the system administrator or reprogram the radio through labtool or depot CPS only.

Global Positioning System/Global Navigation Satellite System

The Global Navigation System (GNSS) in the radio integrated the information from the Global Positioning System (GPS) and Global Navigation Satellite System (GLONASS) to determine the approximate geographical location of your radio. The geographical location is expressed as latitude and longitude or Military Grid Reference System (MGRS) format per request from customers.



NOTICE:

This feature is addressed as GPS across the manual as the naming convention of the buttons and strings remain the same as the legacy feature of GPS.

The availability and accuracy of this location information (and the amount of time that it takes to calculate it) varies depending on the environment in which you are using the GPS feature.

For example, GPS location fixes are difficult to obtain indoors, in covered locations, between high buildings, or in situations where you have not established a clear broad view of the sky.

Once GPS is enabled, the radio displays the GPS icon on the screen. The dispatcher can always request the system to determine the real-time location coordinates of the radio.

GPS Operation

The GPS technology uses radio signals from earth orbiting satellites to establish location coordinates. Therefore, maximizing your view of unobstructed sky is essential for optimum performance.

Where adequate signals from multiple satellites are not available (usually because you cannot establish a view of a wide area of the sky), the GPS feature of your radio will not work. Such situations include but are not limited to:

- Underground locations
- Inside buildings, trains, or covered vehicles
- Under any metal, or concrete roof, or structure
- Between tall buildings or under dense tree-cover
- In temperature extremes outside the operating limits of your radio

Even where location information can be calculated in such situations, it may take longer to do so, and your location estimate may not be as accurate. Therefore, in any

emergency situation, always report your location to your dispatcher.

Keep in mind that the accuracy of the location information and the time it takes to obtain it varies depending upon circumstances, particularly the ability to receive signals from an adequate number of satellites.



NOTICE:

Even where adequate signals from multiple satellites are available, your GPS feature only provides an approximate location, usually within 10 meters from your actual location, but sometimes farther away.

The satellites used by the GPS feature are controlled by the U.S. government and are subject to changes implemented in accordance with the Department of Defense GPS user policy and the Federal Radio Navigation Plan. These changes may affect the performance of the GPS feature on your radio.

GPS Performance Enhancement

Sometimes, the GPS feature may be unable to complete a location calculation successfully. You then see a message indicating that your radio cannot connect to enough visible satellites.

To maximize the ability of your radio to determine a fix, take note of the following guidelines:

- For your initial fix, hold the radio in the face position.
- Stay in the open. The GPS feature works best where there is nothing between your radio and the open sky.

The Outdoor Location Feature (Using GPS)

This feature allows you to determine your current location using a location menu, as well as your current distance and bearing in relation to another location. Radio location may be requested and reported over-the-air.

Your radio stores up to a maximum of 60 programmable location coordinates, also known as waypoints. When the memory is full, the next waypoints automatically replaces the oldest waypoints in the radio.

The radio also stores four preprogrammed waypoints. These coordinates cannot be deleted.

The following table shows the differences between programmable waypoints and preprogrammed waypoints.

Programmable Waypoints	Preprogrammed Waypoints
User-configurable location coordinates.	Fixed location coordinates: <ul style="list-style-type: none"> • Home • Emergency • Last Known Location • Destination
Only the alias is editable, not the coordinates.	The Home and Destination coordinates are editable.
Coordinates can be deleted one at a time, or all at once.	Coordinates cannot be deleted.



NOTICE:

The radio automatically exits the feature, if the feature inactivity timer is enabled. You hear the Menu Inactive Exit Tone upon feature exit.

Military Grid Reference System (MGRS) Coordinates

This feature can only be enabled through CPS configuration. When the MGRS coordinate is enabled, all location coordinates are displayed in MGRS format, including the editable locations in GPS.



Accessing the Outdoor Location Feature



NOTICE:

An **ON** radio menu may be present on the Location menu screen if it is preprogrammed by the dealer or system administrator.

Press the preprogrammed **GPS** button to toggle the Outdoor Location feature to on or follow the following procedure to access this feature using the radio menu.

- 1  or  to `Loc.`

- 2 Press the **Menu Select** button directly below `Loc.`
The display shows `Location off.`

- 3 Perform one of the following actions:
 - To obtain a location fix, press the **Menu Select** button directly below `On .`
 - Press the **Menu Select** button directly below `Optn. ▲` or `▼` to Turn On GPS and press the **Menu Select** button directly below `Sel.`

The front display shows the MGRS or latitude/longitude location, time, and date of the last successful location fix.

- 4 To obtain a new location fix, press the **Menu Select** button directly below `Rfsh.`

The top line temporarily displays `Please wait` while the new location is being determined. While the new location is being determined, the location signal can be a solid or blinking icon.

Once the location coordinates are fixed, the display shows the current location along with the UTC (Zulu) time and date that the location fix was obtained.





The location coordinates are updated automatically every 5 seconds while the location signal is present.



If the radio fails to get a location fix, the display shows `No service` and returns to the previous display.

- 5 To return to the **Home** screen, press , the **PTT** button, the preprogrammed **GPS** button or the **Menu Select** button directly below `Exit`.
-

Saving a Waypoint

Ensure that your radio shows the current location on the screen.

- 1 Press the **Menu Select** button directly below `Optn`.
-
- 2 Perform one of the following actions:
 -  or  to `Save as Waypt` and press the **Menu Select** button directly below `Sel`.
 -  or  to `Save as Home` and press the **Menu Select** button directly below `Sel` and proceed to [step 5](#).

-  or  to `Save as Dest.` and press the **Menu Select** button directly below `Sel` and proceed to [step 5](#).

A blinking cursor appears on the screen.

- 3 Use the **keypad** to edit the auto-generated waypoint, if required, or press the **Menu Select** button directly below `Cncl` to return to the Location main screen.
-
- 4 Press the **Menu Select** button directly below `Ok` once you are done.

One of the following scenarios occur:

 - The display shows `Current loc saved as <Waypoint name>`.
 - The display shows `Current loc saved as [Home]`.
 - The display shows `Current loc saved as [Destination]`.
-

- 5 To return to the Home screen, press , the **PTT** button, the preprogrammed **GPS** button or the **Menu Select** button directly below `Exit`.
-

Viewing a Saved Waypoint

Ensure your radio shows the current location on the screen.

1 Press the **Menu Select** button directly below `Optn.`

2 ▲ or ▼ to `Waypoints` and press the **Menu Select** button directly below `Sel.`

The display shows a list of waypoints.

3 Perform one of the following actions:

- ▲ or ▼ to scroll through the list.
 - ▲ or ▼ to select a waypoint to view the location information in full.
-

4 Press the **Menu Select** button directly below `Optn.`

5 To view the MGRS or latitude/longitude location, time and date of the selected waypoint, ▲ or ▼ to `View` and press the **Menu Select** button directly below `Sel.`

6 To return to the previous screen, press the **Menu Select** button directly below `Back.`, or to return to the

Home screen, press , the **PTT** button, or the preprogrammed **GPS** button.

Editing the Alias of a Waypoint

Ensure your radio shows the current location on the screen.

1 Press the **Menu Select** button directly below `Optn.`

2 ▲ or ▼ to `Waypoints` and press the **Menu Select** button directly below `Sel.`

The display shows a list of waypoints.

3 ▲ or ▼ to the required saved waypoint, and press the **Menu Select** button directly below `Optn.`

4 ▲ or ▼ to `Edit name` and press the **Menu Select** button directly below `Sel.`

A blinking cursor appears in the `Edit Name` screen.

5 Use the **keypad** to edit the alias.

6 Perform one of the following actions:

- Press the **Menu Select** button directly below `Ok` once you are done.
- Press the **Menu Select** button directly below `Cncl` to return to the Waypoints main screen.

7 The display shows `<Waypoint name> Updated` and the radio returns to the Waypoints main screen.

8 Perform one of the following actions:

- Press the **Menu Select** button directly below `Back` to return to the previous screen.
- Press , the **PTT** button, or the preprogrammed **GPS** button to return to the Home screen.

Editing the Coordinates of a Waypoint





NOTICE:

The user can only edit preprogrammed coordinates of Home and Destination.





Ensure your radio shows the current location on the screen.



1 Press the **Menu Select** button directly below `Optn.`

2  or  to `Waypoints` and press the **Menu Select** button directly below `Sel.`

The display shows a list of waypoints.

3 Perform one of the following actions:

-  or  to `[Home]` and press the **Menu Select** button directly below `Optn.`
-  or  to `[Destination]` and press the **Menu Select** button directly below `Optn.`

4  or  to `Edit location` and press the **Menu Select** button directly below `Sel.`

The first number blinks.

5 Utilize the following control buttons to select the number/coordinates if required, then press the **Menu Select** button directly below `Edit` to change the number/coordinates.

- Press  to move to the previous number/coordinates.

- Press **▶** to move to the next number/coordinates.

A blinking cursor appears in the `Edit Location` screen.

-
- 6** Utilize the following control buttons or menu to change the number/coordinates if required then press the **Menu Select** button directly below `Ok` once.
- Press **◀** to move one space to the left.
 - Press **▶** to move one space to the right.
 - Press the **Menu Select** button directly below `Del` to delete any unwanted characters.
 - Press the **Menu Select** button directly below `Cnc1` to return to the previous screen

-
- 7** Press the **Menu Select** button directly below `Ok` once complete setting up the new Home or Destination.

One of the following scenarios occurs:

- The display shows `[Home] Updated` and the radio returns to the Waypoints main screen.

- The display shows `[Destination] Updated` and the radio returns to the Waypoints main screen.

Deleting a Single Saved Waypoint

Ensure your radio shows the current location on the screen.

-
- 1** Press the **Menu Select** button directly below `Optn.`

-
- 2** **▲** or **▼** to `Waypoints` and press the **Menu Select** button directly below `Sel .`

The display shows a list of waypoints.

-
- 3** Perform one of the following actions:

- **▲** or **▼** to the required saved waypoint, and press the **Menu Select** button directly below `Optn.` **◀** or **▶** to `Edit name` and press the **Menu Select** button directly below `Del.`
- Press the **Menu Select** button directly below `Del.`

-
- 4** The display shows `Delete <Waypoint name>`
`Confirm?`
-

- 5 Press the **Menu Select** button directly below **Yes** to delete the waypoint or press the **Menu Select** button directly below **No** to return to the Waypoints main screen.
-

The display shows <Waypoint name>deleted.

Deleting All Saved Waypoints

Ensure your radio shows the current location on the screen.



NOTICE:

You cannot delete any of the preprogrammed waypoints.

- 1 Press the **Menu Select** button directly below **Optn.**
 - 2 ▲ or ▼ to **Waypoints** and press the **Menu Select** button directly below **Sel .**
-

The display shows a list of waypoints.

- 3 ▲ or ▼ to the required saved waypoint, and press the **Menu Select** button directly below **Optn.**
-

- 4 ▲ or ▼ to **Delete All** and press the **Menu Select** button directly below **Sel .**

The display shows **Delete All saved waypoints Confirm?**

- 5 Press the **Menu Select** button directly below **Yes** to delete all waypoints or press the **Menu Select** button directly below **No** to return to the Waypoints main screen.
-

The display shows **All saved waypoints deleted.**

Measuring the Distance and Bearing from a Saved Waypoint

Ensure your radio shows the current location on the screen.

- 1 Press the **Menu Select** button directly below **Optn.**
 - 2 ▲ or ▼ to **Dist frm here** and press the **Menu Select** button directly below **Sel .**
-

The display shows a list of waypoints.

- 3 ▲ or ▼ to the required waypoint and press the **Menu Select** button directly below **Set**.

The display shows the distance and bearing from the current to the selected coordinates.

Location Feature in Emergency Mode

When the Emergency feature is activated by pressing the emergency button, the radio exits the Location menu and returns to the Home (default) screen so that you can see which channel the emergency signal is going out on.

However, you may re-enter the Location menu while still in emergency mode, provided that Silent Emergency has not been activated.

If you have turned Location off using the **ON/OFF** menu key, it automatically turns back on when Emergency is activated.

If there is a solid location signal during Emergency, the current location and the location information received is saved as Emergency and Last Known Location waypoints, respectively.

Geofence (ASTRO 25 Trunking System)

Geofence is a virtual perimeter based on the GPS to define a geographical area on earth.

Check with your dealer or qualified technician to programme the geofence coordinates and actions.

When the radio enters the predefined Geofence area, your radio receives the Dynamic Regroup command from the system and immediately connects to a Dynamic Regroup talkgroup. The radio display shows the new selected Dynamic Regrouped talkgroup with green intelligent light for your attention.

On top of that, additional features are Voice Announcement of the new channel, and also direct content display of a text message to indicate that you are currently at Geofence area. Check with your nearest qualified technician on the requirements for these enhancements to work in Geofence.

Any new text messages received at Geofence shall have its content displayed immediately on the radio display.



NOTICE:

If the radio is set up in DVRS, only mobile radio is supported for this feature.

Entering the Geofence Area

The Voice Announcement and TMS display in this feature are optional. They must be configured to enable you to hear and see these indicators.

When the radio enters a Geofence area, the radio immediately sends a message `ACK` back to the system. The radio searches the current zone for the channel with same talkgroup assigned as the Dynamic Talkgroup and also with same system ID of current trunk system. Once matched, the radio display shows the first matched and connected channel alias.

If there is no channel with matching Talkgroup ID and trunk system ID, the radio display shows the channel alias of `<DYNAMIC talkgroup>`.

Once the radio is connected, you hear a dynamic regroup tone, the radio display shows `<DYNAMIC channel>` with temporary green color intelligent backlight and you hear a Voice Announcement.



NOTICE:

When the radio loses the GPS signal, the GPS icon blinks and the radio sounds two high-pitched tones repetitively to indicate that the GPS has failed to operate. The radio display shows the red intelligent light.

If the first matched channel is not configured with Voice Announcement, no Voice Announcement is played.

The system sends a message to your radio. The radio display shows a direct text message content without any user operation. This message indicates you are currently present in a Geofence area. This TMS remains open on the display until user presses exit/home to exit this screen.



NOTICE:

If there is another incoming text message before you exit the previous message, the message screen is refreshed to show the latest message.

The following procedure guides you to exit the text message received.

Press the **Menu Select** button below `Exit` or  to return to **Home** screen.

The other operations are the same as normal dynamic regroup command.

When the radio exits the Geofence area, your radio reverts to original channel or newly assigned talkgroup. The radio display shows the new channel together with Voice Announcement to indicate the changes. Voice Announcement of the new channel only works if that channel is configured with Voice Announcement.

Mission Critical Geofence

This feature allows the radio to use the GPS receiver to determine radio location at frequent intervals.

This feature also allows the radio to evaluate if the radio is within the Geofence area in real time.

Check with your dealer or qualified technician to programme the geofence coordinates and actions.

Entering Mission Critical Geofence

When the radio enters the predefined Geofence area, the radio displays `<Geofence Alias>` with intelligent backlight and the user hears a Voice Announcement. Zone and channel alias of the Geofence area is displayed. If the radio is set to manual, the user can choose either to proceed with zone and channel change or cancel the change.

The radio then connects to the designated talkgroup. The radio displays the talkgroup alias and dynamic regroup tone sounds. The transmit power level changes and the radio shows a direct text message content without any user operation.

**NOTICE:**

Depending on how your radio is programmed, you may or may not be alerted by Voice Announcement (VA), TMS display, Intelligent Backlight, and the Transmit Power Level. The user will be alerted only if these indicators are configured in the radio. The VA can be programmed to alert continuously or momentarily.

If Site Selectable Alert (SSA) is enabled, the radio mutes any alert that is received when entering the Geofence area and unmutes when exiting.

Exiting Mission Critical Geofence

When the radio exits the Geofence area, the radio reverts to the original transmit power level, intelligent lighting, channel or newly assigned talkgroup. Voice announcement is cancelled or the user hears a pre-programmed VA tone. The radio displays the new channel and a message is received to indicate the changes.

Trunking System Controls

This chapter explains the trunking system control features in your radio.

Operating in Failsoft System

The failsoft system ensures continuous radio communication during a trunked system failure. If a trunking system fails completely, the radio goes into failsoft operation and automatically switches to its failsoft channel.

During failsoft operation, your radio transmits and receives in conventional operation on a predetermined frequency. You hear a medium-pitched tone and the display shows `Failsoft`.

When the trunking system returns to normal operation, your radio automatically leaves failsoft operation and returns to trunked operation.

To continue in Failsoft and to communicate with other talkgroups, refer to the following procedure.

- 1 Rotate the **Mode Knob** to change to a different repeater frequency.

- 2 Press the **PTT** button to talk, and release the button to listen.

Out-of-Range Radio

When your radio goes out of the range of the system, it can no longer lock onto a control channel.

You hear a low-pitched tone and/or the display shows the currently selected zone/channel combination and *Out of range*. Your radio remains in this out-of-range condition until it locks onto a control channel, it locks onto a failsoft channel, or it is turned off.

Site Trunking Feature

If the zone controller loses communication with any site, that site reverts to site trunking.

The display shows the currently selected zone/channel combination and *Site trunking*.



NOTICE:

When this occurs, you can communicate only with other radios within your trunking site.

Locking and Unlocking a Site

This feature allows your radio to lock onto a specific site and not roam among wide-area talkgroup sites. This

feature should be used with caution, since it inhibits roaming to another site in a wide-area system.

You can toggle the lock state between locked and unlocked by pressing the preprogrammed **Site Lock/Unlock** button.

Follow the procedure to lock and unlock a site using the radio menu.

1  or  to *Site*.

2 Press the **Menu Select** button directly below *Site*.

3 Perform one of the following actions:

- To lock the site, press the **Menu Select** button directly below *Lock*. The display shows *Site locked*.
 - To unlock the site, press the **Menu Select** button directly below *Unlk*. The display shows *Site unlocked*.
-

The radio saves the new site lock state and returns to the Home screen.

Site Display and Search Button

The **Site Display** and **Site Search** button allows you to view the name of the current site or force your radio to change to a new one.

Viewing the Current Site

Perform one of the following actions:

- Press the preprogrammed **Site Displ/Srch** button.
- ◀ or ▶ to **RSSI** and press the **Menu Select** button directly below **RSSI**.

The display shows momentarily the name of the current site and its corresponding received **RSSI**.

Changing the Current Site

Perform one of the following actions:

- Press and hold down the preprogrammed **Site Displ/Srch** button.

- Press and hold down the **Menu Select** button directly below **RSSI**.

You hear a tone and the display shows momentary **Scanning site**.

When the radio finds a new site, it returns to the Home screen.

Mission Critical Wireless - Bluetooth®

This feature allows your radio to extend its functionality by connecting to external proprietary Motorola Solutions accessories.

It is recommended to use Motorola Solutions proprietary Mission Critical Wireless (MCW) devices with APX radios during Mission Critical operations as other Bluetooth devices may or may not meet the mission critical standard.

Your radio must be preprogrammed to allow you to use this feature.

The use of this feature requires the "Full Feature" expansion board together with the Bluetooth Software.



The default setting for Bluetooth-enabled radio is Bluetooth on. See [Turning Off the Bluetooth on page 162](#) to turn off the Bluetooth.



Currently your radio supports the following Bluetooth devices or profiles.

- Headset (HSP)
- Dial Up Networking (DUN)
- Personal Area Networking (PAN)
- Serial Port (SPP)
- Generic Access Profile (GAP)
- General Attribute Profile (GATT)

Turning On Bluetooth

Do one of the following to turn on the Bluetooth. You can use the options interchangeably depending on your preference and the programmed functions.

- Turning on the Bluetooth using the radio menu BT:
 - a.  or  to BT. To access the Bluetooth feature screen, press the **Menu Select** button directly below BT.

- b.  or  to Status and press the **Menu Select** button directly below On.

The display shows Status On, and  appears. If Bluetooth fails to launch, the display shows Bluetooth on failed.





- c. To return to the Home screen, press the **Menu Select** button directly below Exit.
- Turning on the Bluetooth using the preprogrammed button:
 - a. Press the preprogrammed button to turn on the Bluetooth.

You hear a short, medium-pitched tone. The display shows momentary Bluetooth on, and  appears. If Bluetooth fails to launch, the display shows Bluetooth on failed.

Turning Off the Bluetooth

Do one of the following to turn off the Bluetooth. You can use the options interchangeably depending on your preference and the programmed functions.

- Turning off the Bluetooth using the radio menu BT:

- a.  or  to BT. To access the Bluetooth feature screen, press the **Menu Select** button directly below BT.
- b.  or  to Status and press the **Menu Select** button directly below Off.

The display shows Status Off, and  disappears.

- c. To return to the Home screen, press the **Menu Select** button directly below Exit.
- Turning off the Bluetooth using the preprogrammed button:

- a. Press the preprogrammed button to turn off the Bluetooth.

You hear a short, medium-pitched tone. The display shows momentary Bluetooth off and  disappears.

Re-Pair Timer

There are two options for configuring the Bluetooth pairing type of the radio. The type defines the duration the radio and the accessory retain the pairing information.

Immediate

For MCW accessories only: When the radio and/or device is turned off after pairing, the keys are lost. Due to this, when your radio and your device are turned on again, they are unable to re-connect. The user must re-pair the devices to re-establish a new set of pairing keys. See [Pairing with Low Frequency-Motorola Proximity Pairing \(LF-MPP\) Feature on page 164](#) and [Standard Pairing Feature on page 166](#).

Infinite

For all Bluetooth devices: When the radio and/or device are turned off after pairing, keys are **not** lost. When the radio and the device are turned on again, they can

resume the Bluetooth connection without user intervention.

Re-Pair Timer Options

Re-Pair Timer Scenarios

Immediate (For MCW Accessories only)

- When the radio is powered off, pairing key is lost immediately, and accessory attempts to pair again. If pairing is unsuccessful within the Drop Timer value, the accessory automatically powers off.
- When the accessory is powered off, all keys are lost immediately, and the user must re-pair the devices.
- When the device loses Bluetooth connection, the device will attempt to re-establish Bluetooth Connection within the Drop Timer value.

Infinite (For all Bluetooth devices)

- When the radio is powered off, the accessory attempts to re-establish the Bluetooth Connection for a pe-

Re-Pair Timer Options

Re-Pair Timer Scenarios

riod of time depending upon the Drop Timer value. If the device fails to reconnect within the period, the accessory then powers off.

Bluetooth Drop Timer

The Bluetooth Drop Timer has two different settings and functions, depending upon the selection of the Re-Pair Timer.

Re-Pair Timer Options

Description

Immediate (For MCW Accessories only)

0–15 minutes programmable buffer time to re-establish the Bluetooth Connection when the Bluetooth signal is out of range. If either device powers **off**, the pairing keys are immediately cleared from both devices and the devices must re-pair.

Re-Pair Timer Options	Description
Infinite (For all Bluetooth devices)	<p>This Timer only applies to the accessory. The programmable timer choices are: 0–15 minutes, 2 hours, 4 hours, or 8 hours.</p> <p>Do note there are exceptions for Operation Critical Wireless (OCW) headset and PTT which are preprogrammed to 8 hours.</p> <p>This timer is a "stay alive" timer where the accessory remains on without the device reconnecting before powering off. The radio remains on until the user powers off the radio. The radio and accessory remains paired indefinitely. Once the device re-connect, the timer is reset.</p>

The radio could not control the Drop Timer of Personal Area Networking (PAN), Dial-Up Networking (DUN), Commercial Off- The-Shelf (COTS), and data services. It depends on the specifications of these external devices.

Check with your dealer or system administrator for more information about these timers.

To establish the Bluetooth Connection, see [Pairing with Low Frequency-Motorola Proximity Pairing \(LF-MPP\) Feature on page 164](#) or [Standard Pairing Feature on page 166](#).

Pairing with Low Frequency-Motorola Proximity Pairing (LF-MPP) Feature

Ensure that Bluetooth feature of your radio is on and the Bluetooth tones are enabled.

Bluetooth tones, Bluetooth menu and preprogrammed buttons must be preprogrammed by a qualified radio technician. Check with your dealer or system administrator for more information.

The range of Bluetooth operation when using a MCW accessory is 10 meters line-of-sight communication. This is an unobstructed path between the location of the signal transmitter (your radio) and the location of the receiver (your device or accessory).

Obstacles that can cause an obstruction in the line-of-sight include trees, buildings, mountains, cars, and others.

For high degree of reliability, Motorola Solutions recommends to **NOT** separate the radio and the accessory.

At the fringe areas of reception, both voice and tone quality will start to sound "garbled" or "broken". To correct this problem, simply position the accessory and radio closer to each other (within the 10 meter defined range) to re-establish clear audio reception.



NOTICE:

Once a COTS headset is paired to your radio, it is always connected. Therefore the battery life of the accessory is aligned with the Talk Time power consumption, not the Standby Time consumption.

Turn on the accessory. Then, place it close to the radio aligning the Bluetooth Pairing Location (a blue dot) on the radio to the Bluetooth Pairing Location (a blue dot) on the accessory.

If the pairing process is successful, you hear an incremental-pitched tone. The radio begins to connect to the device.

If the pairing process fails, you hear a short, low-pitched tone. The display shows `Bluetooth pairing failed`. Repeat this step.

The radio tries to establish connection with the device once paired.



NOTICE:

If the connection fails within 6 seconds, you hear a decremental-pitched tone to indicate that the device is unpaired. The display shows `<Device Type> unpaired`. Repeat this step to re-initiate the pairing process.

If the connection is successful, you hear an incremental-pitched tone. The display shows `<Device Type>`



`connected` and the Bluetooth icon turns from  to .

If the radio has the pairing record of the device and the connection fails, you hear a short, low-pitched tone. The display shows `<Device Type> connect failed`.

Radio Indications of Lost Bluetooth Connection

The radio shows  when the device has a Bluetooth connection. Below are the radio indications when the connection is interrupted.

The  starts blinking for up to 10 seconds. You hear a decremental-pitched tone. The display shows `<Device Type> alternating with disconnected`.

If the Bluetooth device successfully re-connects before the Bluetooth 10 second Re-Connection Timer expires, the display shows momentary <Device Type> connected, and  stops blinking, or if the Bluetooth device fails to re-connect within 10 seconds, the blinking  is replaced by a persistent .

Standard Pairing Feature



NOTICE:

Bluetooth tones, Bluetooth menu, and preprogrammed buttons must be preprogrammed by a qualified radio technician. Check with your dealer or system administrator for more information. Once a COTS headset is paired to your radio, it is always connected. Therefore the battery life of the accessory is aligned with the Talk time power consumption and not the Standby time consumption.

The Bluetooth Standard Pairing feature enables your Bluetooth enabled radio to search for other Bluetooth enabled and discoverable devices. Once a device is discovered, you can initiate your radio to send a pairing request to pair with the device.

This feature also enables your Bluetooth enabled radio to be visible to other Bluetooth enabled devices and receive request to pair from other devices.





The Standard Pairing feature supports pairing Authentication Personal Pairing Number or PIN which ensure your radio recognizes the correct device to pair. The PIN must be exchanged with the radio or the device before the pairing completes. Your radio prompts for the Authentication PIN when needed. Refer to your device's manual for details about the Bluetooth Authentication PIN of your device if needed.

Searching and Pairing the Bluetooth Device

Ensure the Bluetooth on your device is turned **on** and is set to **Discoverable** in order to enable your radio to detect your device in Bluetooth.



Bluetooth Search in Bluetooth Standard Pairing method is used to scan for other Bluetooth devices nearby. It is set to turn off by default.

- 1 Perform one of the following actions:
 - Press the preprogrammed **Bluetooth Search** button.

-  or  to BT. Press the **Menu Select** button directly below BT to access the Bluetooth feature screen.  or  to Search Devices and press the **Menu Select** button directly below On.

If successful, the display shows Searching for BT devices followed by the names of Bluetooth devices found, if any. When the search timer expires, **Available Dev** screen shows a list of Bluetooth devices found. To stop the search before the search timer expires, press the preprogrammed **Bluetooth Search** button or the **Menu Select** button below Stop.

If the feature fails to initiate, the radio sounds a short, low-pitched tone. The screen shows BT Search failed. Press the **Menu Select** button below Back to return to Bluetooth feature screen, or press  or the **Menu Select** button below Exit to return to **Home** screen.

-
- 2  or  to the device name and press the **Menu Select** button directly below Sel to connect to the device.





The radio starts pairing to the device.

To continue with Bluetooth pairing, see [Pairing with Low Frequency-Motorola Proximity Pairing \(LF-MPP\) Feature on page 164](#).

Turning On Bluetooth Visibility

Turning Bluetooth visibility on enables other Bluetooth devices to search for your radio. The visibility of the Bluetooth is set to turn off by default.

Do one of the following to turn on Bluetooth visibility. You can use the options interchangeably depending on your preference and the programmed functions.

- Turn on Bluetooth visibility using the radio menu BT:
 - a.  or  to BT. Press the **Menu Select** button directly below BT to access the Bluetooth feature screen.
 - b.  or  to Visibility and press the **Menu Select** button directly below On.

The status changes to Visible to all. Visibility mode is enabled.

When the timer expires, the status changes to Visibility failed. Repeat the procedure to turn on Bluetooth visibility.

- Turn on Bluetooth visibility using the preprogrammed button.
 - a. Press the preprogrammed button to enable the Bluetooth visibility feature.

You hear a short, medium-pitched tone. The display shows momentary `Visible to all`. Visibility mode is enabled.

When the timer expires, the display shows momentary `Visibility failed`. Repeat the procedure to turn on Bluetooth visibility.



NOTICE:

Press the preprogrammed button to toggle the Bluetooth visibility on or off.

Receiving Pairing Request from other Devices

When your radio receives a pairing request from other device, the display shows `<Device Friendly Name>pair request`.

Press the **Menu Select** button below `Ok` to accept or `Cncl` to refuse pairing request.

Turning Off Bluetooth Visibility

Ensure that Bluetooth Visibility is turned on.

The following methods are options on how to turn off Bluetooth visibility. The result of all the methods is the same. You can use the options interchangeably depending on your preference and the programmed functions.

- Turn off Bluetooth visibility using the radio menu `BT`:
 - a. `◀` or `▶` to `BT`. Press the **Menu Select** button directly below `BT` to access the Bluetooth feature screen.

- b. ▲ or ▼ to `Visibility` and press the **Menu Select** button directly below `Off`.

The display shows `Visibility Off`.

When the timer expires, the status changes to `Visibility off failed`. Repeat this step to turn off Bluetooth visibility.

- c. To return to the **Home** screen, press the **Menu Select** button directly below `Exit`.

- To disable the Bluetooth visibility, press the preprogrammed button.

You hear a short, medium-pitched tone. The display shows momentary `Visibility Off`. Visibility mode is disabled.

When the timer expires, the status changes to `Visibility off failed`. Repeat this step to turn off Bluetooth visibility.

PIN Authentication in Pairing

For the security of your radio, Bluetooth Pairing PIN feature is designed to enable your radio to verify the correct device

to pair before initiating the pairing. Authentic PIN is used for the verification.



NOTICE:

The pairing PIN authentication method is only applicable for Bluetooth version 2.1 and above.

Pairing the Authentication PIN when Receiving a Pairing Request

- 1 When the radio display shows `<Device Friendly Name> pair request`, perform one of the following actions:

- To accept, press the **Menu Select** button below `Ok`.
- To reject, press the **Menu Select** button below `Cncl`.

Your radio only supports HSP, DUN, GAP, PAN, and SPP Bluetooth profiles.

When the pairing timer expires, the display shows `<Device Friendly Name> pair canceled` and return to Home screen.

If you choose to accept the pairing process, the display shows `Compare PIN: XXXXXX`.

If you choose to reject the pairing process, the display shows `Cancel pairing in progress...` followed by `<Device Friendly Name> pair canceled` and return to Home screen.

- 2 Perform one of the following actions when the display shows `Compare PIN: XXXXXX:`
 - Press the **Menu Select** button below `Ok` if the PIN is correct.
 - Press the **Menu Select** button below `Cncl` to reject if the PIN number is incorrect. The display shows `Cancel pairing in progress...` followed by `<Device Friendly Name> pair canceled` and return to Home screen.

When the PIN authentication timer expires, the display shows `<Device Friendly Name>pair canceled` and return to Home screen.

If successful, the display shows `Pairing in progress...., <Device Friendly Name> paired` followed by `<Device Friendly Name>connected`.



If unsuccessful, one of the following scenarios will occur:

- The display shows `<Device Friendly Name> pair failed` (if the pairing timer expires).
- The display shows `<Device Friendly Name> connect failed` (if the connecting timer expires).

If the PIN is correct but the profiles are not supported, the display shows `BT profiles not supported`. The display returns to Home screen.

Pairing the Authentication PIN with the Generated Numeric PIN

Follow the procedure in [Searching and Pairing the Bluetooth Device on page 166](#) to search for available Bluetooth devices. Start pairing with the Authentication PIN by following the steps described next.

- 1  or  to the required device. Press the **Menu Select** button directly below `Se1` to initiate pairing.

Your radio only supports HSP, DUN, GAP, PAN, and SPP Bluetooth profiles.

If successful, the display shows `Pairing in progress...` followed by a randomly generated numeric PIN, `Compare PIN: XXXXXX`.

If unsuccessful, the display shows `BT profiles not supported`. The display returns to **Available Dev** screen.

-
- 2 Press **Ok** to continue pairing the radio and the device.

The pairing process can be canceled by pressing the **Menu Select** button below **Cncl**.

If successful, the display shows `Pairing in progress,<Device Friendly Name> paired, Connecting in progress...` followed by `<Device Friendly Name>connected`. The display returns to the Bluetooth feature screen.

If unsuccessful, one of the following scenarios will occur:

- The display shows `<Device Friendly Name> pair failed` (if the PIN numbers are different).

- `<Device Friendly Name> connect failed` (if the connection fails).

The display returns to **Available Dev** screen.

Turning On the Bluetooth Audio

Do one of the following to turn on the Bluetooth audio. You can use the options interchangeably depending on your preference and the programmed functions.

- Turning on the Bluetooth audio using the radio menu **BT**:
 - a. **◀** or **▶** to **BT**. Press the **Menu Select** button directly below **BT** to access the Bluetooth feature screen.
 - b. **▲** or **▼** to **Bluetooth spkr** and press the **Menu Select** button directly below **On**.
The display shows **On**.
 - c. To return to the Home screen, press the **Menu Select** button directly below **Exit**.
- Turning on the Bluetooth audio using the preprogrammed button:

- a. To route the audio routing from the radio to the headset, short press the preprogrammed button.

You hear a short, medium-pitched tone. The display shows `Headset on`.

BT audio routing can be configured in CPS to route the audio to RSM or radio's internal speaker. The audio routes to the radio's speaker if RSM is not connected. Check with your dealer or system administrator for more information on the programming of this feature.



NOTICE:

For BT PTT press, the active microphone can be configured in CPS to transmit from either the RSM, the radio microphone, or the BT headset. If the configured device is not available, audio transmission reverts to BT headset.

Turning Off the Bluetooth Audio

Do one of the following to turn off the Bluetooth Audio. You can use the options interchangeably depending on your preference and the programmed functions.

- Turning off the Bluetooth audio using the radio menu BT:
 - a. ◀ or ▶ to BT. Press the **Menu Select** button directly below BT to access the Bluetooth feature screen.
 - b. ▲ or ▼ to `Bluetooth spkr` and press the **Menu Select** button directly below `Off`.
The display shows `Off`.
 - c. To return to the Home screen, press the **Menu Select** button directly below `Exit`.
- Turning off the Bluetooth audio using the preprogrammed button:
 - a. To route the audio routing from the headset to the radio, press the preprogrammed button.
You hear a short, medium-pitched tone. The display shows `Speaker on`.

Adjusting the Volume of the Radio from Bluetooth Audio Device

Ensure that the Bluetooth audio device is connected to the radio.

Your radio can only control the volume of MCW and OCW Bluetooth enabled audio device. If the radio is paired with other Bluetooth enabled audio device, its volume is independent from the APX radio. In this case, the volume is only adjustable on the device.

Adjust volume up/down on the Bluetooth audio device.

The radio display shows Volume XX, and you hear a short, medium-pitched tone.

Viewing and Clearing the Bluetooth Device Information

- 1 ◀ or ▶ to BT. Press the **Menu Select** button directly below BT to access the Bluetooth feature screen.

- 2 ▲ or ▼ to Devices.

Once the display highlights the Devices, the display shows XX connected alternates with XX paired.

- 3 Press the **Menu Select** button directly below Sel.

- 4 If there are devices being paired or connected, ▲ or ▼ along the list of <Device Friendly Name> to see the status of each device.

If there are no active Bluetooth devices being paired or connected, the display shows No devices.

- 5 Perform one of the following actions:

- To clear the device from the list, ▲ or ▼ to the required device, press the **Menu Select** button directly below Clr.
- To exit from this function, press the **Menu Select** button directly below Back to return to the previous screen without deleting the device name.

If Clr is selected, the display shows <Device Friendly Name> clear?.

- 6 Press the **Menu Select** button directly below `Yes` or `No` to proceed delete the device or to exit this function and return to previous screen.

If the device is deleted successfully, the display shows `<Device Friendly Name> cleared` to indicate clearing is successful.

If the device is not deleted successfully, you hear the radio sounds a short, low-pitched tone. The display shows `<Device Friendly Name> clear failed`. The display returns to previous screen.



NOTICE:

If Re-Pair Timer is set to infinite and you clear keys on the radio, you must clear keys on all previously paired devices as well. (Please see your *Accessories manual* for further details.)

Clearing All Bluetooth Devices Information

Do one of the following to clear all Bluetooth devices information. You can use the options interchangeably

depending on your preference and the programmed functions.

- Clearing all Bluetooth devices information using the preprogrammed **Bluetooth On/Off** button:

- a. Long press the preprogrammed **Bluetooth On/Off** button.

You hear a short, medium-pitched tone. The display shows `Please wait` to indicate clearing is in progress.

If successful, the display shows `All BT devices cleared`.

If unsuccessful, the radio sounds a short, low-pitched tone. The display shows `Clear all BT devices failed`. The display returns to Bluetooth feature screen.

- Clearing all Bluetooth devices information using the radio menu `Clr`:

- a. `▲` or `▼` to `Devices` and press the **Menu Select** button directly below `Clr`.

You hear a short, medium-pitched tone. The display shows `Clear all BT devices?`.

- b. Press the **Menu Select** button directly below `Yes` to proceed.

The display shows `Please wait` to indicate clearing is in progress.

If successful, the display shows `All BT devices cleared`.

If unsuccessful, you hear the radio sounds a short, low-pitched tone. The display shows `Clear all BT devices failed`. The display returns to Bluetooth feature screen.



NOTICE:

If Re-Pair Timer is set to infinite and you clear keys on the radio, you must clear keys on all previously paired devices as well. (Please see your accessories manual for further details.)

Editing the Bluetooth Friendly Name

Your radio must be preprogrammed to allow you to use this feature.

- 1 `◀` or `▶` to `BT`. Press the **Menu Select** button directly below `BT` to access the Bluetooth feature screen.
-

- 2 `▲` or `▼` to `Friendly name` and press the **Menu Select** button directly below `Edit`.

A blinking cursor appears in the `Friendly Name` screen.

- 3 Use the **keypad** to edit the text.
-

- 4 Perform one of the following actions:

- Press the **Menu Select** button directly below `Ok` to save the new `Friendly Name` and return to the Bluetooth feature screen.
 - Press the **Menu Select** button directly below `Cncl` to return to the Bluetooth feature screen.
-

Pairing with LEX Handheld

Ensure that Bluetooth feature of your radio is on and the Bluetooth tones are enabled.

- 1 Turn on the handheld and activate the Bluetooth feature.
-

- 2 Place the handheld close to the radio aligning the Bluetooth Pairing Location on the handheld with the Bluetooth Pairing Location on the radio.

If the pairing process is successful, you hear an incremental-pitched tone from the radio. The radio begins to connect to the handheld. If the connecting process is successful, you hear an incremental-pitched tone. The display shows <Device Friendly Name> connected, and the Bluetooth icon turns

from  to .

If unsuccessful, one of the following scenarios occur:

- You hear a short, low-pitched tone and the display shows Bluetooth pairing failed (if pairing fails).
- You hear a decremental-pitched tone and the display shows <Device Friendly Name> unpaired (if the connection fails within 6 seconds).
- You hear a short, low-pitched tone and the display shows <Device Friendly Name> connect failed (if the radio has the pairing record of the handheld and the connection fails).

Repeat this step to re-initiate the pairing process.



NOTICE:

To unpair the handheld after a successful connection, follow the steps in [Viewing and Clearing the Bluetooth Device Information on page 173](#).

Holster Sensor

Holster sensor allows the radio to send notification over-the-air (OTA) when a holster event or multiple holster events occurs.

To enable the feature, ensure that the GPS, Enhanced Data, and Bluetooth feature of your radio is on and the radio supports Bluetooth Low Energy (BT-LE).

You can disable the sensor temporarily or permanently. This feature allows you to suppress one or all holster events from being reported OTA.

The radio triggers a visual and audible notification when the holster sensor battery is below the preset threshold value. The radio displays <BT alias> low batt and a tone sounds.

This feature is enabled through CPS configuration. Check with your dealer or system administrator for more information on the programming of this feature.

Disabling Holster Sensor Temporarily

- 1 Short-press the preprogrammed **Sensor** button to disable OTA Sensor notification.

A tone sounds and the radio displays `Sensor Disable`.

- 2 Press the **Menu Select** button directly below `Sensor Disable` to disable the OTA notification.

The radio remains in this state for a time specified in radio's codeplug programming. If the timer expires without an unholster event, a tone sounds, the radio re- enables the sensor feature and clear sensor status from the display.

- 3 When the gun is placed back in the holster, a tone sounds, the radio enables the OTA sensor notification and the radio displays `Sensor On` temporarily.
-

- 4 Long press the preprogrammed **Sensor** button to cancel this operation and enable the sensor notification.
-

Disabling Holster Sensor Permanently

- 1 Long-press the preprogrammed **Sensor** button to disable OTA Sensor notification.

A tone sounds and the radio displays `Sensor Off`. While in this state, no holster events will be reported OTA, regardless of how many times the gun is drawn or re-inserted.

- 2 Long-press the preprogrammed **Sensor** button again to enable the OTA Sensor notification.

A tone sounds, and the radio displays `Sensor On`. The radio generates a bad key tone if the sensor is not allowed to be disabled.

Over-the-Air Programming (POP 25, ASTRO 25, and ASTRO Conventional and Wi-Fi)

This feature enables configuration data and firmware to be upgraded to your radio over-the-air. Full use of the radio is retained during the data transfer without interrupting communication. For ASTRO 25 and ASTRO Conventional,

the upgrade pauses to give priorities to voice call, and continues after the voice call ended. For Wi-Fi, the upgrade process runs concurrently with voice calls.

Once a configuration upgrade is downloaded to your radio, you can install new changes immediately or delay changes to be installed on the radio when it is being powered up.

Your radio can also be configured to allow you to accept or reject an upgrade.



NOTICE:

This feature must be preprogrammed by a qualified radio technician. Check with your dealer or system administrator for more information.

Responding to the Notification of Upgrade

- 1 The display shows `Upgrade?` and two short, medium-pitched tones sound every 30 seconds until the user makes a choice of either accepting, delaying, or rejecting the request.
- 2 Perform one of the following actions:
 - Press the **Menu Select** button below `Acpt` to accept the request to upgrade immediately.

- Press the **Menu Select** button below `Delay` to delay the request to upgrade.
- Press the **Menu Select** button below `Rej` to reject the request to upgrade.

One of the following scenarios occurs:

- If you choose to accept, the display shows `Programming Dont power off` to indicate the upgrade is about to begin. The radio resets to install the upgrade. In the case of configuration data upgrade, the process only takes a few seconds. In the case of firmware upgrade, the installation takes several minutes.



NOTICE:

The radio cannot be used while the upgrade is being installed. Therefore, make sure to only accept the upgrade at a convenient time when immediate radio use is not required.

- If you choose to delay, a configuration data upgrade is installed automatically at the next power up. However, in the case of a firmware upgrade, the radio prompts `Upgrade?` again at the next power up.
- If you choose to reject, the display shows `Upgr Aborted`. The radio continues to function with the current configuration until it gets reprogrammed.

**NOTICE:**

If your radio has problems upgrading over-the-air, consult a qualified technician for details.

Voice Announcement

This feature enables the radio to audibly indicate the current feature mode, zone or channel the user has just assigned. This audio indicator can be customized per customer requirements. This is typically useful when the user is having difficulty reading the content shown on the display.

Each voice announcement is within a limit of three seconds maximum. The sum duration of all different voice announcements in a radio shall be no more than 1000 seconds.

**NOTICE:**

This feature must be preprogrammed by a qualified radio technician.

Check with your agent if Voice Announcement is available for the feature you need.

The two options of priority for the Voice Announcement available are:

High

Enables the voice of the feature to announce even when the radio is receiving calls.

Low

Disables the voice of the feature from announcing when the radio is receiving calls.

You hear a voice announcement when the features below are preprogrammed in the radio.

- The radio powers up. The radio announces the current zone and channel it is transmitting.
- Press the preprogrammed voice announcement button (which specifically programmed to playback the current zone and channel). The radio announces the current zone and channel it is transmitting.

**NOTICE:**

Pressing this preprogrammed playback button enables the voice feature to announce in High priority.

All the three programmable buttons at the side of the radio support this feature.

- Change to a new zone. The radio announces the current zone and channel it is transmitting.
- Change to a new channel remaining within the current zone. The radio announces the current channel.

- Press either the **Menu Select** button or preprogrammed button or switch of the radio to launch or terminate Scan, PL Disabled, Talkaround/Direct, or Transmit Inhibit. The radio announces the corresponding feature activation or deactivation.

Site Selectable Alerts (ASTRO 25)

A Site Selectable Alert (SSA) is an Intelligent Lighting indicator together with audio alert sent to radios at a site or a few sites to notify the users when there is a special situation that they need to be aware of.

Your radio supports up to 250 site aliases. Only authorized radios are enabled to send SSA. Upon the activation of a SSA, the receiving radios display the alert alias and generate the periodic alert tone.





NOTICE:

Alert alias, alert tone, and alert period can be preprogrammed. Alert period is the duration for the radio to repeat the alert tone. An interval of 5 seconds might impact the battery life of the radio. Check with your dealer or system administrator for more details.

When mixing SSA with received voice audio, the SSA alert is reduced in volume to ensure that the voice message is still heard clearly. Therefore, it is important that the SSA audio files are created with clear loud audio to ensure they can still be heard clearly when played at reduced levels.

Sending SSA Notification to Single Site

- 1  or  to SSA.
-
- 2 Press the **Menu Select** button directly below SSA.
The display shows the **Site Alert** screen.
-

- 3 ▲ or ▼ to Start Alert and press the **Menu Select** button directly below Sel.

The display shows the **Select Site** screen.

- 4 ▲ or ▼ to the desired Site Alias. Press the **Menu Select** button directly below Sel.

The display shows the **Select Alert** screen.

- 5 ▲ or ▼ to select the desired Alert Alias and press the **Menu Select** button directly below Send.

The display shows Sending req.

If radio is out of range, roaming to a foreign system or in a failsoft situation, the display shows Req failed.

If the request is successful, the display shows Req successful.

If the site is not available, the display shows <Site Alias> not available.

If the site does not exist, the display shows <Site Alias> does not exist.

- 6 To return to the Home screen, press the **Menu Select** button directly below Exit.
-

If you are at the site designated to receive this alert, you can hear an alert tone repeated periodically. The display shows the <Alert Alias> with the intelligent lighting at Home screen.

Sending SSA Notification to Single Site by Manual Entry

- 1 ◀ or ▶ to SSA.
-

- 2 Press the **Menu Select** button directly below SSA.
The display shows the **Site Alert** screen.
-

- 3 ▲ or ▼ to Start Alert and press the **Menu Select** button directly below Sel.

The display shows the **Select Site** screen.

- 4 ▲ or ▼ to [SiteID Entry] to send alert through the manual entry. Press the **Menu Select** button directly below Edit.

The display shows the **Enter SiteID** screen.

- 5 Key in the desired Site ID and press the **Menu Select** button directly below Ok.

If a correct Site ID is entered, the display shows the **Select Alert** screen.

If a wrong Site ID is entered, the display shows Invalid ID and prompts to enter the Site ID again.

- 6 ▲ or ▼ to select the desired Alert Alias and press the **Menu Select** button directly below Send.

The display shows Sending req.

If radio is out of range, roaming to a foreign system or in a failsoft situation, the display shows Req failed.

If the request is successful, the display shows Req successful.

If the site is not available, the display shows <Site ID> not available.

If the site does not exist, the display shows <Site ID>does not exist.

- 7 To return to the Home screen, press the **Menu Select** button directly below Exit.
-

If you are at the site designated to receive this alert, you can hear an alert tone repeated periodically. The display shows the <Alert Alias> with the intelligent lighting at Home screen.

Sending SSA Notification to All Sites

- 1 ◀ or ▶ to SSA.
-

- 2 Press the **Menu Select** button directly below SSA.
The display shows the **Site Alert** screen.
-

- 3 ▲ or ▼ to Start Alert and press the **Menu Select** button directly below Sel.

The display shows the **Select Site** screen.

- 4 ▲ or ▼ to [All Sites] and press the **Menu Select** button directly below Sel.

The display shows the **Select Alert** screen.

- 5 ▲ or ▼ to select the desired <Alert Alias> and press the **Menu Select** button directly below Send.

The display shows Sending req.

If radio is out of range, roaming to a foreign system or in a failsoft situation, the display shows Req failed.

If the request is successful, the display shows Req successful.

If one or more sites are not available, the display shows Not all sites available. Repeat [step 3](#).

- 6 To return to the Home screen, press the **Menu Select** button directly below Exit.
-

If you are at the site designated to receive this alert, you can hear an alert tone repeated periodically. The display shows the <Alert Alias> with the intelligent lighting at Home screen.

Sending SSA Notification to All Available Sites

- 1 ◀ or ▶ to SSA.
-

- 2 Press the **Menu Select** button directly below SSA.

The display shows the **Site Alert** screen.

- 3 ▲ or ▼ to Start Alert and press the **Menu Select** button directly below Sel.

The display shows the **Select Site** screen.

- 4 ▲ or ▼ to [All Avail] and press the **Menu Select** button directly below Sel.

The display shows the **Select Alert** screen.

- 5 ▲ or ▼ to select the desired Alert Alias and press the **Menu Select** button directly below Send.

The display shows Sending req.

If radio is out of range, roaming to a foreign system or in a failsoft situation, the display shows Req failed.

If the request is successful, the display shows Req successful.

-
- 6 To return to the Home screen, press the **Menu Select** button directly below Exit.
-

If you are at the site designated to receive this alert, you can hear an alert tone repeated periodically. The display shows the <Alert Alias> with the intelligent lighting at Home screen.

Stopping SSA Notification of a Single Site

- 1 ◀ or ▶ to SSA.
-
- 2 Press the **Menu Select** button directly below SSA.
The display shows the **Site Alert** screen.
-
- 3 ▲ or ▼ to Stop Alert and press the **Menu Select** button directly below Sel.
The display shows the **Select Site** screen.
-

- 4 ▲ or ▼ to select the desired Site Alias and press the **Menu Select** button directly below Send.

The display shows Sending req.
If radio is out of range, roaming to a foreign system or in a failsoft situation, the display shows Req failed.

If the request is successful, the display shows Req successful.

If the site is not available, the display shows <Site Alias> not available.

If the site does not exist, the display shows <Site Alias>does not exist.

-
- 5 To return to the Home screen, press the **Menu Select** button directly below Exit.
-

The SSA Alert for the designated site stops.

Stopping SSA Notification of a Single Site by Manual Entry

- 1 ◀ or ▶ to SSA.
-

- 2 Press the **Menu Select** button directly below SSA.

The display shows the **Site Alert** screen.

- 3 ▲ or ▼ to Stop Alert and press the **Menu Select** button directly below Sel.

The display shows the **Select Site** screen.

- 4 ▲ or ▼ to [SiteID Entry] and press the **Menu Select** button directly below Edit.

The display shows the **Enter SiteID** screen.

- 5 Key in the required Site ID and press the **Menu Select** button directly below Send.

One of the following scenarios occur:

- If a wrong Site ID is entered, the display shows Invalid ID and prompts to enter the Site ID again.
- If a correct Site ID is entered, the display shows Sending req.
- If the request is successful, the display shows Req successful.

- If the single site is not available, the display shows <Site ID> not available.
 - If the single site does not exist, the display shows <Site ID> does not exist.
-

- 6 To return to the Home screen, press the **Menu Select** button directly below Exit.
-

The SSA Alert for the designated site stops.

Stopping SSA Notification of All Sites

- 1 ◀ or ▶ to SSA.
-

- 2 Press the **Menu Select** button directly below SSA.
The display shows the **Site Alert** screen.
-

- 3 ▲ or ▼ to Stop Alert and press the **Menu Select** button directly below Sel.
The display shows the **Select Site** screen.
-

- 4 ▲ or ▼ to [All Sites] and press the **Menu Select** button directly below Send.

The display shows Sending req.

If radio is out of range, roaming to a foreign system or in a failsoft situation, the display shows Req failed.

If the request is successful, the display shows Req successful.

If one or more sites are not available, the display shows Not all sites available. Repeat [step 3](#).

- 5 To return to the Home screen, press the **Menu Select** button directly below Exit.
-

The SSA Alert for all sites stop.

Stopping SSA Notification of All Available Sites

- 1 ◀ or ▶ to SSA.
-

- 2 Press the **Menu Select** button directly below SSA.
The display shows the **Site Alert** screen.
-

- 3 ▲ or ▼ to Stop Alert and press the **Menu Select** button directly below Sel.

The display shows the **Select Site** screen.

- 4 ▲ or ▼ to [All Avail] and press the **Menu Select** button directly below Send.

The display shows Sending req.

If radio is out of range, roaming to a foreign system or in a failsoft situation, the display shows Req failed.

If the request is successful, the display shows Req successful.

- 5 To return to the Home screen, press the **Menu Select** button directly below Exit.
-

The SSA Alert for all available sites stop.

Wi-Fi

This feature allows you to turn Wi-Fi on or off. Wi-Fi can be used for wireless programming of the radio with the Radio Management tool.



NOTICE:

This feature is available to capable and ordered option.

Wi-Fi Network Name (SSID) for the radio to connect to must be preprogrammed by a qualified radio technician. Check with your dealer or system administrator for more information.

Turning Wi-Fi On or Off

Do one of the following to turn Wi-Fi on or off. You can use the options interchangeably depending on your preference and the programmed functions.

- Turning Wi-Fi on or off using the preprogrammed button:
 - a. To toggle the Wi-Fi on or off, press the preprogrammed **Wi-Fi** button.

This button must be preprogrammed by a qualified radio technician. Check with your dealer or system administrator for more information.

- Turning Wi-Fi on or off using the radio menu button:
 - a. ◀ or ▶ to WiFi and press the **Menu Select** button directly below WiFi.
 - If the display shows WiFi Status being Off, press the **Menu Select** button directly below On.
 - If the display shows WiFi Status as Searching, Connecting, Connected or No Service, press the **Menu Select** button directly below Off to turn Wi-Fi off.

Selecting WiFi Network

This feature allows you to view and select the available WiFi network.

- 1 Press the **Menu Select** button directly below WiFi to enter WiFi screen.
-

- 2 Press the **Menu Select** button directly below `On` to turn on the WiFi.

Radio starts searching for available network.

- 3 Press the **Menu Select** button directly below `List`.

Radio displays available network selection and the network signal strength.

If the radio displays `No network available`, press the **Menu Select** button directly below `Rfsh` to search for available networks.

- 4 Press `▲` or `▼` to scroll through the list and press **Menu Select** button directly below `Sel` to connect to the selected network.
-

Radio displays the WiFi status, the selected network, and the signal strength.



NOTICE:

The **List** and `Rfsh` buttons are not available when WiFi is searching or connecting to network.

Checking the Wi-Fi Configuration and Status of the Radio

- 1 Perform one of the following actions:

- Long press the preprogrammed **Wi-Fi** button.
- `◀` or `▶` to `WiFi` and press the **Menu Select** button directly below `WiFi`.

The display shows the current status of the Wi-Fi as described next.

Searching

Looking for available Wi-Fi networks that have been preprogrammed into the radio.

Connecting

In the process of connecting to a found Wi-Fi network.

Connected

Connected to one of the preprogrammed Wi-Fi networks.

No Service

No available networks or connection with one of the networks failed.

If the radio is Wi-Fi connected, you see a Wi-Fi signal strength indicator,  on the front display. In addition, the WiFi menu shows `Connected` under the connection Status heading, what network you are connected to under the Network heading, and the signal strength to that network under the Sig Strength heading.

2 Press  to exit.

Utilities

This chapter explains the operations of the utility functions available in your radio.

Viewing Recent Calls

This feature allows you to view the recent incoming and outgoing call information of the following call types:

- Call Alert
- Selective Call
- Private Call
- Phone Call (Outgoing Only)





- Emergency Call (Incoming Only)



NOTICE:

The radio can also be preprogrammed to log only the radio IDs associated with incoming Dispatch Calls. Check with your dealer or system administrator for more information.

Do one of the following to view recent calls. You can use the options interchangeably depending on your preference and the programmed functions.

- Viewing recent calls using the preprogrammed **Recent Calls** button:
 - a. Press the preprogrammed **Recent Calls** button.
 - b.  or  to scroll through the list.
 - c. To return to the Home screen, press the **Menu Select** button directly below `Exit`, press  or the **PTT** button.
- Viewing recent calls using the radio menu:
 - a.  or  to `Rcnt`.
 - b. Press the **Menu Select** button directly below `Rcnt` to access the `Recent Calls` feature screen.

- c. ▲ or ▼ to scroll through the list.
- d. To return to the Home screen, press the **Menu Select** button directly below **Exit**,  or the **PTT** button.

The radio automatically exits the feature, if the feature inactivity timer is enabled, when the radio is left idle and the timer expires. You will hear the Menu Inactive Exit Tone upon feature exit.

Using the Flip Display

This feature allows you to flip the content of the top display upside down. It is particularly useful when you would like to read the top display while the radio is still in the carry holder attached to your belt.

To flip the display, press and hold the preprogrammed **Light/Flip** button.

Selecting a Basic Zone Bank

The Basic Zone Select feature must to be preprogrammed to the **3-position A-B-C** switch, while the Basic Zone Bank feature must be preprogrammed to any **side** button or **Top (Orange)** button before you can use this feature.

This feature allows twice as many zones to be accessed from a switch, doubling the amount of switch positions.

Use the preprogrammed **Basic Zone Bank** button to toggle the position between Bank 1 and Bank 2.

The top display shows the status icons (A, B, C, D, E, or F) or the zone name based on the bank and switch position selected.



NOTICE:

See the [Basic Zone Bank 1](#) and [Basic Zone Bank 2](#) icons for more information on the status icons.

Selecting the Power Level



NOTICE:

This feature must be preprogrammed by a qualified radio technician.

This feature enables you to reduce the transmit power level for specific case that requires a lower power level. You can select the power level at which your radio transmits. The radio always turns on to the default setting. These reduced transmit power level settings do not affect the receiving performance of your radio, nor diminish the overall quality

of the audio and data functionality of the radio given the following conditions.

Power level **Low** enables a shorter transmitting distance and to conserve power. Power level **High** enables a longer transmitting distance.

Do one of the following to select the power level. You can use the options interchangeably depending on your preference and the programmed functions.

- Selecting the Power Level using the **Transmit Power Level** switch:
 - a. Use the preprogrammed **Transmit Power Level** switch to toggle the power level between low and high power.
- Selecting the Power Level using the radio menu:
 - a. ◀ or ▶ to **Pwr.**
 - b. Press the **Menu Select** button directly below **Pwr.**

The display shows **Low power** and the low power icon or the display shows **High power** and the high power icon.

Selecting a Radio Profile

This feature allows you to manually switch the visual and audio settings of the radio. The display, backlight, alert

tones, and audio settings are defined according to the preprogrammed radio settings of each radio profile. Please refer to a qualified technician for more information.







NOTICE:

The radio automatically exits the feature, if the feature inactivity timer is enabled, when the radio is left idle and the timer expires. You will hear the Menu Inactive Exit Tone upon feature exit.

Do one of the following to select a radio profile. You can use the options interchangeably depending on your preference and the programmed functions.

- Selecting a radio profile using the preprogrammed **Profile** button:
 - a. Press the preprogrammed **Profile** button.
 - b. ▲ or ▼ to scroll through the menu selections.
 - c. Press the **Menu Select** button directly below **Sel** to select the required radio profile, or press the **Menu Select** button directly below **Exit** to exit the screen without making any changes.

The radio returns to the Home screen. The profile name on the Home screen indicates the current selected radio profile.

- Selecting a radio profile using the radio menu:
 - a.  or  to `Prfl` and press the **Menu Select** button directly below `Prfl` to access the `Profiles` feature screen.
 - b.  or  to scroll through the menu selections.
 - c. Press the **Menu Select** button directly below `Sel` to select the required radio profile, or press the **Menu Select** button directly below `Exit` to exit the screen without making any changes.

The radio returns to the Home screen. The profile name on the Home screen indicates the current selected radio profile.

Selecting an Enhanced Zone Bank

This feature is created in order to allow users to communicate in more zones. An **Enhanced Zone Bank (EZB)** consists of three zones. This also means each icon `A`, `B`, `C`, ... or `Y` consist of three zones. You can use the preprogrammed **3-position A-B-C** switch to select the first, second or third zone in an EZB.

This feature allows user to navigate from up to 75 zones in 25 EZBs.



NOTICE:

The Zone Select feature must to be preprogrammed to the **3-position A-B-C** switch, while the Enhanced Zone Bank feature must be preprogrammed to any **side** button or **Top (Orange)** button before you can use this feature.

- 1 Press the preprogrammed **EZB Up** or **EZB Down** button to scroll the EZB up or down or press and hold the preprogrammed **EZB Up** or **EZB Down** button to fast scroll the EZB up or down.
-
- 2 Turn the **3-Position A/B/C** Switch to select the first, second or third zone in the selected EZB.
-

Enabling and Disabling the Radio Alias

This feature allows you to display or hide the radio alias (name).

Press the **Menu Select** button directly below `MjID`.

The display shows momentary `Radio ID` off, and the radio alias disappears from the Home screen or the display shows momentary `Radio ID` on, and the radio alias appears on the Home screen.

Controlling the Display Backlight

You can enable or disable the radio display backlight as needed, if poor light conditions make the display or keypad difficult to read.

Depending on how your radio is preprogrammed, you can also maintain a minimum backlight level on the radio front display.



NOTICE:

The backlight setting also affects the **Menu Select** buttons, the **Navigation** button and the **keypad** backlighting accordingly.

The backlight remains on for a preprogrammed time before it automatically turns off completely or returns to the minimum backlight level.

The preprogrammed **Light/Flip** button of the accessories connected to the radio such as Display Remote Speaker Microphone (DRSM) is disabled when the radio is in Night Vision Goggles (NVG) display mode.

Perform one of the following actions:

- To toggle the backlight on or off, press the preprogrammed **Light/Flip** button.

- To turn the backlight on, press any key of the **keypad**, the **Menu Select** or **Navigation** button, or any programmable radio controls or buttons.
-

Setting Up the Radio Display and Visual Indicators to Suit Night Vision Goggles

During tactical nighttime operations of military entities worldwide, the Night Vision Goggles (NVG) is used to see in the dark. Your radio is 3rd generation NVG compatible. When the radio is in NVG display mode, the radio's front display and top display emit a very low illumination backlight to allow the user to operate the radio with the goggles on.



CAUTION:

Remove your NVG if you operate the radio in non-NVG compatible display mode. Wearing the NVG to operate in non-NVG compatible display mode might injure your eyes.

Accessory connected to the radio that is in NVG display mode such as Display Remote Speaker Microphone (DRSM) has its backlight always in off state.

Intelligent lighting indicators, TX LED and RX LED are all disabled on both the radio and the connected accessory when the radio is in NVG display mode.



NOTICE:

Get familiar with your radio NVG feature and operation before you use it with your Night Vision Goggles.

This feature is only available on APX 8000H models with the SRX Enhancement Package.

Do one of the following to set up the radio display and visual indicators. You can use the options interchangeably depending on your preference and the programmed functions.

- Setting up the radio display and visual indicators using the preprogrammed **Profile** button:
 - a. Press the preprogrammed **Profile** button.
 - b. ▲ or ▼ to the designated NVG profile.
 - c. To select the required radio profile, press the **Menu Select** button directly below `Sel` or to exit the screen without making any changes, press the **Menu Select** button directly below `Exit`.

The radio returns to the Home screen with NVG display mode. The profile name on the Home

screen indicates the current selected radio profile.

- Setting up the radio display and visual indicators using the radio menu `Prfl1`:
 - a. ◀ or ▶ to `Prfl1`.
 - b. To access the `Profiles` screen, press the **Menu Select** button directly below `Prfl1`.
 - c. ▲ or ▼ to the designated NVG profile.
 - d. To select the required radio profile, press the **Menu Select** button directly below `Sel` or to exit the screen without making any changes, press the **Menu Select** button directly below `Exit`.

The radio returns to the Home screen with NVG display mode. The profile name on the Home screen indicates the current selected radio profile.

Locking and Unlocking the Keypad and Controls

You can lock the keypad, programmable buttons, rotary knobs, and switches of your radio to avoid inadvertent

entry. Check with your dealer or qualified technician for best selection to suit your usage.

- 1 Toggle the preprogrammed **Keypad/Control Lock** button or switch to on.

The display shows Kypd/Ctrl Lock.

- 2 Toggle again to unlock the controls.
-

Turning the Controls and Keypad Buttons Tones On or Off

You can enable and disable the tones of Navigation buttons, controls and keypad if needed.

- Turning the tones on or off using the preprogrammed **Mute** button:
 - a. To turn the tones off or on, press the preprogrammed **Mute** button.
- Turning the tones on or off using the radio menu:
 - a. ◀ or ▶ to Mute.

- b. Press the **Menu Select** button directly below Mute.

The display shows momentary Tones off, indicating that the tones are disabled or the display shows momentary Tones on, and you hear a short tone indicating that the tones are enabled.

Turning Voice Mute On or Off

You can enable and disable voice transmission, if needed. Do one of the following to turn Voice Mute on or off. You can use the options interchangeably depending on your preference and the programmed functions.

- Turning Voice Mute off or on using the preprogrammed **Voice Mute** button:
 - a. To turn the feature off or on, press the preprogrammed **Voice Mute** button.
- Turning Voice Mute on or off using the radio menu:
 - a. ◀ or ▶ to VMut.

- b. Press the **Menu Select** button directly below `UMut`.

The display momentarily shows `Voice mute off`, and you hear a short tone, indicating that the feature is disabled or the display shows momentary `Voice mute on`, and you hear a short tone, indicating that the feature is enabled.

Using the Time-Out Timer

This feature turns off the transmitter of your radio. You cannot transmit longer than the preset timer setting. If you attempt to do so, the radio automatically stops your transmission, and you hear a talk-prohibit tone.

The timer is defaulted at 60 seconds, but it can be preprogrammed from 3 to 120 seconds, in 15-second intervals, or it can be disabled entirely for each radio mode, by a qualified radio technician.



NOTICE:

You hear a brief, low-pitched, warning tone four seconds before the transmission times out.

- 1 Hold down the **PTT** button longer than the preprogrammed time.

You hear a short, low-pitched warning tone, the transmission is cut-off, and the LED goes out until you release the **PTT** button.

- 2 Release the **PTT** button.

The timer resets.

- 3 To re-transmit, press the **PTT** button.

The time-out timer restarts and the LED lights up solid red.

Time and Date Setup

You can set the time and date for your radio.

Settings:

- The default time setting is a 12-hour clock. The display shows `12:00AM`.

- The AM/PM selection is not available for the 24-hour clock setting.
- The default setting for the domestic date shows MDY.

**NOTICE:**

Check with your dealer or system administrator for additional programmable settings for this feature.

Editing the Time and Date

1 ◀ or ▶ to Clck.

2 Press the **Menu Select** button directly below Clck.
The display shows the current setting of the radio.

3 Press the **Menu Select** button directly below Edit.
The first item blinks.

4 Perform one of the following actions:

- ▲ or ▼ to change the selected item.
- ◀ or ▶ one or more times to move to an item you wish to change. ▲ or ▼ to change the selected item.

- Press the **Menu Select** button directly below Exit to exit the screen without making any changes and return to the Home screen.
-

5 Perform one of the following actions:

- Press the **Menu Select** button directly below Ok once you have finished to save your changes and return to the Home screen.
- Press the **Menu Select** button directly below Cncl to discard all changes and return to the Home screen.

Press  at any time to return to the Home screen without saving your changes.

**NOTICE:**

If a call arrives while the radio is in the clock-setting menu, the radio exits clock setting and displays the call information. Any changes made before the call is **not** saved.

Using Conventional Squelch Operation Features

This feature filters out unwanted calls with low signal strength or channels that have a higher than normal background noise.

Analog Options

Tone Private Line (PL), Digital Private-Line (DPL), and carrier squelch can be available (preprogrammed) per channel.

Mode	Result
Carrier squelch (C)	You hear all traffic on a channel.
PL or DPL	The radio responds only to your messages.

Digital Options

One or more of the following options may be preprogrammed in your radio. Check with your dealer or system administrator for more information.

Option	Result
Digital Carrier-Operated Squelch (COS)	You hear any digital traffic.
Normal Squelch	You hear any digital traffic having the correct network access code.
Selective Switch	You hear any digital traffic having the correct network access code and correct talkgroup.

Using the PL Defeat Feature

This feature allows you to override any coded squelch (DPL or PL) that might be preprogrammed to a channel. The radio also unmutes to any digital activity on a digital channel.

Place the preprogrammed **PL Defeat** switch in the PL Defeat position.

One of the following scenarios occurs:

- You hear any activity on the channel.
- The radio is muted if no activity is present.

**NOTICE:**

When this feature is active, the Carrier Squelch status indicator is displayed.

If you try to transmit on an active smart-**PTT** channel, you hear an alert tone, and the transmission is inhibited. The LED lights up solid yellow to indicate that the channel is busy.

The following table shows the variations of smart **PTT**:

Digital PTT ID Support

This feature allows you to see the radio ID (number) of the radio from whom you are currently receiving a transmission. This ID, consisting up to a maximum of eight characters, can be viewed by both the receiving radio and the dispatcher.

The ID number of your radio is also automatically sent every time the **PTT** button is pressed. This is a per-channel feature. For digital voice transmissions, the ID of your radio is sent continuously during the voice message.

Smart PTT Feature (Conventional Only)

Smart **PTT** is a per-personality, programmable feature used in conventional radio systems to keep radio users from talking over other radio conversations.

When smart **PTT** is enabled in your radio, you cannot transmit on an active channel.

Mode	Description
Transmit Inhibit on Busy Channel with Carrier	You cannot transmit if any traffic is detected on the channel.
Transmit Inhibit on Busy Channel with Wrong Squelch Code	You cannot transmit on an active channel with a squelch code or (if secure-equipped) encryption key other than your own. If the PL code is the same as yours, the transmission is not prevented.
Quick-Key Override	Your radio must be preprogrammed to allow you to use Quick-Key Override. This feature can work in conjunction with either of the two above variations. You can override the transmit-inhibit state by quick-keying the radio. In other words,

Mode	Description
	two PTT button presses within the preprogrammed time limit.

**NOTICE:**

Acknowledgment of any messages required from the radio is not transmitted if the Transmit Inhibition is enabled.

Transmit Inhibit

This feature is available for APCO 25 trunking, Type II trunking and Conventional operations for all APX radios.

When Transmit Inhibit feature is enabled, the radio stops all transmission including voice and data. The radio can receive messages but is not able to reply the acknowledgment request of the received message.

User can physically control the transmission of the radio especially during operation in hazardous environments with this feature. An environment is considered hazardous when the power emitted by the radio power amplifier could initiate an explosion or other dangerous reactions.

When the Transmit Inhibit feature is disabled, the radio functions according to its normal operations.

The radio sounds alert tone when user enters or exits this feature and also when **PTT** is pressed.

Enabling Transmit Inhibition

Perform one of the following actions:

- Switch the preprogrammed Transmit Inhibit switch to Transmit Inhibit enabled.
- ◀ or ▶ to TxIn. Press the **Menu Select** button below TxIn.
- Press the **Transmit Inhibit** programmable button.

**NOTICE:**

If the user has disabled TX Inhibit using the menu and then moves the switch to the position where TX Inhibit is enabled, the new value overwrites the menu value.

The display shows Tx inhibit on. You hear a sequence of short, low-high tones to indicate transmission is inhibited.

Pressing **PTT** triggers the radio sounds a constant short, low-pitched tone (reject tone).

**NOTICE:**

The status of the Transmit Inhibit does not change after the radio powers up.

Disabling Transmit Inhibition

Perform one of the following actions:

- Switch the preprogrammed Transmit Inhibit switch to Transmit Inhibit disabled position.
- ◀ or ▶ to TxIn. Press the **Menu Select** button below TxIn.
- Press the Transmit Inhibit programmable button.

**NOTICE:**

If the user has disabled TX Inhibit using the softkey and then moves the switch to the position where TX Inhibit is enabled, the new value overwrites the menu value.

The display shows Tx inhibit off. You hear a sequence of short, high-low tone (Transmit Inhibit Off tone) to indicate transmission is back to normal operation.

Instant Recall

This feature allows the user to save the last received call and playback the recorded call.

The feature buffers all incoming audio over the air and stored when the audio is saved.

Saving and Playback Calls

Perform one of the following to save and playback the recorded calls. You can use the options interchangeably

depending on your preference and the programmed functions.

- Playback and saving the recorded calls using the radio menu:
 - a. Press the **Menu Select** button directly below **Rcnt**.
 - b. ▲ or ▼ to **Recent Convs** and press the **Menu Select** button directly below **Sel** to view the recent conversations.
 - c. ▲ or ▼ to the required call and press the **Menu Select** button directly below **Play**.
Radio playback the selected call and auto playback the recorded calls in chronological order.
 - d. Press the **Menu Select** button directly below **Stop** to stop the radio playback.
 - e. ▲ or ▼ to the required call and press the **Menu Select** button directly below **Save**.
Radio displays **Audio Saved** momentarily.
 - f. To return to the previous screen, press the **Menu Select** button directly below **Back**.

- g. To return to the Home screen, press the **Menu Select** button directly below **Exit**.

Recent calls are lost after radio power cycle if the calls are not saved.

- Playback the saved calls using the radio menu:
 - a. Press the **Menu Select** button directly below **Rcnt**.
 - b. ▲ or ▼ to **Saved Convs** and press the **Menu Select** button directly below **Sel** to view the recent conversations.
 - c. ▲ or ▼ to the required call and press the **Menu Select** button directly below **Play**.
Radio playback the selected call and auto playback the saved calls in chronological order.
 - d. Press the **Menu Select** button directly below **Stop** to stop the radio playback.
 - e. To return to the previous screen, press the **Menu Select** button directly below **Back**.
 - f. To return to the Home screen, press the **Menu Select** button directly below **Exit**.
- Saving the recorded calls using the preprogrammed **Record Playback** button:

- a. Long press the preprogrammed **Record Playback** button to save the recorded calls.

Radio displays `Audio Saved` momentarily.

Radio plays the saved call automatically if call saving is successful.

A tone sounds if call saving is not successful.

- Playback the saved calls using the preprogrammed **Record Playback** button:

- a. Short press the preprogrammed **Record Playback** button to playback the saved calls.

- b. Short press the preprogrammed **Record Playback** button again to skip to the next saved call. If there is only a single saved call, the playback skips to the end of the call.

Radio auto playback the most recent incoming call followed by saved calls in chronological order.

Radio displays the playback status.



NOTICE:

Received call overwrites the ongoing record playback. User can short press the programmable button within three seconds to continue the playback and ignore the receiving call.

User can short press the programmable button to trigger playback when the radio is receiving call to overwrite the receiving call.

Playback can be halted by any tone and button press except for specific buttons. Check with your dealer or system administrator for more information.

IMPRES Battery Annunciator

This feature displays the current capacity and charges cycles of your battery when an IMPRES Battery is powering your radio. This feature must be enabled in your radio to see the information.

The information shown are:

Charge Percentage

Percentage of current battery capacity.

Remaining Capacity

Remaining power of the battery in mAh.

Estimated Charges

Number of charges cycles the battery has gone through.

Accessing the Battery Info screen

1 ◀ or ▶ to **Batt.**

2 Press the **Menu Select** button directly below **Batt.**
The display shows the details of the battery.

3 To return to the Home screen, press the **Menu Select** button directly below **Exit.**

General Radio Information

Your radio contains information on the following:

- Radio Information
- IP Display
- Control Assignments

- Soft ID (If enabled)



NOTICE:

The radio automatically exits the feature, if the feature inactivity timer is enabled, when the radio is left idle and the timer expires. You hear the Menu Inactive Exit Tone upon feature exit.

Accessing the Radio Information





This feature displays the following radio information:



- Host Version
- Secure Version
- Model Number
- ESN
- Flash Code
- Tuning Version
- Bluetooth Address
- Expansion Board Type
- DSP Version
- KG (Secure Algorithm)
- Serial Number

- Flash Size and Type
- RF Band(s)
- Processor Version
- Language Pack ID and Version (only when the language of the display is set to non-English)
- MAC Address
- Secure HW Type
- Secure HW Version

**NOTICE:**

To return to the Home screen, press  at any time.

- 1 Perform one of the following actions:
 - Press the preprogrammed **Info** button.
 -  or  to **Info** and press the **Menu Select** button directly below **Info**.
-
- 2  or  to **Radio Info** and press the **Menu Select** button directly below **Sel**.
The display shows the Information screen.
-
- 3 Perform one of the following actions:





-  or  to scroll through the various information.
- To return to the previous screen, press the **Menu Select** button directly below **Back**.
- Press  to return to the Home screen .

Viewing the IP Information

This feature displays the device name, IP address, and status of your radio.

**NOTICE:**

The device name of your radio is preprogrammed. Check with your dealer or system administrator for more information.

- 1 Perform one of the following actions:
 - Press the preprogrammed **Info** button.
 -  or  to **Info** and press the **Menu Select** button directly below **Info**.
-
- 2  or  to **IP Info** and press the **Menu Select** button directly below **Sel**.
The display shows the IP Info screen.

- 3 Perform one of the following actions:
 - ▲ or ▼ to scroll through the various information.
 - Press the **Menu Select** button directly below **Back** to return to the previous screen.
 - Press  to return to the Home screen.
-

Viewing the Control Assignments

This feature displays the programmable radio functions assigned to the controls of your radio for the currently selected channel.

See [Programmable Features on page 35](#) for more information on the various programmable features of your radio.

- 1 Perform one of the following actions:
 - Press the preprogrammed **Info** button.
 - ◀ or ▶ to **Info** and press the **Menu Select** button directly below **Info**.
-

- 2 ▲ or ▼ to **Control map** and press the **Menu Select** button directly below **Se1**.

The display shows the Control Map screen.

- 3 Perform one of the following actions:
 - ▲ or ▼ to scroll through the various information.
 - Press the **Menu Select** button directly below **Back** to return to the previous screen.
 - Press  to return to the Home screen.
-

Editing the Soft ID

Your radio must be preprogrammed to allow you to use this feature.

This feature allows you to change your username.

- 1 Perform one of the following actions:
 - Press the preprogrammed **Info** button.
 - ◀ or ▶ to **Info** and press the **Menu Select** button directly below **Info**.
-

- 2 ▲ or ▼ to Soft ID and press the **Menu Select** button directly below `Sel`.

The display shows the current Soft ID.

- 3 Perform one of the following actions:

- Press the **Menu Select** button directly below `Edit` to edit the current Soft ID.
- Press the **Menu Select** button directly below `Back` to return to the previous screen.

A blinking cursor appears in the Edit Soft ID screen.

- 4 Use the keypad to edit the text.
-

- 5 Perform one of the following actions:

- Press the **Menu Select** button directly below `Ok` to save the new Soft ID and return to the previous screen.
 - Press the **Menu Select** button directly below `Cnc1` to return to the previous screen.
-

Front Panel Programming

You are able to customize certain feature parameters in Front Panel Programming (FPP) to enhance the use of your radio.

Entering the Front Panel Programming Mode

You can follow this procedure to enter the front panel programming (FPP) mode on your radio.

Federal

- 1 Press ◀ or ▶ to FPP and press the **Menu Select** button directly below `FPP`.

The radio displays the `Enter password` screen.

- 2 Perform one of the following actions and proceed to the next step:
- Press the **Menu Select** button directly below `Ok`.
 - Enter the password and press the **Menu Select** button directly below `Ok`.

If the password is not entered, the radio displays the non-password protected zones only.

3 Press ▲ or ▼ to select Zn/Ch.

4 Press ▲ or ▼ to select the required zone.

5 Press ▲ or ▼ to select the required channel.
The display shows the radio parameter screen.

6 Press ▲ or ▼ to select the required parameter to edit.

Non-Federal

1 Press ◀ or ▶ to FPP and press the **Menu Select** button directly below FPP.
The radio displays the Enter password screen

2 Enter the password and press the **Menu Select** button directly below Ok.

3 Press ▲ or ▼ to select Zn/Ch.

4 Press ▲ or ▼ to select the required zone.

5 Press ▲ or ▼ to select the required channel.
The display shows the radio parameter screen.

6 Press ▲ or ▼ to select the required parameter to edit.

Editing FPP Mode Parameters

Perform the following actions as required while navigating through the feature parameters.

- Press ▲ or ▼ to scroll through options or navigate vertically.
- Press the **Menu Select** button directly below Edit to edit the parameter values.
- Press the **Back** button to return to the previous screen.

Helpful Tips

This chapter explains the radio and battery care.

Battery Care

This chapter provides information on the battery charge status, battery recycling and disposal.

Battery Charge Status

Your radio can indicate the battery's charge status through:

- the LED and sounds.
- the fuel gauge icon on the display.

You can also check the battery charge status using the menu entry. See [IMPRES Battery Annunciator on page 203](#) for more information.

LED and Sounds



When your battery is low:

- the LED blinks red when the **PTT** button is pressed.







- you hear a low-battery “chirp” (short, high-pitched tone).

Fuel Gauge Icons

A blinking fuel gauge icon () is displayed only when the battery voltage drops to low level. In this case, replace the battery with a fully charged one.

Gauge	Battery Charge
	76% to 100% full ³
Top Display: 	
	51% to 75% ³
Top Display:	

³ These are for IMPRES battery operation only.

Gauge	Battery Charge
	
	26% to 50% ³
Top Display: 	
	11% to 25% ³
Top Display: 	
	10% or less (at 10%, the gauge begins blinking)
Top Display:	

Gauge	Battery Charge
	

Battery Recycling and Disposal

In the U.S. and Canada, Motorola Solutions participates in the nationwide Call2Recycle program for battery collection and recycling. Many retailers and dealers participate in this program.

For the location of the drop-off facility closest to you, access Call2Recycle's Internet web site at <http://www.call2recycle.org/> or call 1-800-8-BATTERY. This internet site and telephone number also provide other useful information concerning recycling options for consumers, businesses, and governmental agencies.

Accessories

The accessory link below is for APX radios. Not all accessories are FCC certified to operate with all APX models and/or bandsplits. Refer to the specific APX radio price pages for a list of FCC certified accessories or contact your sales representative for accessory compatibility.

<http://www.motorolasolutions.com>

Maritime Radio Use in the VHF Frequency Range

Special Channel Assignments

Emergency Channel

If you are in imminent and grave danger at sea and require emergency assistance, use VHF Channel 16 to send a distress call to nearby vessels and the United States Coast Guard. Transmit the following information, in this order:

- 1 "MAYDAY, MAYDAY, MAYDAY."
- 2 "THIS IS _____, CALL SIGN _____." State the name of the vessel in distress 3 times, followed by the call sign or other identification of the vessel, stated 3 times.
- 3 Repeat "MAYDAY" and the name of the vessel.
- 4 "WE ARE LOCATED AT _____." State the position of the vessel in distress, using any information that will help responders to locate you, e.g.:
 - latitude and longitude

- bearing (state whether you are using true or magnetic north)
 - distance to a well-known landmark
 - vessel course, speed or destination
- 5 State the nature of the distress.
 - 6 Specify what kind of assistance you need.
 - 7 State the number of persons on board and the number needing medical attention, if any.
 - 8 Mention any other information that would be helpful to responders, such as type of vessel, vessel length and/or tonnage, hull color, etc.
 - 9 "OVER."
 - 10 Wait for a response.
 - 11 If you do not receive an immediate response, remain by the radio and repeat the transmission at intervals until you receive a response. Be prepared to follow any instructions given to you.

Non-Commercial Call Channel

For non-commercial transmissions, such as fishing reports, rendezvous arrangements, repair scheduling, or berthing information, use **VHF Channel 9**.

Operating Frequency Requirements

A radio designated for shipboard use must comply with Federal Communications Commission Rule Part 80 as follows:

- on ships subject to Part II of Title III of the Communications Act, the radio must be capable of operating on the 156.800 MHz frequency.
- on ships subject to the Safety Convention, the radio must be capable of operating:
 - in the simplex mode on the ship station transmitting frequencies specified in the 156.025–157.425 MHz frequency band, and
 - in the semiduplex mode on the two frequency channels specified in the table below.



NOTICE:

Simplex channels 3, 21, 23, 61, 64, 81, 82, and 83 cannot be lawfully used by the general public in US waters.

Additional information about operating requirements in the Maritime Services can be obtained from the full text of FCC Rule Part 80 and from the US Coast Guard.

Table 1: VHF Marine Channel List

Channel Number	Frequency (MHz)	
	Transmit	Receive
1	156.050	160.650
2	156.100	160.700
*	156.150	160.750
4	156.200	160.800
5	156.250	160.850
6	156.300	–
7	156.350	160.950
8	156.400	–
9	156.450	156.450
10	156.500	156.500
11	156.550	156.550
12	156.600	156.600
13**	156.650	156.650
14	156.700	156.700
15**	156.750	156.750

16	156.800	156.800
17**	156.850	156.850
18	156.900	161.500
19	156.950	161.550
20	157.000	161.600
*	157.050	161.650
22	157.100	161.700
*	157.150	161.750
24	157.200	161.800
25	157.250	161.850
26	157.300	161.900
27	157.350	161.950
28	157.400	162.000
60	156.025	160.625
*	156.075	160.675
62	156.125	160.725
63	156.175	160.775
*	156.225	160.825

65	156.275	160.875
66	156.325	160.925
67**	156.375	156.375
68	156.425	156.425
69	156.475	156.475
71	156.575	156.575
72	156.625	–
73	156.675	156.675
74	156.725	156.725
75	***	***
76	***	***
77**	156.875	–
78	156.925	161.525
79	156.975	161.575
80	157.025	161.625
*	157.075	161.675
*	157.125	161.725
*	157.175	161.775

84	157.225	161.825
85	157.275	161.875
86	157.325	161.925
87	157.375	161.975
88	157.425	162.025

use when it operates on the distress and safety frequencies specified in RSS-182 Section 7.3.

Technical Parameters for Interfacing External Data Sources

	RS232	USB	SB9600
Input Voltage (Volts Peak-to-peak)	18 V	3.6 V	5 V
Max Data Rate	115 Kbps	12 Mbps	9.6 Kbps
Impedance	5000 Ω	90 Ω	120 Ω



NOTICE:

* *Simplex channels 3, 21, 23, 61, 64, 81, 82, and 83 cannot be **lawfully used** by the general public in US waters.*

** *Low power (1 W) only.*

*** *Guard band.*



NOTICE:

A – in the Receive column indicates that the channel is transmit only.

Declaration of Compliance for the Use of Distress and Safety Frequencies

The radio equipment does not employ a modulation other than the internationally adopted modulation for maritime

Glossary

This glossary contains an alphabetical listing of terms and their definitions that are applicable to portable and mobile subscriber radio products.

ACK

Acknowledgment of communication.

Active Channel

A channel that has traffic on it.

Analog Signal

An RF signal that has a continuous nature rather than a pulsed or discrete nature.

ARS

Automatic Registration Service

ASTRO 25

Motorola Solutions standard for wireless digital trunked communications.

ASTRO conventional

Motorola Solutions standard for wireless analog or digital conventional communications.

Autoscan

A feature that allows the radio to automatically scan the members of a scan list.

Bluetooth

Bluetooth is an open wireless technology standard for exchanging data over short distances from fixed and mobile devices with high levels of security.

Bluetooth Pairing

Bluetooth pairing occurs when two bluetooth devices exchanged a passkey to form a paired Bluetooth wireless connection.

Call Alert

Privately paging an individual by sending an audible tone.

Carrier Squelch

Feature that responds to the presence of an RF carrier by opening or unmuting (turning on) a receiver audio circuit. A squelch circuit silences the radio when no signal is being received so that the user does not have to listen to “noise.”

Central Controller

A software-controlled, computer-driven device that receives and generates data for the trunked radios assigned to it. It monitors and directs the operations of the trunked repeaters.

Channel

A group of characteristics, such as transmit/receive frequency pairs, radio parameters, and encryption encoding.

Control Channel

In a trunking system, one of the channels that is used to provide a continuous, two-way/data-communications path between the central controller and all radios on the system.

Conventional

Typically refers to radio-to-radio communications, sometimes through a repeater. Frequencies are shared

with other users without the aid of a central controller to assign communications channels.

Conventional Scan List

A scan list that includes only conventional channels.

COTS

Commercial Off-The-Shelf.

Cursor

A visual tracking marker (a blinking line) that indicates a location on a display.

Deadlock

Displayed by the radio after three failed attempts to unlock the radio. The radio must be powered off and on prior to another attempt.

Digital Private Line

A type of digital communications that utilizes privacy call, as well as memory channel and busy channel lock out to enhance communication efficiency.

Digital Signal

An RF signal that has a pulsed, or discrete, nature, rather than a continuous nature.

Dispatcher

An individual who has radio-system management duties and responsibilities.

Digital Signal Processor

A microcontroller specifically designed for performing the mathematics involved in manipulating analog information, such as sound, that has been converted into a digital form. DSP also implies the use of a data compression technique.

Dynamic Regrouping

A feature that allows the dispatcher to temporarily reassign selected radios to a single special channel so they can communicate with each other.

DSR

Dynamic System Resilience.

EID

Encrypted Integrated Data.

ESN

Electrical Serial Number.

Failsoft

A backup system that allows communication in a non-trunked, conventional mode if the trunked system fails.

FCC

Federal Communications Commission.

Hang up

Disconnect.

IV&D

Integrated Voice and Data.

Key Variable Loader (KVL) A portable, handheld, rugged device used to transfer encryption keys to a target device. Encryption keys can be entered manually by the KVL user, auto-generated by the KVL, obtained from or

shared with another KVL, or downloaded from a Key Management Facility (KMF).

Liquid-Crystal Display (LCD)

An LCD uses two sheets of polarizing material with a liquid-crystal solution between them. An electric current passed through the liquid causes the crystals to align so that light cannot pass through them.

Light Emitting Diode (LED)

An electronic device that lights up when electricity is passed through it.

Li-Ion

Lithium ion.

Man Down

A life-saving feature that senses the radio user may be in trouble by monitoring the whether the radio is in a vertical or horizontal position or whether the radio is motionless. When this feature is triggered, the radio alerts the user with audio and visual alerts. It can also trigger Emergency Alarm the Post-Alert Timer is not cancelled.

MCW

Mission Critical Wireless.

MDC

Motorola Solutions Digital Communications.

Menu Entry

A software-activated feature shown at the bottom of the display. Selection of a feature is controlled by the programming of the buttons on the side of the radio.

Monitor

Check channel activity by pressing the Monitor button. If the channel is clear, you hear static. If the channel is in use, you hear conversation. It also serves as a way to check the volume level of the radio, since the radio “opens the squelch” when the monitor button is pressed.

Multi-System Talkgroup Scan List

A scan list that can include both talkgroups (trunked) and channels (conventional).

Network Access Code

Network Access Code (NAC) operates on digital channels to reduce voice channel interference between adjacent systems and sites.

NiMH

Nickel-metal-hydride.

Non-tactical/revert

The user will talk on a preprogrammed emergency channel. The emergency alarm is sent out on this same channel.

OCW

Operation Critical Wireless.

Over-The-Air Rekeying

Allows the dispatcher to remotely reprogram the encryption keys in the radio.

Page

A one-way alert with audio and/or display messages.

Personality

A set of unique features specific to a radio.

PIN

Personal Identification Number.

PremierOne

A software application which streamlines critical real time operations and simplifies system administration to deliver accurate, consistent and integrated information remotely to the requestors.

Preprogrammed

A software feature that has been activated by a qualified radio technician.

Private (Conversation) Call

A feature that lets you have a private conversation with another radio user in the group.

Private Line (PL)

A sub-audible tone that is transmitted such that only receivers decoding the tone receives it.

Programmable

A radio control that can have a radio feature assigned to it.

Push-to-Talk

PTT-The switch or button usually located on the left side of the radio which, when pressed, causes the radio to transmit. When the PTT is released, the unit returns to receive operation.

Radio Frequency

RF-The portion of the electromagnetic spectrum between audio sound and infrared light (approximately 10 kHz to 10 GHz).

Repeater

Remote transmit/receive facility that re-transmits received signals in order to improve communications range and coverage (conventional operation).

Selective Call

A feature that allows you to call a selected individual, intended to provide privacy and to eliminate the annoyance of having to listen to conversations of no interest to you.

selective switch

Any digital P25 traffic having the correct Network Access Code and the correct talkgroup.

Squelch

Muting of audio circuits when received signal levels fall below a pre-determined value. With carrier squelch, all channel activity that exceeds the preset squelch level can be heard.

Synchronous Serial Interface (SSI)

DSP interface to peripherals that consists of a clock signal line, a frame synchronization signal line, and a data line.

Standby

An operating condition whereby the radio's speaker is muted but still continues to receive data.

Status Calls

Pre-defined text messages that allow the user to send a conditional message without talking.

Tactical/non-revert

The user will talk on the channel that was selected before the radio entered the emergency state.

TalkAround

Bypassing a repeater and talking directly to another unit for local unit-to-unit communications.

Talkgroup

An organization or group of radio users who communicate with each other using the same communications path.

TMS

Text Messaging Service.

Trunking

The automatic sharing of communications paths between a large number of users. Allows users to share a smaller number of frequencies because a repeater or communications path is assigned to a talkgroup for the duration of a conversation.

Trunking Priority Monitor scan list

A scan list that includes talkgroups that are all from the same trunking system.

USK

Unique shadow key.

UTC

Coordinated Universal Time. The international time standard (formerly Greenwich Mean Time, or GMT). Zero hours UTC is midnight in Greenwich, England, which is located at 0 degrees longitude. Everything east of Greenwich (up to 180 degrees) is later in time; everything west is earlier. There are 42 time authorities around the world that are constantly synchronizing with each other. Abbreviated as UTC (English backronym = Universal Time, Coordinated), it is also known as Zulu (Z) Time.

VRS

Vehicular Repeater System.

Zone

A grouping of channels.

Limited Warranty

MOTOROLA SOLUTIONS COMMUNICATION PRODUCTS

I. WHAT THIS WARRANTY COVERS AND FOR HOW LONG:

MOTOROLA SOLUTIONS, INC. (“MOTOROLA”) warrants the MOTOROLA SOLUTIONS manufactured Communication Products listed below (“Product”) against defects in material and workmanship under normal use and service for a period of time from the date of purchase as scheduled below:

ASTRO APX 8000H Portable Units	One (1) Year
Product Accessories	One (1) Year

For LACR region:

ASTRO APX 8000H Portable Units	Three (3) Years
Product Accessories	One (1) Year

MOTOROLA SOLUTIONS, at its option, will at no charge either repair the Product (with new or reconditioned parts), replace it (with a new or reconditioned Product), or refund the purchase price of the Product during the warranty period provided it is returned in accordance with the terms of this warranty. Replaced parts or boards are warranted for the balance of the original applicable warranty period. All replaced parts of Product shall become the property of MOTOROLA SOLUTIONS.

This express limited warranty is extended by MOTOROLA SOLUTIONS to the original end user purchaser only and is not assignable or transferable to any other party. This is the complete warranty for the Product manufactured by MOTOROLA SOLUTIONS. MOTOROLA SOLUTIONS assumes no obligations or liability for additions or modifications to this warranty unless made in writing and signed by an officer of MOTOROLA SOLUTIONS.

Unless made in a separate agreement between MOTOROLA SOLUTIONS and the original end user purchaser, MOTOROLA SOLUTIONS does not warrant the installation, maintenance or service of the Product.

MOTOROLA SOLUTIONS cannot be responsible in any way for any ancillary equipment not furnished by MOTOROLA SOLUTIONS which is attached to or used in connection with the Product, or for operation of the Product with any ancillary equipment, and all such equipment is expressly excluded from this warranty. Because each system which may use the Product is unique, MOTOROLA SOLUTIONS disclaims liability for range, coverage, or operation of the system as a whole under this warranty.

MOTOROLA SOLUTIONS offers the following optional extended service contracts.

SERVICE FROM THE START (SfS) COMPREHENSIVE

Provides for extended hardware repair coverage INCLUDING CHEMICAL, LIQUID, FIRE, AND OTHER PHYSICAL DAMAGE. Comprehensive coverage is available in conjunction with MOTOROLA SOLUTIONS'S standard Commercial Warranty and starts from the FIRST DAY the radio is put into use. Service performed under this plan consists of repair or replacement of the covered equipment as set forth in the terms and conditions. Repairs will be made only at the designated MOTOROLA SOLUTIONS repair depot. Local services are not included. MOTOROLA SOLUTIONS will pay the inbound shipping charges only with use of the MOTOROLA SOLUTIONS designated delivery service. MOTOROLA SOLUTIONS will

pay for outbound shipping via MOTOROLA SOLUTIONS'S normal shipping methods.

SERVICE FROM THE START (SfS) LITE

Provides extended hardware normal wear and tear repair coverage beginning AFTER MOTOROLA SOLUTIONS'S standard Commercial Warranty period expires. Service performed under this plan consists of repair of the covered equipment as set forth in the terms and conditions. Repairs will be made only at the designated MOTOROLA SOLUTIONS repair depot. Local services are not included. MOTOROLA SOLUTIONS will pay for outbound shipping via MOTOROLA SOLUTIONS'S normal shipping methods.

II. GENERAL PROVISIONS:

This warranty sets forth the full extent of MOTOROLA SOLUTIONS'S responsibilities regarding the Product. Repair, replacement or refund of the purchase price, at MOTOROLA SOLUTIONS's option, is the exclusive remedy. THIS WARRANTY IS GIVEN IN LIEU OF ALL OTHER EXPRESS WARRANTIES. IMPLIED WARRANTIES, INCLUDING WITHOUT LIMITATION, IMPLIED WARRANTIES OF MERCHANTABILITY AND FITNESS FOR A PARTICULAR PURPOSE, ARE LIMITED TO THE DURATION OF THIS LIMITED WARRANTY. IN NO EVENT SHALL MOTOROLA SOLUTIONS BE LIABLE

FOR DAMAGES IN EXCESS OF THE PURCHASE PRICE OF THE PRODUCT, FOR ANY LOSS OF USE, LOSS OF TIME, INCONVENIENCE, COMMERCIAL LOSS, LOST PROFITS OR SAVINGS OR OTHER INCIDENTAL, SPECIAL OR CONSEQUENTIAL DAMAGES ARISING OUT OF THE USE OR INABILITY TO USE SUCH PRODUCT, TO THE FULL EXTENT SUCH MAY BE DISCLAIMED BY LAW.

III. STATE LAW RIGHTS:

SOME STATES DO NOT ALLOW THE EXCLUSION OR LIMITATION OF INCIDENTAL OR CONSEQUENTIAL DAMAGES OR LIMITATION ON HOW LONG AN IMPLIED WARRANTY LASTS, SO THE ABOVE LIMITATION OR EXCLUSIONS MAY NOT APPLY.

This warranty gives specific legal rights, and there may be other rights which may vary from state to state.

IV. HOW TO GET WARRANTY SERVICE:

You must provide proof of purchase (bearing the date of purchase and Product item serial number) in order to receive warranty service and, also, deliver or send the

Product item, transportation and insurance prepaid, to an authorized warranty service location. Warranty service will be provided by MOTOROLA SOLUTIONS through one of its authorized warranty service locations. If you first contact the company which sold you the Product (e.g., dealer or communication service provider), it can facilitate your obtaining warranty service. You can also call MOTOROLA SOLUTIONS at 1-800-927-2744 US/Canada.

V. WHAT THIS WARRANTY DOES NOT COVER:

- 1 Defects or damage resulting from use of the Product in other than its normal and customary manner.
- 2 Defects or damage from misuse, accident, water, or neglect.
- 3 Defects or damage from improper testing, operation, maintenance, installation, alteration, modification, or adjustment.
- 4 Breakage or damage to antennas unless caused directly by defects in material workmanship.
- 5 A Product subjected to unauthorized Product modifications, disassembles or repairs (including, without limitation, the addition to the Product of non-

MOTOROLA SOLUTIONS supplied equipment) which adversely affect performance of the Product or interfere with MOTOROLA SOLUTIONS's normal warranty inspection and testing of the Product to verify any warranty claim.

- 6 Product which has had the serial number removed or made illegible.
- 7 Rechargeable batteries if:
 - any of the seals on the battery enclosure of cells are broken or show evidence of tampering.
 - the damage or defect is caused by charging or using the battery in equipment or service other than the Product for which it is specified.
- 8 Freight costs to the repair depot.
- 9 A Product which, due to illegal or unauthorized alteration of the software/firmware in the Product, does not function in accordance with MOTOROLA SOLUTIONS's published specifications or the FCC certification labeling in effect for the Product at the time the Product was initially distributed from MOTOROLA SOLUTIONS.
- 10 Scratches or other cosmetic damage to Product surfaces that does not affect the operation of the Product.

11 Normal and customary wear and tear.

VI. PATENT AND SOFTWARE PROVISIONS:

MOTOROLA SOLUTIONS will defend, at its own expense, any suit brought against the end user purchaser to the extent that it is based on a claim that the Product or parts infringe a United States patent, and MOTOROLA SOLUTIONS will pay those costs and damages finally awarded against the end user purchaser in any such suit which are attributable to any such claim, but such defense and payments are conditioned on the following:

- 1 that MOTOROLA SOLUTIONS will be notified promptly in writing by such purchaser of any notice of such claim,
- 2 that MOTOROLA SOLUTIONS will have sole control of the defense of such suit and all negotiations for its settlement or compromise, and
- 3 should the Product or parts become, or in MOTOROLA SOLUTIONS's opinion be likely to become, the subject of a claim of infringement of a United States patent, that such purchaser will permit MOTOROLA SOLUTIONS, at its option and expense, either to procure for such purchaser the right to continue using the Product or parts or to replace or modify the same so that it

becomes non-infringing or to grant such purchaser a credit for the Product or parts as depreciated and accept its return. The depreciation will be an equal amount per year over the lifetime of the Product or parts as established by MOTOROLA SOLUTIONS.

MOTOROLA SOLUTIONS will have no liability with respect to any claim of patent infringement which is based upon the combination of the Product or parts furnished hereunder with software, apparatus or devices not furnished by MOTOROLA SOLUTIONS, nor will MOTOROLA SOLUTIONS have any liability for the use of ancillary equipment or software not furnished by MOTOROLA SOLUTIONS which is attached to or used in connection with the Product. The foregoing states the entire liability of MOTOROLA SOLUTIONS with respect to infringement of patents by the Product or any parts thereof.

Laws in the United States and other countries preserve for MOTOROLA SOLUTIONS certain exclusive rights for copyrighted MOTOROLA SOLUTIONS software such as the exclusive rights to reproduce in copies and distribute copies of such MOTOROLA SOLUTIONS software. MOTOROLA SOLUTIONS software may be used in only the Product in which the software was originally embodied and such software in such Product may not be replaced, copied, distributed, modified in any way, or used to produce any derivative thereof. No other use including, without

limitation, alteration, modification, reproduction, distribution, or reverse engineering of such MOTOROLA SOLUTIONS software or exercise of rights in such MOTOROLA SOLUTIONS software is permitted. No license is granted by implication, estoppel or otherwise under MOTOROLA SOLUTIONS patent rights or copyrights.

VII. GOVERNING LAW:

This Warranty is governed by the laws of the State of Illinois, U.S.A.

VIII. For Australia Only

This warranty is given by Motorola Solutions Australia Pty Limited (ABN 16 004 742 312) of Tally Ho Business Park, 10 Wesley Court. Burwood East, Victoria.

Our goods come with guarantees that cannot be excluded under the Australia Consumer Law. You are entitled to a replacement or refund for a major failure and compensation for any other reasonably foreseeable loss or damage. You are also entitled to have the goods repaired or replaced if the goods fail to be of acceptable quality and the failure does not amount to a major failure.

Motorola Solutions Australia's limited warranty above is in addition to any rights and remedies you may have under the Australian Consumer Law. If you have any queries, please call Motorola Solutions Australia at 1800 457 439. You may also visit our website: http://www.motorolasolutions.com/XA-EN/Pages/Contact_Us for the most updated warranty terms.