

# RPX Repeater Series™

*Installation and User Guide*



Model RPU2160



## **Document Copyrights**

No duplication or distribution of this document or any portion thereof shall take place without the express written permission of Motorola. No part of this manual may be reproduced, distributed, or transmitted in any form or by any means, electronic or mechanical, for any purpose without the express written permission of Motorola.

## **Disclaimer**

The information in this document is carefully examined, and is believed to be entirely reliable. However, no responsibility is assumed for inaccuracies. Furthermore, Motorola reserves the right to make changes to any products herein to improve readability, function, or design. Motorola does not assume any liability arising out of the applications or use of any product or circuit described herein; nor does it cover any license under its patent rights nor the rights of others.

# CONTENTS

<b>Computer Software</b>	
<b>Copyrights</b> . . . . .	<b>iv</b>
<b>Radio Frequency (RF)</b>	
<b>Exposure Safety Standards</b> . . . . .	<b>v</b>
Operational Safety Guidelines. . . . .	vi
<b>FCC Licensing Information</b> . . . . .	<b>viii</b>
Interference Information . . . . .	viii
<b>Introduction</b> . . . . .	<b>1</b>
Package Contents . . . . .	1
About This Manual . . . . .	2
Service Support. . . . .	2
Product Safety. . . . .	2
Manual Revisions . . . . .	2
Acronyms . . . . .	2
<b>Repeater Overview</b> . . . . .	<b>3</b>
Parts of the Repeater . . . . .	3
Repeater Accessories. . . . .	5
How the Repeater Works . . . . .	8

<b>Pre-Installation Considerations</b> . . . . .	<b>10</b>
RF Coverage Field Test. . . . .	10
Choosing a Tentative Location . . . . .	11
Conducting the RF Coverage	
Field Test. . . . .	12
Environmental Conditions at	
Intended Installation Site (*). . . . .	13
Temperature Ranges. . . . .	14
Ventilation . . . . .	14
Electrical Requirements . . . . .	15
AC/DC Power Requirements. . . . .	15
Site Grounding and Lightning	
Protection. . . . .	15
Electrical Ground . . . . .	16
RF Ground . . . . .	16
Lightning Ground . . . . .	16
<b>Repeater Installation</b> . . . . .	<b>17</b>
Installations	
Considerations. . . . .	17
Repeater Positioning and	
Orientation . . . . .	17
Antenna Installation Instructions . . . . .	19

Installing External Antenna		<b>Getting Started</b> . . . . .	<b>33</b>
Using the Antenna/Magnetic		Turning Repeater On/Off . . . . .	33
Mount/RF Cable Kit Accessory . . . . .	21	Repeater Status Led (Front LED) . . . . .	33
RF Cable Installation. . . . .	23	Radio LED Indicators. . . . .	33
Installing Exterior Antenna . . . . .	24	Selecting A Channel. . . . .	35
Uninstalling Exterior Antenna . . . . .	24	Repeater Programming Default	
Wall Mount Installation Instructions . . . . .	24	Values . . . . .	37
AC/DC Power Supply Connection . . . . .	26	<b>Programming The Repeater</b> . . . . .	<b>38</b>
Vehicle Charger . . . . .	27	Programming Features Overview . . . . .	38
Repeater Installation – Example . . . . .	28	Programming the Repeater	
<b>Alkaline Battery Frame</b> . . . . .	<b>29</b>	Using the CPS . . . . .	40
About Alkaline Batteries . . . . .	29	How to Read and Modify	
Alkaline Batteries Frame Solution. . . . .	29	Your Repeater's Features . . . . .	41
Alkaline Battery Life Estimation . . . . .	29	<b>Programming Your Radios</b> . . . . .	<b>43</b>
Alkaline Battery and Power		Programming Your RDX Radios	
Detection LED (Side) . . . . .	30	To Work With The Repeater . . . . .	43
Installing/Removing the Alkaline			
Battery Frame . . . . .	31		
Li-Ion Battery Frame (Optional			
Accessory) . . . . .	32		

<b>Programming Multiple Repeaters</b> . . . . .	<b>46</b>	Battery Accessories (*) . . . . .	61
Setting Up Multiple Repeaters		RDX Pick-Up Radios	
In A Single Location		and Accessories . . . . .	62
(Multiple User Groups) . . . . .	46	Cables Accessories . . . . .	62
<b>Repeater Cloning</b> . . . . .	<b>48</b>	Charger Accessories . . . . .	62
RDX Radio to Repeater Cloning . . . . .	48	<b>Appendix A: Repeater</b>	
Operating Instructions . . . . .	49	<b>Specifications</b> . . . . .	<b>63</b>
Cloning Instructions . . . . .	49	<b>Appendix B: Repeater Lightning</b>	
<b>Troubleshooting</b> . . . . .	<b>52</b>	<b>Protection</b> . . . . .	<b>68</b>
<b>Use and Care</b> . . . . .	<b>55</b>	How To Minimize Lightning	
<b>Motorola Limited Warranty</b>		Damage for RPX Repeater	
<b>for the United States</b> . . . . .	<b>56</b>	Series™ System . . . . .	68
<b>Accessories</b> . . . . .	<b>61</b>	AC Line Requirements: . . . . .	68
RPX Repeater Series Accessories . . . . .	61	RF Protection Instructions: . . . . .	68
Antenna Accessories . . . . .	61		
Batteries Accessories . . . . .	61		
Power Supplies Accessories . . . . .	61		

## COMPUTER SOFTWARE COPYRIGHTS

The Motorola products described in this manual may include copyrighted Motorola computer programs stored in semiconductor memories or other media. Laws in the United States and other countries preserve for Motorola certain exclusive rights for copyrighted computer programs, including, but not limited to, the exclusive right to copy or reproduce in any form the copyrighted computer program. Accordingly, any copyrighted Motorola computer programs contained in the Motorola products described in this manual may not be copied, reproduced, modified, reverse-engineered, or distributed in any manner without the express written permission of Motorola.

Furthermore, the purchase of Motorola products shall not be deemed to grant either directly or by implication, estoppels, or otherwise, any license under the copyrights, patents or patent applications of Motorola, except for the normal non-exclusive license to use that arises by operation of law in the sale of a product.

## RADIO FREQUENCY (RF) EXPOSURE SAFETY STANDARDS



Caution

Before using this product, read the operating instructions and RF energy awareness information contained in the Product Safety and RF Exposure booklet (Motorola P/N 68007024074) enclosed with your radio.

To ensure compliance to RF Energy Safety Standards:

- Install only Motorola approved antennas and accessories
- Be sure that Product Safety and RF Safety Booklet (P/N 68007024074) enclosed with this radio is available to the end user upon completion of the installation of this radio

For a list of Motorola-approved antennas and other accessories, visit the following web site which lists approved accessories for your radio model:  
<http://www.motorola.com/RPX>

## OPERATIONAL SAFETY GUIDELINES

1. Read these instructions.
2. Keep these instructions.
3. Heed all warnings.
4. Follow all instructions.
5. Do not use this apparatus near water.
6. Clean only with a damp cloth.
7. Do not block any of the ventilation openings. Install in accordance with the manufacturer's instructions.
8. Do not install near any heat sources such as radiators, heat registers, stoves, or other apparatus (including amplifiers) that produce heat.
9. Do not defeat the safety purpose of the polarized or grounding-type plug. A polarized plug has two blades with one wider than the other. A grounding type plug has two blades and a third grounding prong. The wide blade or the third prong are provided for your safety. When the provided plug does not fit into your outlet, consult an electrician for replacement of the obsolete outlet.
10. Protect the power cord from being walked on or pinched particularly at plugs, convenience receptacles, and the point where they exit from the apparatus.
11. Use only the attachments/accessories specified by the manufacturer.
12. Mount only on a stable horizontal or vertical surface. Use only with supplied holster if it is mounted on a wall or ceiling.
13. Unplug this apparatus during lightning storms or when unused for long periods of time.
14. Refer all servicing to qualified service personnel. Servicing is required when the apparatus has been damaged in any way, such as power-supply cord or plug is damaged, liquid has been spilled or objects have fallen into the apparatus, the apparatus has been exposed to rain or moisture, does not operate normally, or has been dropped.
15. The power supply is not suitable for outdoor use. Use only in dry locations/conditions.
16. Connect the power supply only to an appropriately fused and wired supply of the correct voltage (as specified on the product).



17. Disconnect the power supply from the line voltage by removing the main plug. The outlet to which this equipment is connected should be nearby and easily accessible.
18. Maximum ambient temperature around the power supply equipment must not exceed 40 °C (104 °F).
19. Make sure that the cord is located where it is not stepped on, tripped over, or subjected to water, damage or stress.

## FCC LICENSING INFORMATION

### INTERFERENCE INFORMATION

This device complies with Part 15 of the FCC Rules. Operation is subject to the condition that this device does not cause harmful interference.

The RPX Repeater Series™ operate on radio frequencies that are regulated by the Federal Communications Commission (FCC). To transmit on these frequencies, you are required to have a license issued by the FCC. Application is made available on FCC Form 601 and Schedules D, H, and Remittance Form 159.

To obtain these FCC forms, request document 000601 which includes all forms and instructions. If you wish to have the document faxed, mailed or have questions, use the following contact information.

<b>Faxed: Contact the Fax-On-Demand system at:</b>	<b>Mailed: Call the FCC forms hotline at:</b>	<b>For questions regarding FCC license, contact the FCC at:</b>
1-202-418-0177	1-800-418-FORM 1-800-418-3676	1-888-CALL-FCC 1-888-225-5322 Or: <a href="http://www.fcc.gov">http://www.fcc.gov</a>

Before filling out your application, you must decide which frequency(ies) you can operate on: “Appendix A: Repeater Specifications” on page 63. For questions on determining the radio frequency, call Motorola Product Services at: **1-800-448-6686**.

Changes or modifications not expressly approved by Motorola may void the user’s authority granted by the FCC to operate this radio and should not be made. To comply with FCC requirements, transmitter adjustments should be made only by or under the supervision of a person certified as technically qualified to perform transmitter maintenance and repairs in the private land mobile and fixed services as certified by an organization representative of the user of those services.

Replacement of any transmitter component (crystal, semiconductor, etc.) not authorized by the FCC equipment authorization for this radio could violate FCC rules.

Use of this radio outside the country where it was intended to be distributed is subject to government regulations and may be prohibited.

## Notes

## INTRODUCTION

Congratulations on your Motorola® RPX Repeater Series™ purchase!

This repeater is a product of Motorola's 80 plus years of experience as a world leader in the designing and manufacturing of communications equipment. The RPX Repeater Series™ provide cost-effective communications for businesses such as retail stores, restaurants, schools, construction sites, manufacturing, property and hotel management and more. Motorola Business Radios and Repeater devices are the perfect communications solution for all of today's fast-paced industries.

**Note:** Read this user guide carefully to ensure you know how to properly operate the repeater before use.

## PACKAGE CONTENTS

Your product package contains the following products and manuals:

- Repeater (includes the Alkaline Battery Frame)
- Antenna
- Power Supply
- Wall holster mount
- User Guide, CD and Quick Reference Leaflet
- Warranty Card
- Product Safety & RF Exposure Booklet

For product information, visit us at:  
[www.motorola.com/radios/business](http://www.motorola.com/radios/business)  
or visit our micro-site at: [www.motorola.com/RPX](http://www.motorola.com/RPX)

For User Guide or product-related questions, contact:

**1-800-448- 6686 in the USA**  
**1-866-522-5210 on your TTY (Text Telephone)**

You can also send mail to us at:

**Business Radios,  
RPSD 1C15, Motorola  
8000 West Sunrise Boulevard  
Plantation, Florida 33322**

## ABOUT THIS MANUAL

This manual contains installation information required for the RPX Repeater Series™ repeater.

## SERVICE SUPPORT

For information related to the service support (including software, replacement parts and accessories for the RPX Repeater Series™), contact your Motorola Authorized Distributors and Resellers via MOL (Motorola On-Line Tool).

For all other inquiries about service information, please call your Motorola Point of Contact or call:

**1-800-448-6686 in the USA**  
**1-866-522-5210 on your TTY (Text Telephone)**

## PRODUCT SAFETY

For information related to RF Exposure compliance and Batteries and Chargers Safety, please refer to “Radio Frequency (RF) Exposure Safety Standards” on page v.

## MANUAL REVISIONS

Changes may occur after this manual is printed. To obtain an updated or latest version of this manual, please go to: <http://www.motorola.com/RPX>

## ACRONYMS

The explanations in this manual are using the following acronyms:

**AC:** Alternate Current

**DC:** Direct Current

**RX:** Receiving Frequency

**TX:** Transmitting Frequency

**CX:** Connected

**DX:** Disconnected

**RF:** Radio Frequency

**P/N:** Part Number

**Table 1: RPX Repeater Series™ Models**

Label Model	Frequency Band	Output Power	Number of Channels	Battery Default Type
RPX2160	UHF	2W	16	Alkaline

# REPEATER OVERVIEW

## PARTS OF THE REPEATER

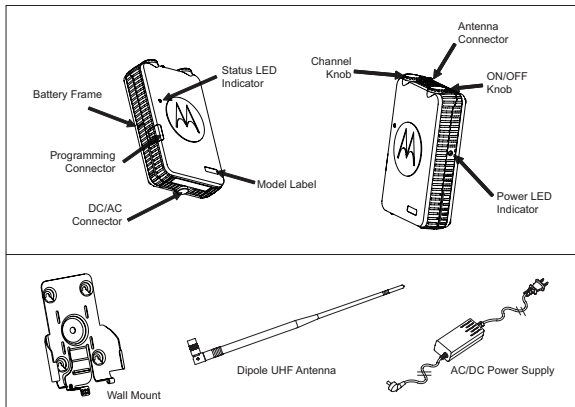

Figure 1. Repeater Parts

**Note:** The RPU2160 repeater model comes with a standard Alkaline Battery Frame. A Li-Ion Battery Frame is also available as an optional accessory (P/N HKHN4004).

## Repeater Parts Overview

The repeater is compatible with 2 - way repeater capable business radios. Please refer to "Programming Your Radios" on page 43 for more information on how to program the RDX radios to work with the repeater. For RDX radio model information details, please contact your Motorola Point of Sale.

### 1. On/Off Knob

Use to turn the repeater ON or OFF.

### 2. Channel Selector Knob

Use to switch the repeater for up to 16 different channels. Please refer to "Getting Started" on page 33 for more information.

### 3. Model Label

Indicates the model of the repeater.

### 4. Antenna

Removable UHF 450 – 470 dipole antenna. Please refer to "Repeater Installation" on page 17 for more information.

### 5. Status LED Indicator

Use to indicate, among others, repeater's power up and transmission status. Please refer to the "Getting Started" on page 33 for more information.

### 6. Power LED Indicator

The side LED indicator gives repeater AC/DC connection status whenever the repeater is working on alkaline Battery Frame (standard repeater model). Please refer to "Alkaline Batteries Frame Solution" on page 29 for more information.

### 7. AC/DC Connector

Use to connect the AC/DC power supply.

### 8. Programming Connector

Use to connect the repeater to a PC in order to program. (CPS Programming Cable (P/N RKN4155) required). Please refer to "Programming The Repeater" on page 38 for more information.



## 9. Alkaline Battery Frame

The repeater's standard package includes the Alkaline Battery frame. Refer to "Alkaline Battery Frame" on page 29 for more information.

## 10. Repeater Power Supply

The repeater is equipped with AC/DC power supply to connect the repeater to AC or DC power sources.

## Repeater Accessories

The repeater includes different types of accessories that are sold separately:

### 1. Lithium-Ion (Li-Ion) Battery Frame

Li-Ion Battery Frame (P/N HKHN4004) allows the use of high capacity RDX Li-Ion batteries in giving up to 16 hours of battery back up operation.

### 2. Antenna, Magnetic Mount and RF Cable Kit

The repeater's accessories offers an Antenna/Magnetic Mount/RF Cable Kit (P/N HKKN4022). This external antenna accessory is strongly recommended in order to allow the repeater antenna to have a better positioning and coverage. Please refer to "Repeater Installation" on page 17 for more information.

### 3. Vehicle Car Charger

For your convenience, the repeater's portfolio includes a Vehicle Charger P/N HKPN4003). Please refer to "Installations Considerations" on page 17 for more information.

### 4. Repeater Software (CPS)

The repeater offers the convenient capability of customizing your repeater features by using the CPS (Computer Programming Software). Please refer to the "Programming The Repeater" on page 38 for more information. For Software download information, contact your Motorola Distributor or Reseller.

## Repeater General Applications

The repeater is ideal as a **range extender**, that can help reach other users in areas that are normally not covered by a 2-way radio's range. It is also very useful to help resolve the common problem of the communications "**dead spots**" that are created when there are terrain obstructions (like hills or trees), concrete building structures or architectural designs that interfere with the radio signal <sup>(1)</sup>.

The repeater is designed to satisfy both MIL-SPEC 810 as well IP55 <sup>(2)</sup> level water and dust ingress <sup>(3)</sup> protection making it a rugged device can stand harsh environments. Its light weight and various back-up power options (like alkaline/Li-Ion Batteries Frames and Vehicle Charger) make this repeater a perfect portable solution for temporary <sup>(4)</sup> and on-scene applications.

The repeater operates in the UHF 450 – 470 MHz (with TX/RX 10 MHz separation) band providing 16 channels<sup>(4)</sup> with different pre-programmed settings. This particular feature allows easy and quick in field repeater deployment whenever there is need to setup more than one repeater for different users' groups.

Fully and easily programmable, the repeater gives the flexibility to customize frequencies, codes and other features according to specific needs<sup>(5)</sup>.

A key advantage for the repeater is that it has been designed to be compatible with the UHF RDX 2-way repeater capable radios. Enjoy the convenience of picking up RDX accessories (high capacity batteries and programming cables) and re-use them with your repeater. This clever interoperability feature allows you to get the most out of your complete radios and repeater system solution by offering cloning and programming among radios and repeaters.



**Figure 2a. Warehouse Application Example**

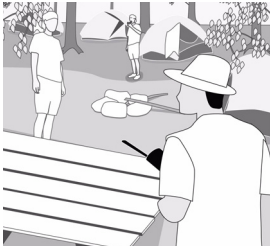

**Figure 2b. Temporary Application Example**

**Note:** (1) The repeater works best when located in an ideal place that can have good reception for re-transmitting the signal without any problems. Refer to "Pre-Installation Considerations" on page 10 for more information.

(2) The repeater is manufactured to MIL SPEC 810 C, D, E and F and G and IP55, makes it robust enough to meet stringent specifications for shock, rain, humidity and salt fog, vibration, sand/dust, temperature shock, high and low temperatures.

(3) The repeater is not a submersible device (Refer to "Appendix A: Repeater Specifications" on page 63 for more information) and it is NOT an FM (Factory Mutual) certified device.

(4) Out of the 16 pre-programmed channels that are available out of the box, you can select only ONE channel each time you TX/RX with the repeater. The repeater is NOT a multi-channel repeater.

(5) The repeater's CPS software is required. Refer to "Programming The Repeater" on page 38 for more information.

**Note:** Refer to the chapters "Pre-Installation Considerations" on page 10 and "Repeater Installation" on page 17 for proper repeater location and operation.

## How the Repeater Works

The repeater allows 2-way radios, base stations or call boxes to communicate through the repeater in order to extend the coverage range and/or overcome communication dead spots.

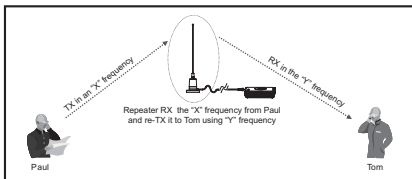

Figure 3a. How the Repeater Works (TX)

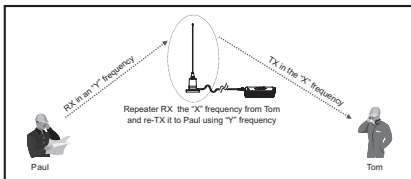

Figure 3b. How the Repeater Works (RX)

In the Figure 3a, the repeater gets the signal "X" that Paul transmits from his radio and converts it into a "Y" frequency that re-transmits to Tom. In Figure 3b, when Tom answers back to Paul, his radio also uses the "X" frequency to transmit. The repeater does the same frequency conversion ("X" to "Y") and re-transmits it to Paul using frequency "Y".

Not only are Paul and Tom able to communicate using "X" and "Y" frequencies, but so can all other 2-way, repeater capable radios that may be in the area\* working on those same frequencies settings.

**Note:** The repeater needs to re-transmit in a different frequency from what it received in order to avoid interferences.

The following are estimations of the repeater's talk coverage range:

**Table 2: Inside Building Talk Range**

Model	Industrial	Multi-Level
	Inside steel/concrete industrial buildings	Inside Multi-Level Buildings
UHF 2W	Up to 420,000 square feet	Up to 30 floors

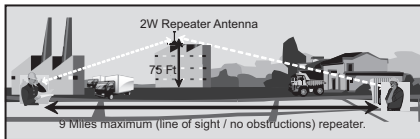

**Figure 4. Maximum Estimated Repeater Coverage Range**

**Note:** "Figure 4. Maximum Estimated Repeater Coverage Range" on page 9 shows the estimated maximum range that assume ideal antenna location, and favorable environmental and terrain conditions (no obstructions and line of sight).

As seen in Figure 4, the maximum antenna height for low power fixed stations is limited to 23 meters (75 feet) above ground. For stations operating at fixed locations for temporary periods, the antenna height is limited to 7 meters (20 feet) above ground.

**Note:** Proper programming of the repeater (Refer to "Programming The Repeater" on page 38 section for more information) and optimal repeater antenna location are the most important factors that determines the coverage and quality of your repeater communications. It is highly recommended to refer to "Pre-Installation Considerations" on page 10 before proceeding to install the repeater. Make sure your 2-way radios are repeater capable (able to manage separate TX and RX frequencies for the same channel). Refer to "Programming The Repeater" on page 38 for more information.

## PRE-INSTALLATION CONSIDERATIONS

Proper repeater installation ensures the best possible performance and reliability of the repeater. Pre-installation planning is required in order to make sure you take into account:

- RF coverage field test to decide mounting location of the repeater in relation to input power and antennas
- Site Environmental Conditions
- Electrical Requirements
- Proper programming of the repeater's parameters (in order to assure interoperability with other radio devices). "Programming The Repeater" on page 38 for more information.
- Compliant with RF exposure limits.

**Note:** You must read the entire pre-installation chapter in order to assure proper repeater operation.

## RF Coverage Field Test

The following instructions\* are quick and easy tips to test the RF coverage area and decide the best position for the Repeater Antenna (either with the antenna directly installed into the repeater device or using the antenna/magnetic mount/ RF cable accessory kit (P/N HKKN4022).

This field coverage test needs to be performed by at least two people, each one with a fully charged 2-way radio. Before the test, make sure the radios are programmed exactly on the same parameters (frequencies, codes, bandwidth, etc.) and are operating in talk around mode.

**Note:** (\*) These instructions are not intended to replace a professional RF field test.

## Choosing a Tentative Location

Prior to the RF coverage field test, you must first decide which would be the tentative locations for the repeater. You should have different options that may be evaluated according to the following aspects:

- Location should be as centered as possible to the area that is being intended for coverage so the signal strength is at the same level as possible for all points.
- If the repeater is to be located inside a building, for example, try to look for a height vertically centered location as well.
- To ensure that the location of this device and its antenna is always at a minimum distance of 20 cm away from the bystanders.
- Location should meet minimum environmental requirements. (Please refer to "Environmental Conditions at Intended Installation Site (\*)" on page 13 for more information).

- If you are planning to use the repeater to cover a large area with different buildings, it is strongly recommended that you use the antenna/magnetic mount and RF Cable Accessory Kit to install the repeater antenna in a high point that allows as much as possible line of sight (\*\*) to most of the area to be covered. Bear in mind that most of the times, increasing the repeater's antenna height improves the coverage, but is not necessarily always the case.
- If you are planning to have permanent installation for the repeater, double check that the environmental and electrical installation requirements described in the following sections are feasible.

**Note:** (\*\*) Means sight from the repeater free of obstructions at the naked eye.

## Conducting the RF Coverage Field Test

The objective of the field test is to “simulate” the transmission quality and coverage that the repeater may have based upon a chosen location. This type of testing and planning becomes very useful as it can save you extra work and money as a poor location and/or adverse environmental conditions can affect the repeater’s performance.

To do so, one person should remain in the tentative repeater location and the second person should start walking around the area intended to be covered, while transmitting with the radio.

If the quality communication between the two way radios is good, this means that the repeater transmissions should be OK.

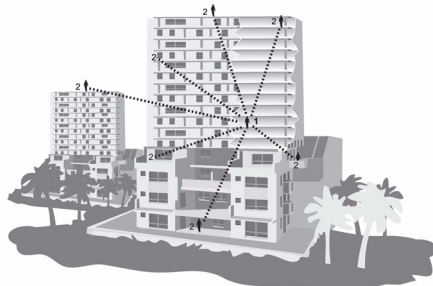

**Figure 5: Conducting the RF Coverage Field Test**

The test can be conducted by more than two people, as long as the first one remains fixed on the repeater location under evaluation.

**Note:** If you’re planning to have an external antenna installation, you should try to mimic, as much as possible, the antenna positioning to replicate the antenna’s height.



During this RF test coverage, try to test those spots that are most likely to be used for most of the people and those areas that may appear particularly challenging due to concrete/steel walls, building architecture, obstructions (like trees or vertical fire panels in ceilings or walls) and terrain shape. Make sure you walk around all those places in order to test reception and transmission signal strength.

Conduct the test transmitting preferably on those settings that you plan to have your radios and repeater programmed(\*). If possible, repeat the test using different frequencies and codes.

**Note:** (\*) Remember TX range for the repeater is 450 – 455 MHz and RX range is 465 – 470 MHz.

If the reception coverage is below expectations, try changing the height of the antenna or the repeater location (do one change at a time so you can track what is really affecting the coverage) and repeat the field test coverage.

For information on how to set up and program multiple repeaters in the same area (for different user groups), please refer to the "Setting Up Multiple Repeaters In A Single Location (Multiple User Groups)" on page 46.

## Environmental Conditions at Intended Installation Site (\*)

A key factor for repeater performance is to accurately evaluate the site environment where the repeater is being installed. Plan the installation, paying particular attention to environmental conditions at the site like temperature, humidity, dust and ventilation.

The repeater may be installed in any location suitable for electronic communications equipment provided that the environmental conditions do not exceed the equipment specifications for temperature, humidity, and air quality according to MIL 810 and IP55 ruggedness specifications (For specification details, please refer to "Appendix A: Repeater Specifications" on page 63).

## Temperature Ranges

This is the temperature measured in close proximity to the repeater. For example, if the repeater is mounted in a cabinet, the temperature that is measured is within the cabinet.

### Operating Temperature Range (Repeater Operating on Power Supply)

-30 °C (-22 °F) to +60 °C (+140 °F)

### Operating Temperature Range (Repeater Operating on Li-Ion Batteries)

-10 °C (14 °F) to +50 °C (+122 °F)

### Storage Temperature Range

-40 °C (-40 °F) to +85 °C (+185 °F)

### Humidity & Water(\*)

Do not to exceed 95% relative humidity (RH) @ (-30 °C (-22 °F) to +60 °C (+140 °F)).

**Note:** The repeater is a IP55 water resistant device, able to withstand water exposure for certain periods of time. Bear in mind that the repeater is NOT a submersible device.

## Ventilation

Also important is to make sure that there is adequate ventilation i.e. cabinets with ventilation slots (for air circulation), especially if multiple equipments are installed in the same room. In which case, a minimum distance of open space between the devices is recommended.

**Note:** (\*) Please refer to "Appendix A: Repeater Specifications" on page 63 for other product and environmental specification details.

## ELECTRICAL REQUIREMENTS

### AC/DC Power Requirements

The repeater comes equipped with a AC/DC power supply, that operates from 110 Vac to 240 Vac at 50 Hz to 60 Hz. The following are the electrical requirements:

#### RPX- AC Electrical Requirements

##### AC Input to Repeater Power Supply

Current (A)	Voltage (V)	Power (W)
0.30	120 +/- 10%	36
0.16	220 +/- 10%	36

#### RPX- DC Electrical Requirements

##### DC Input to Repeater

Current (A)	Voltage (V)	Power (W)
1.10	12 +/- 10%	24

**Note:** The AC socket must be installed near the equipment and must be easily accessible. Consideration should be given to the connection of the equipment to the supply circuit and the effect that overloading of the circuits might have on over current protection and supply wiring. Appropriate consideration of equipment ratings should be used when addressing this concern depending on where the equipment is installed. It might be a requirement to plug into a GFI protected receptable. Follow any applicable local codes.

### Site Grounding and Lightning Protection



Caution

Proper site grounding and lightning protection are vitally important consideration, Failure to provide proper lightning protection may result in permanent damage to the repeater equipment. Please refer to "Appendix B: Repeater Lightning Protection" on page 68 for basic instruction.

One of the most important considerations when designing a communications site is the ground and lightning protection system. Make sure installations meet all local and state building codes in your area.

## Electrical Ground

Ground wires carrying electrical current from circuitry or equipment at the site is included in the category of electrical ground. Examples include the AC or DC electrical power used to source equipment located at the site, and wires or cables connected to alarms or sensors located at the site.

## RF Ground

This type of ground is related to the transmission of the radio frequency energy to earth ground. An example of RF grounding is the use of shielding to prevent or at least minimize the leakage of unwanted RF transmissions from communications equipment and cables.

## Lightning Ground

Providing adequate lightning protection is critical to a safe reliable communications site. RF transmission cables, and AC and DC power lines must all be protected to prevent lightning energy from entering the site building.

Although a comprehensive coverage of the site grounding technique and lightning protection is not within the scope of this instruction manual, there are several excellent industry sources for rules and guidelines on ground and lightning protection at communications site.

**Note:** Motorola recommends the following reference source: "Motorola Quality Standards Fixed Network Equipment Installation Manual R56" P/N 6881089E50. (Refer to "Surge Protective Devices", "External Grounding" and "Internal Grounding" chapters in manual entitled "Manual Instrument R56 FXD Equipment Installation" (Manual part number 6881089E50\_)).

## REPEATER INSTALLATION

For the explanations in this chapter, please refer to the “Parts of the Repeater” on page 3 under “Repeater Overview” for more information.

### Installations Considerations

The repeater is suitable for any location where operations will meet the environmental conditions of MIL Specifications 810 and IP55 (designed to meet level of water ingress and dust protection). For details, please refer to “Appendix A: Repeater Specifications” on page 63.

### Repeater Positioning and Orientation

Once you have decided the repeater's location, make sure you place it on a flat and stable surface lying horizontal as shown in “Figure 6. Repeater Orientation on a Flat Surface” on page 17.

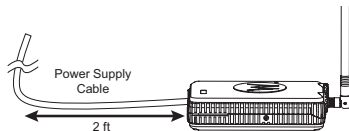

**Figure 6. Repeater Orientation on a Flat Surface**

(The actual orientation of the repeater device itself shouldn't have any impact on the repeater's performance (given a non-obstructed antenna)). When using the dipole antenna, make sure the antenna and power supply are positioned away from the repeater in a straight line (2 to 3 feet minimum) as shown in “Figure 7a. Repeater Cable Layout Using Dipole Antenna P/N HKAE4000” on page 18. For applications (like the one shown in “Figure 7b. Repeater Cable Layout Using Mag-Mount External Antenna P/N HKKN4022” on page 18) where the repeater is using an external antenna, it is very important that this antenna is positioned and secured on a stable and flat surface.

Similarly, when using an external antenna (Antenna/Magnetic Mount Kit – P/N HKKN4022), make sure that there is a minimum of 2 to 3 feet distance for both the power cable and RF cable to run straight from the repeater in order to assure that performance is not deteriorated. (refer to “Figure 7b. Repeater Cable Layout Using Mag-Mount External Antenna P/N HKKN4022” on page 18).

**Note:** Double check that the Antenna’s cable doesn’t tangle either around the repeater device or the power supply. The power supply cord also shouldn’t tangle around the repeater device or antenna.



**Figure 7a. Repeater Cable Layout Using Dipole Antenna P/N HKAE4000**

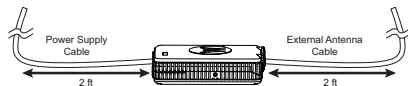

**Figure 7b. Repeater Cable Layout Using Mag-Mount External Antenna P/N HKKN4022**

When positioning the repeater, make sure the repeater antenna is placed away from obstructions, metal structures or any objects or enclosures (like elevators) that can cause any type of shielding.

## Antenna Installation Instructions

Repeater antenna installation is critical to the system performance.

Pay special attention to the instructions given in this section.

### Attaching the Dipole Antenna to the Repeater

The approved Motorola antenna for the RPU2160 is the UHF Dipole Antenna P/N HKAE4000 (50 Ohm).

(Installing the dipole antenna directly onto the repeater is recommended whenever coverage range or obstructions are not an issue or/and the repeater is likely to be moved around to other sites).

1. Align the threaded end of the antenna with the repeater's antenna connector and turn the antenna bushing clockwise to fasten it tight. "Figure 8. Attaching Dipole Antenna to the Repeater (clockwise)" on page 19

 <b>Important</b>	When screwing the antenna in to the repeater connector, make sure you tighten it completely. Otherwise, it cannot stand upright.
---	--

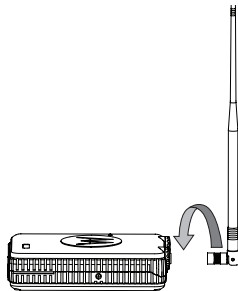
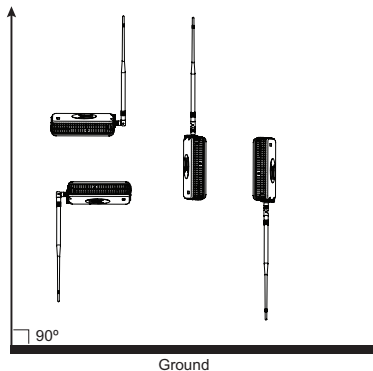
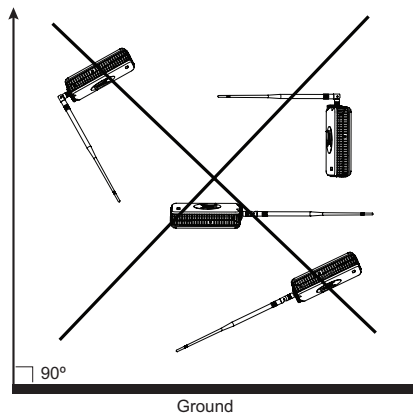

Figure 8. Attaching Dipole Antenna to the Repeater (clockwise)

2. Make sure the dipole antenna is mounted vertically (90 degrees) in reference to earth ground (either up or down). Please refer to “Figure 9. Examples of Correct Dipole Antenna Orientation” on page 20 and “Figure 10. Examples of Incorrect Dipole Antenna Orientation” on page 20 for examples of incorrect antenna positioning.



**Figure 9. Examples of Correct Dipole Antenna Orientation**



**Figure 10. Examples of Incorrect Dipole Antenna Orientation**

### Removing the Dipole Antenna from the Repeater

Turn the antenna bushing counterclockwise until you can remove it.



## Installing External Antenna Using the Antenna/Magnetic Mount/RF Cable Kit Accessory

If as an outcome of the RF Coverage Test Field, (please refer to “Pre-Installation Considerations” on page 10) you decide that you need to place an antenna away from the repeater device, you should then use the Antenna/Magnetic Mount and RF Cable accessory P/N HKKN4022.

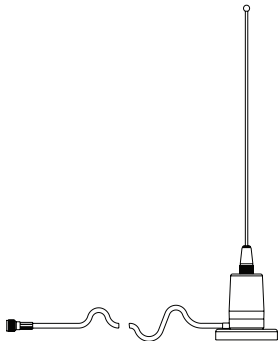

Figure 11a. Antenna Magnetic Mount and RF Cable Accessory P/N HKKN4022

**Note:** Always use Motorola approved accessories in order to assure performance and safety. Please refer to “Accessories” on page 61 for details.

## Magnetic Mount Kit Installation

- Ideally the external antenna magnetic mount should be mounted on a metal surface or other area with similar material that allows the mount magnet to stick securely.
- When installing the exterior antenna into the magnetic mount, make sure the antenna is always in a vertical orientation (either straight up or straight down, 90 ° to ground). Avoid side or skewed antenna orientations as these positions can affect repeater performance (See examples in “Figure 11b. Examples of Correct Exterior Magnetic Mount Antenna Orientation” on page 22 and “Figure 11c. Examples of Incorrect Exterior Magnetic Mount Antenna Orientation” on page 22).

- Make sure the exterior antenna magnetic mount is installed and positioned away from obstructions like metal structures, concrete walls or any other objects that may cause signal shielding.

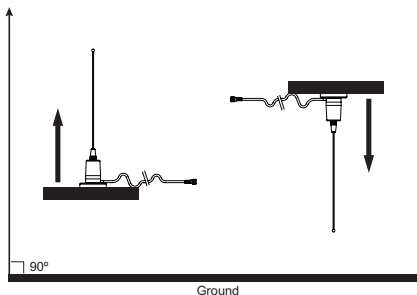

**Figure 11b. Examples of Correct Exterior Magnetic Mount Antenna Orientation**

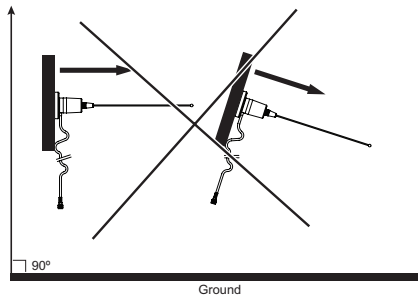

**Figure 11c. Examples of Incorrect Exterior Magnetic Mount Antenna Orientation**

## RF Cable Installation

**Note:** The RF cable is 12 feet long. Keep this in mind when locating the repeater.

In order to attach the RF Cable to the Repeater (please refer to “Figure 12. Connecting RF Cable to Repeater” on page 23), simply:

1. Align the end of the RF Cable antenna bushing with the repeater’s RF antenna connector.
2. Turn the RF Cable bushing clockwise to fasten it tightly.

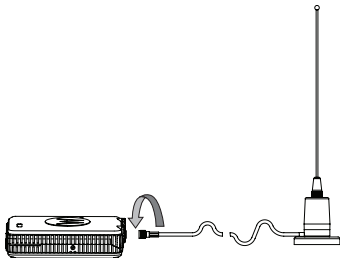

Figure 12. Connecting RF Cable to Repeater

When installing the RF cable make sure that:

- The RF Cable is taut.
- The RF Cable doesn't go around the magnetic mount antenna, antenna, the repeater device or the power supply cable as all these can cause electromagnetic interference (please refer to “Figure 11b. Examples of Correct Exterior Magnetic Mount Antenna Orientation” on page 22 and “Figure 11c. Examples of Incorrect Exterior Magnetic Mount Antenna Orientation” on page 22 for examples of wrong positioning).
- If the cable is routed through a ceiling or wall that connects outdoors, make sure there is an appropriate sealing around the cable to prevent water or other material from coming permanently into the repeater.



**Important**

Do not attempt to modify the RF cable from its original design in any way.

## Installing Exterior Antenna

In order to install the exterior antenna into the magnetic mount, simply:

1. Align the threaded end of the antenna with the magnetic mount's mini UHF connector as shown on "Figure 13. Attaching Exterior Antenna into Magnetic Mount" on page 24.
2. Turn the antenna clockwise to fasten it.

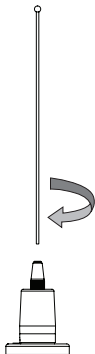

**Figure 13. Attaching Exterior Antenna into Magnetic Mount**

## Uninstalling Exterior Antenna

1. Turn counterclockwise in order to remove antenna from magnetic mount.



Caution

It is important that all antenna cables are grounded at the point they enter the building.

## Wall Mount Installation Instructions

The wall mount is recommended for permanent or semi-permanent indoors repeater installation.

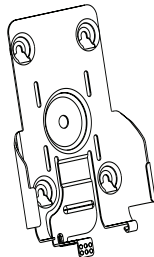

**Figure 14a. Wall Mount Holster**

The repeater comes from the factory with the wall mount attached to the repeater. Detach it by pushing out the bottom tab as shown in Figure 14b below:

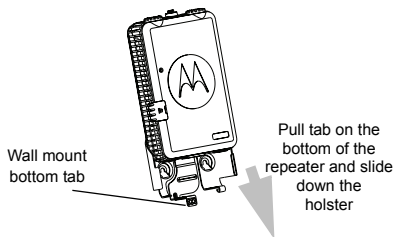

**Figure 14b. Detaching the Wall Mount from the Repeater**

To install the wall mount:

1. The wall mount holster is designed to be capable of mounting to a wall or any other similar flat surface via screws, straps or single bolt. (If you choose to use screws, make sure you secure them tightly on each one of the wall mount corners).



Remember not to install the repeater on or near conductive or shielding surfaces.

2. Once the wall mount is firmly secured to a surface, slide the repeater device from top to bottom of the holster ("Figure 14c. Installing the Wall Mount Holster" on page 26) until the repeater clicks in place into the wall mount rails.
3. Proceed to connect antenna and power supply cables.

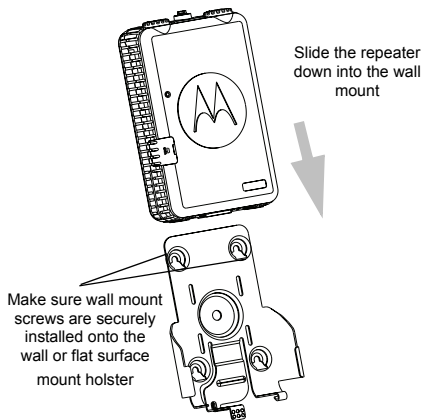

Figure 14c. Installing the Wall Mount Holster

## AC/DC Power Supply Connection

Each repeater ships standard with an AC/DC Power supply cord (P/N PMPN4002A)(9 feet long) that connects the repeater to a (110/120)/(220/240) Vac source.

**Note:** The AC/DC power supply cable is not suitable for outdoor use. Please refer to “Operational Safety Guidelines” on page vi for more details.

To connect AC/DC power supply:

1. Plug the AC/DC power supply into an AC power source of 110/220 Vac or a 12 VDC power and route it to the Repeater Jack labeled “AC/DC IN”.

**Note:** The cable from the power supply should be routed in a straight line and should not tangle, go around or wrap around the repeater device, the antenna or the RF Cable. See “Figure 7a. Repeater Cable Layout Using Dipole Antenna P/N HKAE4000” on page 18 (Notice in this picture that the cable must be laid down straight for at least 2 feet).

## Vehicle Charger

The repeater offers the convenience of a Vehicle Charger accessory (P/N HKPN4003, sold separately).



Figure 15a. Vehicle Charger

## Repeater Installation – Example

- The following repeater installation example in “Figure 15b. Repeater Installation Example” on page 28, shows the magnetic mount and RF cable installed on top of the car’s roof in order to secure the exterior antenna against wind and allow repeater to be placed inside the car. This is a convenient configuration as the repeater can be protected against harsh weather. It can also be re-charged directly from the car battery \* using Vehicle Charger P/N HKPN4003, without interrupting or reducing the repeater power output.

**Note:** This configuration example assumes that the repeater is working on back-up batteries. (The power supply is not designed for outdoor use).



Figure 15b. Repeater Installation Example



## ALKALINE BATTERY FRAME

### ABOUT ALKALINE BATTERIES

Please visit your Alkaline batteries' manufacturer website for information and guidelines regarding handling and disposal of Alkaline batteries.

 <b>Important</b>	Do not store alkaline batteries in a non-operating equipment for longer than 30 days.
---	---

### Alkaline Batteries Frame Solution

The repeater's standard package comes equipped with an Alkaline Battery Frame Solution, ("Figure 16a. Alkaline Battery Frame" on page 29 – alkaline batteries are not included). The repeater requires 12 AA batteries.

In the event of an AC/DC power failure or absence, if the repeater is using back-up alkaline batteries, the repeater will automatically switch to back-up mode to the alkaline batteries.

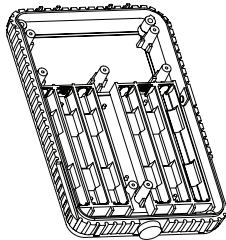

Figure 16a. Alkaline Battery Frame

### Alkaline Battery Life Estimation

When the repeater is working on back-up alkaline batteries, the estimated battery life time (assumed fully charged) is 16 hours.

## Alkaline Battery and Power Detection LED (Side)





Do not attempt to recharge alkaline batteries. They are non-rechargeable.

The Alkaline Battery Power LED on the side of the repeater gives you status on the external power connection and indication on whether or not the batteries are being detected (as long the repeater is getting AC/DC power).

In the case that the repeater loses the external AC/DC power, this LED goes OFF. In this case, refer to the FRONT LED status (Table 4), which gives other battery status information.

**Table 3: Repeater – Alkaline Frame Battery and Power Detection LED (Side)**

LED Status	Batteries Detection	AC/DC Status	Comments
 Red (Fast) Blinking	No Batteries Detected	AC/DC Connected	When the battery frame is empty or the batteries are dead and AC/DC power is connected.
 Steady Red	Batteries Detected	AC/DC Connected	Batteries are good and in place and AC/DC is connected.
 OFF	See FRONT LED	AC/DC Disconnected	When AC/DC is disconnected. In this case, check the FRONT LED for battery status.

**Note:** Alkaline Battery Frame is also available as a stand-alone accessory (P/N HKHN4003).

## Installing/Removing the Alkaline Battery Frame

1. Ensure that the wall mount holster is detached from the repeater. Refer to instructions in the “Wall Mount Installation Instructions” on page 24.
2. Turn OFF the repeater if it is turned ON.
3. Disconnect AC/DC Power.
4. Use a Phillips screwdriver to remove the four corner screws located at each corner on the back of the repeater, disconnect power harness and lift away the repeater back battery frame. “Figure 16b: Installing the Alkaline Battery Frame into/from the Repeater” on page 31.

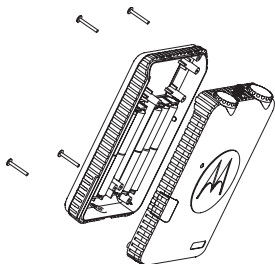
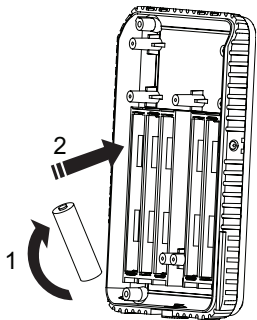

Figure 16b: Installing the Alkaline Battery Frame into/from the Repeater

5. Arrange alkaline batteries to match each of the alkaline frame batteries' polarity (+ or -) markings and slide them into each one of the alkaline battery frame compartments. Repeat until 12 batteries have been properly placed. Plug in the power harness. "Figure 16c: Installing the Alkaline Batteries" on page 32.



**Figure 16c: Installing the Alkaline Batteries**

6. The repeater battery frame has an internal cable. Make sure this internal cable is connected between the repeater and the battery frame.

7. Assemble the alkaline battery frame (loaded with the alkaline batteries) into the back of the repeater by tightening securely the four screws on each of the four corners on the back of the repeater. Please refer to "Figure 16b: Installing the Alkaline Battery Frame into/from the Repeater" on page 31.



**Important**

When securing back the alkaline frame lid into the repeater, it is very important to make sure the screws are tightened firmly to preserve the sealing of your repeater. Failing to do so can negatively impact the repeater's IP55 water and dust resistant feature.

### **LI-ION BATTERY FRAME (OPTIONAL ACCESSORY)**

The repeater is capable of operating with Li-Ion batteries. The Li-Ion Battery Frame, P/N HKHN4004 is sold separately as an accessory. Operation details are included in the instructions leaflet that ships with this accessory.

# GETTING STARTED

## TURNING REPEATER ON/OFF

 <b>Caution</b>	<p>Never transmit without having a transmit antenna connected to the TX antenna jack of the repeater.</p>
---	---

1. Turn the ON/OFF knob clockwise to turn on the repeater. The repeater front LED blinks a red light and then, becomes solid red.

## REPEATER STATUS LED (FRONT LED)

Table 4 "Repeater Front LED (Status Indicator)" on page 33 shows the repeater LED status summary:

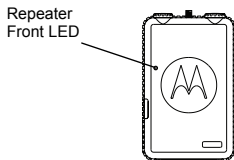

Figure 17. Repeater Front LED Location

## Radio LED Indicators

Table 4: Repeater Front LED (Status Indicator)











MODE	LED STATUS	
Transmitting/ Receiving		Solid Red
Receiving Only (*)		Solid Green
Idle		Red (Slow) Blinking
Power Up		Solid Red 2 – 3 seconds
Transmitting in Low Power		Solid Orange

Table 4: Repeater Front LED (Status Indicator) (Continued)

MODE	LED STATUS	
Low Battery Shutdown		Orange (Fast) Blinking
Low Battery		Orange Blinking
Fatal Error at Power Up		1 Green Blink, 1 Orange Blink, 1 Green Blink, then repeat
Unprogrammed Channel		Double Red (Slow) Blinking
Non-Repeater Channel Mode		1 Red Blink, 1 Green Blink, then repeat
<b>Note:</b>	(*) This is an abnormal status, as the repeater is only receiving. Double check your settings to ensure the repeater is working properly.	

## SELECTING A CHANNEL

The repeater offers 16 different channels from which you can choose ONE channel at a time for the repeater to operate. To select a channel, rotate the Channel Selector Knob until you reach the desired channel. Each channel has its own

pre-programmed Frequency, Interference Eliminator Code and Bandwidth Settings. Please refer to the following table for factory default values details:

**Table 5: Repeater Channels Default Settings**

Channel #	Transmit Band 450 – 455 MHz		Common Parameters			Receive Band 465 – 470 MHz	
	Frequency (TX) Index #	Frequency (TX) MHz	Code (Index #)	Code Value (Hz)	Bandwidth	Frequency (RX) Index #	Frequency (RX) MHz
1	65	451.1875	1	67	12.5 kHz	34	466.0375
2	66	451.2375	4	77	12.5 kHz	35	466.0625
3	67	451.2875	8	88.5	12.5 kHz	36	466.0875
4	68	451.3375	29	179.9	12.5 kHz	37	466.1125
5	69	451.4375	0	none	12.5 kHz	38	466.1375
6	70	451.5375	1	67	12.5 kHz	39	466.1625
7	71	451.6375	6	82.5	12.5 kHz	40	466.1875
8	72	452.3125	10	94.8	12.5 kHz	41	466.2125

**Table 5: Repeater Channels Default Settings (Continued)**

Channel #	Transmit Band 450 – 455 MHz		Common Parameters			Receive Band 465 – 470 MHz	
	Frequency (TX) Index #	Frequency (TX) MHz	Code (Index #)	Code Value (Hz)	Bandwidth	Frequency (RX) Index #	Frequency (RX) MHz
9	74	452.4125	29	179.9	12.5 kHz	42	466.2375
10	75	452.5125	0	0	12.5 kHz	50	467.8625
11	76	452.7625	3	74.4	12.5 kHz	51	467.8875
12	77	452.8625	5	79.7	12.5 kHz	52	467.9125
13	65	451.1875	7	85.4	12.5 kHz	53	469.4875
14	66	451.2375	9	91.5	12.5 kHz	54	469.5125
15	72	452.3125	11	97.4	12.5 kHz	55	469.5375
16	74	452.4125	13	103.5	12.5 kHz	56	469.5625

In order to modify these default values, you should use the CPS Software. Please refer to "Programming The Repeater" on page 38 for more details.



## REPEATER PROGRAMMING DEFAULT VALUES

"Programmable Features Default Values" on page 37 shows the default factory values that the repeater has pre-programmed. These values can only be customized by using the CPS software.

**Table 6: Programmable Features Default Values**

Feature	Values	Default
TX Timeout	1, 2 or 3 minutes	1 minute
TX Hangtime (or Carrier Delay)	Off to 50 seconds	3 seconds
Courtesy Beep	ON or OFF	OFF
Repeater ID	15 minutes, 30 minutes, after TX hangtime, or OFF	15 minutes
On Battery Back-Up	OFF, 15 minutes, 30 minutes, 45 minutes, 60 minutes	30 minutes
Low Battery TX	0 to 255 minutes	10 minutes
Number of Channels	1 to 16	16
Reverse Burst	180 to 240	180
TX Power	2W	2W
TX BW	12.5 or 25.0 kHz	12.5 kHz
RX BW	12.5 or 25.0 kHz	12.5 kHz

# PROGRAMMING THE REPEATER

## PROGRAMMING FEATURES OVERVIEW

The repeater is a fully programmable device that provide features customization by using the CPS (Computer Programming Software).

The CPS allows to program frequencies and Codes (either from a pre-loaded frequency default list table or allowing to enter directly any customized value) as well as other features such as Bandwidth, Hang Time-out, Repeater ID Timer, Courtesy Beep timer, Transmit Time Out Timer, Reverse Burst, among others.

One of the key advantages of the CPS is the flexibility to quickly and easily program and clone several repeaters using a customized profile. The CPS also provides security by giving the option to set up a codeplug password for profile repeater's management (CPS Manager Lock).

Please refer to the CPS software HELP File (under “Content and Index”) where you can find the details and explanations for each one of the repeater's programmable features.

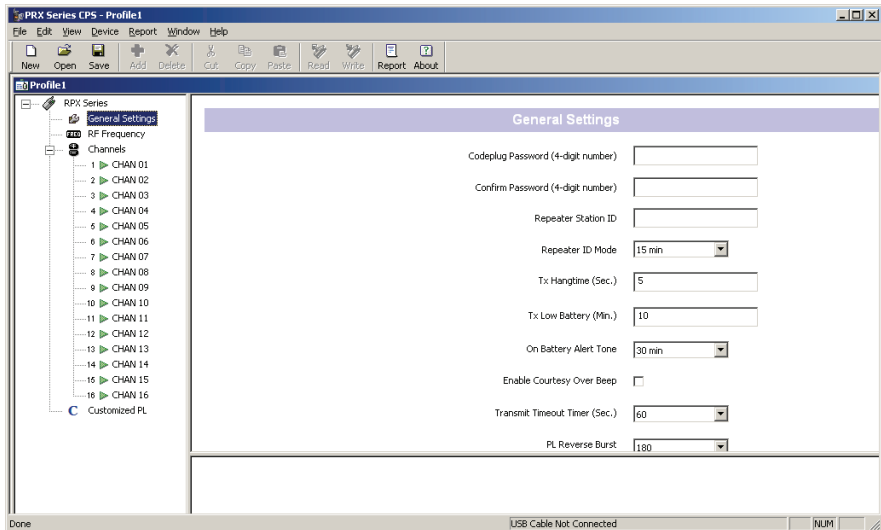

**Figure 18. Example of the CPS Repeater Interface**

**Note:** Contact your Motorola distributor or reseller in order to get information on how to get a copy of the CPS software.

## Programming the Repeater Using the CPS

Before you begin programming the repeater make sure you have available:

- A PC ( Windows® XP, Windows 2000 compatible, Vista)
- CPS Programming Cable (sold separately as an accessory P/N RKN4155),
- CPS\* Software installed
- Repeater batteries are charged or repeater is connected to a AC/DC power line.

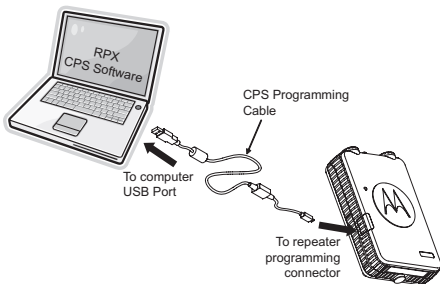

**Figure 19. Programming the Repeater Using the CPS**



### Important

Please notice that this CPS Programming cable's mini-connector should not be used for connecting devices other than the RDX Series chargers (RLN6304/RLN6375) and RPX repeaters.

## How to Read and Modify Your Repeater's Features

1. Ensure you have installed the latest CPS in your computer.
2. Turn the repeater OFF.
3. Plug the CPS Programming Cable P/N RKN4155 into the Repeater's programming connector. "Figure 19. Programming the Repeater Using the CPS" on page 40.
4. Connect the other end of the CPS cable into your computer 's USB port.
5. Open your CPS software and turn your repeater ON.
6. Click "read" icon in the upper bar menu.

**Note:** The "read" icon is grayed-out until the computer detects the CPS Programming Cable.

7. When the CPS reads the repeater successfully, you can see a window pop up showing a bar progress icon indicating the repeater's profile is being read.

**Note:** You can now read and modify all your repeater features with the options available in the left side menu in your profile window. For more details on how to read, write or modify radio features, please refer to the **CPS Help Menu → Content and Index**. Detailed information about how to clone the repeater's profile is also available in the **CPS Help Menu → Content and Index → Cloning Repeaters**.

## CPS Connection Troubleshooting

Table 7: Programming Mode: Troubleshooting

Symptom	Try This
CPS doesn't read the repeater or write to the repeater	Make sure the CPS cable is securely connected on both ends (programming port in the repeater and USB port in the computer). Make sure your repeater hasn't run out completely of battery power or it is connected to an AC/DC supply. Make sure the CPS cable is not damaged.
CPS displays "Error: Communication Error" when trying to read or write to the repeater	Make sure your repeater is ON/Double check that the repeater model matches your CPS version and region as they should be compatible in order to read and write. For checking your CPS version, click in the "about" icon in the upper tool bar.
CPS displays "your repeater doesn't match your region"	Double check that the radio model matches your CPS version and region as they should be compatible in order to read or write. For checking your CPS version, click on the "about" icon in the upper tool bar.
When trying to clone the repeater, the CPS displays an error or the cloning fails	Please refer to "Cloning Repeaters" in the CPS Help File for details on cloning details.

# PROGRAMMING YOUR RADIOS

## PROGRAMMING YOUR RDX RADIOS TO WORK WITH THE REPEATER

The RDX Series Radio is fully compatible with your repeater as it is of the same UHF band and it supports repeater capability features(\*). However, in order to configure the radio to communicate with the repeater, there are basic tips that you should take into account:

**Note:** (\*) For RDX repeater capable models, please refer to 2-Way RDX Repeater Capable UHF Radios on page 62.

For more information, please contact your Motorola Point of Purchase or call:  
1-800-448- 6686 in the USA  
**1-866-522-5210 on your TTY (Text Telephone)**

- Make sure the channels in both the RDX radio and the repeater that you want to use with the repeater capability are actually enabled in the CPS with a “check” box looking as follows:

The screenshot displays the configuration window for 'CHAN 04 (4)'. On the left, a sidebar lists channels from CHAN 01 to CHAN 14, with 'CHAN 04' selected. The main area is divided into 'Receive' and 'Transmit' sections. The 'Receive' section includes fields for Frequency (MHz) set to '4 - 451.337500', Bandwidth (KHz) set to '12.5', and PL/DPL Code set to '29 - 179.9 Hz'. The 'Transmit' section includes fields for Frequency (MHz) set to '20 - 466.112500', Bandwidth (KHz) set to '12.5', Repeater Power set to 'High', and PL/DPL Code set to '29 - 179.9 Hz'. At the bottom right, the 'Repeater' checkbox is checked, and a blue arrow points to it.

**Figure 20. Enabling Repeater capability settings**



- Make sure the TX frequency and PL Code in the radio channel that has been chosen for repeater, is the same as the RX frequency in the repeater. Same for the RX frequency in your RDX radio: make sure it matches the TX frequency and PL code in the repeater's channel.
- The repeater has 16 channels available, each one with two TX/RX frequency pairs. You can either use the repeater default programmed frequencies and customize the RDX channels to match the repeater's or you can customize the repeater frequencies to different frequencies pairs to match frequency in the RDX radios.

**Note:** Take into account that when matching channel frequencies between the repeater and the radios, you must also need to make sure all other channel parameters (i.e. codes, bandwidth and reverse burst) are at the same correspondent values in order for the radios-repeater communications to take place properly.

## PROGRAMMING MULTIPLE REPEATERS

### SETTING UP MULTIPLE REPEATERS IN A SINGLE LOCATION (MULTIPLE USER GROUPS)

As the repeater has 16 different programmable channels to choose from for setting up the TX/RX frequency pairs, it is possible to configure multiple repeaters in the same location or around the same area.

Whenever you need to expand the 2-way radios' coverage in the same area but for different user's groups, you can use multiple repeaters (in different channels) located at the same site. To ensure that the different groups do not interfere with each other and that each group has their private communications, each repeater and the radios set must have different channel settings (please refer to "Antenna Installation Instructions" on page 19 and "Programming The Repeater" on page 38 for more information).

Additionally, in order to minimize the interferences in the multi-repeater system (due to inter-modulation) you can follow these optional configuration recommendations:

1. The repeaters should be physically separated at least 5 feet apart from each other.
2. Ensure that the frequencies chosen do not have any interference with other user's frequencies or signals in the area. (You can do this by following up with a FCC Coordinator and/or by using an RF Analyzer Spectrum device).

- When choosing frequencies in either the TX or RX band, take into account to have a minimum separation of 100 kHz between frequencies in the same band (See Figure 21). For example,  $F1_{tx} = 451$  MHz,  $F2_{tx} = 452$  MHz,  $F3_{tx} = 453.2$  MHz and  $F1_{rx} = 466.3$  MHz,  $F2_{rx} = 466.9$  MHz,  $F3_{rx} = 468.2$  MHz.
- When configuring three or more repeaters (with different channels), it is recommended to have an asymmetrical separation between the frequencies in the same band. (See "Figure 21: Setting Up Multiple Repeaters)" on page 47 below For the same example given in the previous paragraph,  $A1 \neq A2$  and  $B1 \neq B2$ .
- Make sure to choose different PL codes in each channel.

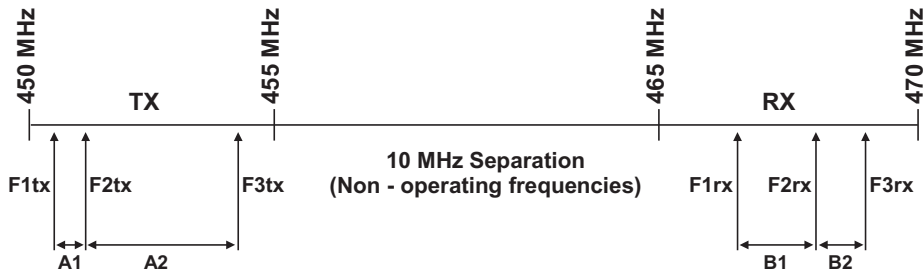

Figure 21: Setting Up Multiple Repeaters)

**Note:** For other requirements (environmental, electrical and mechanical), make sure you read sections ahead, especially information related to equipment ventilation.

# REPEATER CLONING

## RDX RADIO TO REPEATER CLONING

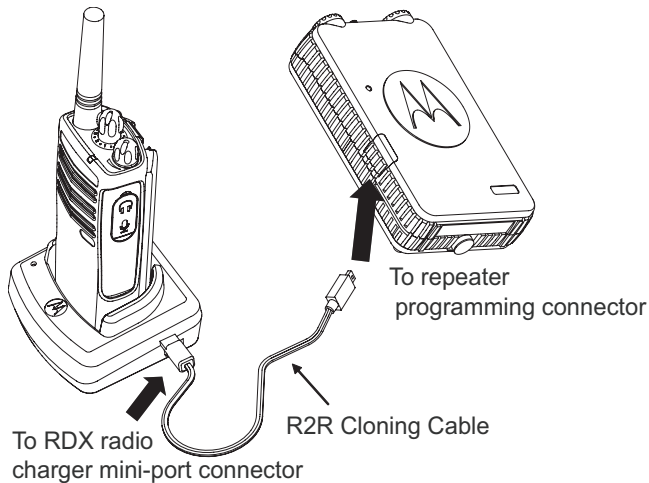

Figure 22. Cloning from an RDX radio into the Repeater

## OPERATING INSTRUCTIONS

Below are instructions on how to clone from your RDX radio into the repeater.

**Note:** It is NOT possible to clone from the repeater into the RDX radio.

The only parameters that can be cloned into the repeater are:

- channel frequency,
- code,
- bandwidth,
- power,
- reverse burst,
- scan list
- the number of channels.

Before you start the cloning process, make sure you have the following components:

- Fully charged batteries on both the RDX radio and the repeater
- One Single Unit Chargers (SUC) for the RDX Radio (either P/N RLN6304 or RLN6175)
- An RDX Radio to Radio (R2R) Cloning Cable P/N RLN6303
- An RDX Radio, repeater capable

## CLONING INSTRUCTIONS

1. Turn OFF both the radio and the repeater.
2. Unplug any cables (power supply or USB cables) from the Single Unit Charger.
3. Plug one side of the cloning cable mini connector to the Single Unit Charger. Plug the other end to the Repeater programming port connector.

**Note:** During the cloning process, no power is being applied to the Single Unit Charger. The batteries are not charged. A data communication is being established between the repeater and the radio.

4. Turn ON the repeater.
5. Power up the RDX radio following the sequence below:
  - Long press the PTT button and SB2 simultaneously while turning the radio ON.
  - Wait for 3 seconds before releasing the buttons until a distinctive audible tone is heard. Press and release Side Button 1 (SB1) on the radio to start the cloning.

**Note:** After cloning is completed, the RDX radio sounds either a “pass” tone (cloning was successful) or a “fail” tone (cloning process has failed). The “pass” tone sounds like a good key “chirp” whereas the “fail” tone sounds similar to a “bonk” tone. If the RDX radio is a display model, it either shows “Pass” or “Fail” on the display (a tone is heard within 5 seconds).

6. Once you have completed the cloning process, turn the RDX radio OFF and ON to exit ‘clone’ mode.
7. Turn the repeater OFF and ON to exit “clone” mode.

**Important**

- If the RDX channels contains frequencies that are not within the repeater TX or RX frequency range: the repeater does not work on these channels.
- In the RDX radio, make sure that in each one of the TX/ RX frequency pairs, the bandwidth setting has exactly the same value. For example, if in Channel 7 the TX bandwidth separation is 12.5 kHz, then the corresponding RX bandwidth separation in this same channel 7 should be also 12.5 kHz.

## WHAT TO DO IF CLONING FAILS

The radio emits an audible “bonk” indicating that the cloning process has failed. In the event that cloning fails, try performing each of the following tests before trying to start the cloning process again:

1. Ensure that the batteries on both radio and repeater are fully charged.
2. Check the cloning cable connection on both ends.
3. Ensure that the battery is engaged properly on to the RDX radio.
4. Ensure that the RDX radio is in cloning mode.
5. Ensure that the repeater is turned ON.

## TROUBLESHOOTING

Symptom	Try This...
<b>No Power</b>	If working with Li-Ion frame, recharge or replace the Li-Ion battery. If working with alkaline battery frame, replace AA batteries. Reposition or replace AA batteries. Extreme operating temperatures may affect battery life. Verify repeater is connected to AC/DC.
<b>Limited Talk Range</b>	Steel and/or concrete structures, heavy foliage, buildings or vehicles decrease range. Check for clear line of sight to improve transmission. Verify the repeater and the radio are correctly programmed.
<b>Transmissions Are Noisy and Not Clear</b>	Make sure channel settings are compatible. Whenever using the repeater to work with radios different from Motorola RDX series, it is recommended to use 25 kHz bandwidth settings. The Motorola RDX and RPX Series radios use companding at 12.5 kHz to enhance audio quality. Other radios may not have this feature and may not be compatible at 12.5 kHz bandwidth.



Symptom	Try This... (Continued)
<b>Messages Are Not Received</b>	Confirm that the radios have the same Channel, Frequency, Interference Eliminator Code and Scramble Code settings and are consistent with the Repeater's settings. Verify the range coverage is appropriate and there are no obstacles or shielding.
<b>Heavy Static or Interference</b>	Radios are too close to repeater; they must be at least five feet apart. Radios are too far apart from the repeater's antenna. Double check to make sure there are no obstacles interfering with transmission. Reposition the repeater antenna.
<b>Low Batteries – Front LED is showing Battery Alert</b>	If you are working with a Li-Ion frame accessory, replace Li-Ion batteries. If you're working with an alkaline frame, replace AA batteries. Extreme operating temperatures affect battery life.
<b>Li-On Side Power LED Light Does Not Come On</b>	(This case applies only if using Li-Ion Battery Frame Accessory). Check if repeater's Li-Ion batteries are properly inserted and/or check battery/charger contacts to be sure they are clean and charging pin is inserted correctly.

Symptom	Try This... (Continued)
<b>Front Battery is showing Low Battery Alert Although New Batteries Are Installed</b>	If using Li-Ion Battery Frame accessory, verify that the repeater is set to the correct battery types (refer to “Accessories” on page 61 for battery part number information) and is well positioned into the battery frame according to instructions. If using Alkaline Battery frame, make sure batteries are properly inserted and are new.
<b>Repeater Can't Receive or Can't Re-transmit/Radio Can Transmit But Can't Receive</b>	Check repeater's programming settings versus radio's settings.
<b>Battery Does Not Charge Although It Has Been Placed in the Li-On Battery Frame For a While</b>	If using Li-Ion Battery Frame accessory, check if the repeater is connected to the AC/DC power and is getting appropriate power. Check the SIDE LED indicators. Charge the Li-ON batteries using an external charger to see if the batteries are damaged. Make sure the operating temperatures are within specific ranges.

**Note:** The RPX Repeater Series™ are designed with a companding feature that is compatible with Motorola 2-way Business Radios. If you're working with a different radio and you experience static or noise in your communications, double check that the radios are capable of companding.

## USE AND CARE



Use a soft damp cloth  
to clean the exterior

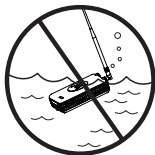

Do not immerse  
in water



Do not use alcohol or  
cleaning solutions

### If the repeater is submerged in water...



Turn repeater OFF  
and remove batteries  
and antenna

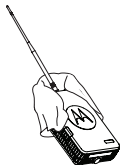

Dry with soft cloth



Do not use repeater  
until completely dry

# MOTOROLA LIMITED WARRANTY FOR THE UNITED STATES

## What Does this Warranty Cover?

Subject to the exclusions contained below, Motorola, Inc. warrants its telephones, pagers, and consumer and business two-way radios (excluding commercial, government or industrial radios) that operate via Family Radio Service or General Mobile Radio Service, Motorola-branded or certified accessories sold for use with these Products (“Accessories”) and Motorola software contained on CD-ROMs or other tangible media and sold for use with these Products (“Software”) to be free from defects in materials and workmanship under normal consumer usage for the period(s) outlined below.

This limited warranty is a consumer's exclusive remedy, and applies as follows to new Motorola Products, Accessories and Software purchased by consumers in the United States, which are accompanied by this written warranty.

## Products and Accessories

Products Covered	Length of Coverage
<b>Products and Accessories</b> as defined above, unless otherwise provided for below.	<b>One (1) year</b> from the date of purchase by the first consumer purchaser of the product unless otherwise provided for below.
<b>Decorative Accessories and Cases.</b> Decorative covers, bezels, PhoneWrap™ covers and cases.	<b>Limited lifetime warranty</b> for the lifetime of ownership by the first consumer purchaser of the product.
<b>Business Two-way Radio Accessories</b>	<b>One (1) year</b> from the date of purchase by the first consumer purchaser of the product.
<b>Products and Accessories that are Repaired or Replaced.</b>	<b>The balance of the original warranty or for ninety (90) days</b> from the date returned to the consumer, whichever is longer.

## Exclusions

**Normal Wear and Tear.** Periodic maintenance, repair and replacement of parts due to normal wear and tear are excluded from coverage.

**Batteries.** Only batteries whose fully charged capacity falls below 80% of their rated capacity and batteries that leak are covered by this limited warranty.

**Abuse & Misuse.** Defects or damage that result from: (a) improper operation, storage, misuse or abuse, accident or neglect, such as physical damage (cracks, scratches, etc.) to the surface of the product resulting from misuse; (b) contact with liquid, water, rain, extreme humidity or heavy perspiration, sand, dirt or the like, extreme heat, or food; (c) use of the Products or Accessories for commercial purposes or subjecting the Product or Accessory to abnormal usage or conditions; or (d) other acts which are not the fault of Motorola, are excluded from coverage.

## Use of Non-Motorola Products and Accessories.

Defects or damage that result from the use of Non-Motorola branded or certified Products, Accessories, Software or other peripheral equipment are excluded from coverage.

**Unauthorized Service or Modification.** Defects or damages resulting from service, testing, adjustment, installation, maintenance, alteration, or modification in any way by someone other than Motorola, or its authorized service centers, are excluded from coverage.

**Altered Products.** Products or Accessories with (a) serial numbers or date tags that have been removed, altered or obliterated; (b) broken seals or that show evidence of tampering; (c) mismatched board serial numbers; or (d) nonconforming or non-Motorola housings, or parts, are excluded from coverage.

**Communication Services.** Defects, damages, or the failure of Products, Accessories or Software due to any communication service or signal you may subscribe to or use with the Products Accessories or Software is excluded from coverage.

## Software

Products Covered	Length of Coverage
<b>Software.</b> Applies only to physical defects in the media that embodies the copy of the software (e.g. CD-ROM, or floppy disk).	<b>Ninety (90) days</b> from the date of purchase.

## Exclusions

**Software Embodied in Physical Media.** No warranty is made that the software will meet your requirements or will work in combination with any hardware or software applications provided by third parties, that the operation of the software products will be uninterrupted or error free, or that all defects in the software products will be corrected.

## Software NOT Embodied in Physical Media.

Software that is not embodied in physical media (e.g. software that is downloaded from the internet), is provided “as is” and without warranty.

## WHO IS COVERED?

This warranty extends only to the first consumer purchaser, and is not transferable.

## WHAT WE WILL DO TO CORRECT WARRANTY PROBLEMS

At no charge to you, we have the option to repair or replace the Products or software that do not conform to the warranty, or to refund the Products’ purchase price. We may use functionally equivalent reconditioned/refurbished/pre-owned or new Products or parts. No software updates are provided.

## HOW TO OBTAIN WARRANTY SERVICE OR OTHER INFORMATION?

Contact your Motorola point of purchase.

Please call:

1-800-448- 6686 in the USA

1-866-522-5210 on your TTY (Text Telephone)

You will receive instructions on how to ship the Products to Motorola. You must ship the Products to us with freight, duties and insurance prepaid.

Along with the Products you must include:

- (a) a copy of your receipt, bill of sale or other comparable proof of purchase;
- (b) a written description of the problem;
- (c) the name of your service provider (if this Product requires subscription service);
- (d) the name and location of the installation facility (if applicable) and, most importantly;
- (e) your address and telephone number. If requested, you must also return all detachable parts such as antennas, batteries and chargers.

#### RETAIN YOUR ORIGINAL PROOF OF PURCHASE.

We will ship repaired or replacement Products at our expense for the freight and insurance, but at your expense for any duties. If additional information is needed, please contact us at the telephone number listed above.

#### SOFTWARE COPYRIGHT NOTICE

The Motorola products described in this manual may include copyrighted Motorola and third party software stored in semiconductor memories or other media. Laws in the United States and other countries preserve for Motorola and third party software providers certain exclusive rights for copyrighted software, such as the exclusive rights to distribute or reproduce the copyrighted software. Accordingly, any copyrighted software contained in the Motorola products may not be modified, reverse-engineered, distributed, or reproduced in any manner to the extent allowed by law.

Furthermore, the purchase of the Motorola products shall not be deemed to grant either directly or by implication, estoppel, or otherwise, any license under the copyrights, patents, or patent applications of Motorola or any third party software provider, except for the normal, non-exclusive, royalty-free license to use that arises by operation of law in the sale of a product.

## PATENT NOTICE

This product is covered by one or more of the following United States patents.

5896277 5894292 5864752 5699006 5742484  
D408396 D399821 D387758 D389158 5894592  
5893027 5789098 5734975 5861850 D395882  
D383745 D389827 D389139 5929825 5926514  
5953640 6071640 D413022 D416252 D416893  
D433001

## EXPORT LAW ASSURANCES

This product is controlled under the export regulations of the United States of America. The Governments of the United States of America may restrict the exportation or re-exportation of this product to certain destinations. For further information contact the U.S. Department of Commerce.



## ACCESSORIES

### RPX REPEATER SERIES ACCESSORIES

#### ANTENNA ACCESSORIES

Part No.	Description
HKKN4022	Antenna with MAG Mount & 12 foot RF Cable Kit
HKAE4000	Dipole Antenna 450 – 470 MHz Kit

#### BATTERIES ACCESSORIES

Part No.	Description
HKHN4003	RPX Repeater Series™ Alkaline Battery Frame
HKHN4004	RPX Repeater Series™ Li-On Battery Frame

#### POWER SUPPLIES ACCESSORIES

Part No.	Description
HKPN4003	Vehicle Charger
PMPN4002	AC/DC Repeater Power Supply

#### BATTERY ACCESSORIES (\*)

Part No.	Description
RLN6305	High Capacity Li-Ion Battery 2200 mAh
RLN6308	Ultra High Capacity Li-Ion Battery 2400 mAh
<b>Note:</b>	(*) These are the orderable part numbers. Authorized batteries under these kits are: <b>RLN6305:</b> 60012001001 or 6080384X63 <b>RLN6308:</b> 60012000001 or 6080384Y10

## RDX PICK-UP RADIOS AND ACCESSORIES

### CABLES ACCESSORIES

Part No.	Description
RLN6303	Radio to Radio Cloning Cable
RKN4155	CPS USB Programming Cable

### CHARGER ACCESSORIES

Part No.	Description
RLN6304	Rapid Charger Kit
RLN6309	Multi-Unit Charger (MUC) Kit
RLN6175	Standard Drop-in Tray Charger

**Note:** For charging RDX radios and stand-alone Li-Ion batteries only.

### 2-WAY RDX REPEATER CAPABLE UHF RADIOS

Part No.	Description
RDU4160	RDX UHF 4W 16 Channel 2-Way Radio
RDU4100	RDX UHF 4W 10 Channel 2-Way Radio

## APPENDIX A: REPEATER SPECIFICATIONS

Product Specifications	UHF 25 kHz	UHF 12.5 kHz
Power Output	2W	2W
FCC ID	AZ492FT4887	AZ492FT4887
Emission Designators	16K0F3E	11K0F3E
Operating RF Band (MHz)	450 – 470	450 – 470
Frequency Separation	10 MHz (Programmable)	10 MHz (Programmable)
TX Frequency Band	450 – 455 MHz	450 – 455 MHz
RX Frequency Band	465 – 470 MHz	465 – 470 MHz
Channel Spacing (narrow and wide band)	25 kHz	12.5 kHz
Mode of Operation	Duplex	Duplex
Code Signalling	Morse Code	Morse Code
Number of Operating Channels	1 (TX/RX) Channel	1 (TX/RX) Channel
Number of Software Programmable Channels/ Knob Channels	16	16
Synthesized Steps	1 Hz	1 Hz
Tone/Code Signalling	PL/DPL	PL/DPL
Hang-Time Timer	0 – 50 seconds (Programmable)	0 – 50 seconds (Programmable)

Product Specifications	UHF 25 kHz	UHF 12.5 kHz
Time-Out Timer	1, 2 or 3 minutes	1, 2 or 3 minutes
RF Connector	MIni UHF	MIni UHF
Cigarette Lighter Connector (Vehicle Adaptor)	Yes	Yes
Antenna Impedance	50 Ohms	50 Ohms
Duty Cycle	100%	100%
PL Codes	39+ Programmable	39+ Programmable
DPL Codes	84+ Inverted DPL Codes	84+ Inverted DPL Codes
Input Voltage -- Repeater	110/220 Vac/12 Vdc	110/220 Vac/12 Vdc
Input Voltage -- Transceiver	12 Vdc +/- 10%	12 Vdc +/- 10%
Input Current Repeater (@ 1 Vac and 2W Operation)		
TX/RX Standby	215 mA	215 mA
	33 mA	33 mA
Input Current Transceiver (@ 12 Vdc and 2W Operation)		
TX/RX Standby	1.3 A	1.3 A
	200 mA	200 mA

Product Specifications	UHF 25 kHz	UHF 12.5 kHz
<b>Transmitter</b>		
Frequency Range (MHz)	450 – 455 MHz	450 – 455 MHz
Carrier RF Output	2.0 Watts	2.0 Watts
Frequency Stability	<b>+/- 1.5 PPM (-30 °C to + 60 °C)</b>	<b>+/- 1.5 PPM (-30 °C to + 60 °C)</b>
Modulation	Direct FM	Direct FM
Deviation (Modulation Limiting)	<b>± 5.0 kHz</b>	<b>± 2.5 kHz</b>
FM Hum & Noise	- 50 dB	- 45 dB
Adjacent Channel Power	60 dBc	60 dBc
Radiated Spurious Emissions	< - 13 dBm	< -20 dBm

Product Specifications	UHF 25 kHz	UHF 12.5 kHz
<b>Receiver</b>		
Frequency Range (MHz)	465 – 470 MHz	465 – 470 MHz
Receiving System	Programmable	Programmable
Frequency Stability	<b>+/- 1.5 PPM (- 30 °C to + 60 °C)</b>	<b>+/- 1.5 PPM (- 30 °C to + 60 °C)</b>
Audio Frequency	300 Hz to 3 kHz	300 Hz to 3 kHz
Sensitivity (12 dB SINAD)	- 119 dBm (0.25 uV)	- 119 dBm (0.25 uV)

Product Specifications	UHF 25 kHz	UHF 12.5 kHz
Selectivity (Adjacent Channel Selectivity)	- 75 dB	- 70 dB
Intermodulation Rejection	- 70 dB	- 70 dB
Spurious Response Rejection (blocking 1 MHz)	- 90 dB	- 90 dB
Radiated Spurious Emissions	- 57 dBm	- 57 dBm
Input impedance	50 Ohms	50 Ohms

Other Product Specifications	UHF 25 kHz	UHF 12.5 kHz
Li-On Battery Solution	Available as an accessory	Available as an accessory
Alkaline Battery Frame Solution	Yes	Yes
Dimensions (H x W X D) (inches):	<b>4.7 H x 7.4 W x 2.0 D</b>	<b>4.7 H x 7.4 W x 2.0 D</b>
Weight		
Repeater with Alkaline Frame	<b>2.1 lbs</b>	<b>2.1 lbs</b>
Repeater with Li-On Frame	<b>2.0 lbs</b>	<b>2.0 lbs</b>
Average Battery Life @ 100% duty (20%/80% operation):		
With Alkaline Frame	16 Hours	16 Hours
With Li-On Battery	16 Hours (2400 mAh)	16 Hours (2400 mAh)
Charging Time (@ repeater 100% charging and 0% transmitting):	3.5 Hours (2400 mAh)	3.5 Hours (2400 mAh)

810 Military Standards	RPX Series									
	810-C		810-D		810-E		810-F		810-G	
	Method	Procedure	Method	Procedure	Method	Procedure	Method	Procedure	Method	Procedure
Low Pressure	500.1	1	500.2	2	500.3	2	500.4	1	500.5	1
High Temperature	501.1	1, 2	501.2	1, 2	501.3	1, 2	501.4	1, 2	501.5	1, 2
Low Temperature	502.1	1	502.2	1, 2	502.3	1, 2	502.4	1, 2	502.5	1, 2
Temperature Shock	503.1	1	503.2	1	503.3	1	503.4	1	503.5	1
Solar Radiation	505.1	1	505.2	1	505.3	1	505.4	1	505.5	1
Rain	506.1	1, 2	506.2	1, 2	506.3	1, 2	506.4	1, 2, 3	506.5	1, 2, 3
Humidity	507.1	2	507.2	2, 3	507.3	2, 3	507.4	1	507.5	1
Salt Fog	509.1	1	509.2	1	509.3	1	509.4	1	509.5	1
Dust	510.1	1	510.2	1	510.3	1	510.4	1	510.5	1
Vibration	514.2	8, 10	514.3	1	514.4	1	514.5	1	514.6	1
Shock	516.2	1, 2, 5	516.3	1, 4	516.4	1, 4	516.5	1	516.6	1

RPX Series Environmental Specs	
Operating Temperature	- 30 °C to + 60 °C (Repeater)
Sealing	IP55
Shock & Vibration	Polycarbonate Housing passes EIA 603
Dust & Humidity	Satisfied EIA 603
UL Certification	UL Type 1

## APPENDIX B: REPEATER LIGHTNING PROTECTION

### How To Minimize Lightning Damage for RPX Repeater Series™ System.

#### General Information:

- Please refer to Motorola R56 (part number: 6881089E50) Standards and Guidelines for more in-depth details.
- Make sure installation meet all Local and State building codes in you area.

#### AC Line Requirements:

- A commercial grade AC surge protector is recommended for use with this product when the power adapter is used.

Recommended part for this product:

Manufacturer: Transtector

Product Model: DSSL

#### RF Protection Instructions:

1. Insert a Lightning Protector between the repeater device and the antenna.
2. The Lightning Protector must be grounded using #6AWG.
3. Please refer to “Figure 23. Direct Antenna Mount (Dipole Antenna P/N HKAE4000)” on page 69 and “Figure 24. Remote Co-Axial Cable Mount (Magnetic Mount Antenna Kit P/N HKKN4022)” on page 69 for more connection details.

**Note:** Port 2 (Mounting and ground nut side) attaches to repeater port.

The recommended RF Protector part number for this product is:

Manufacturer: HUBER+SUHNER

Part Number:3406.17.0029



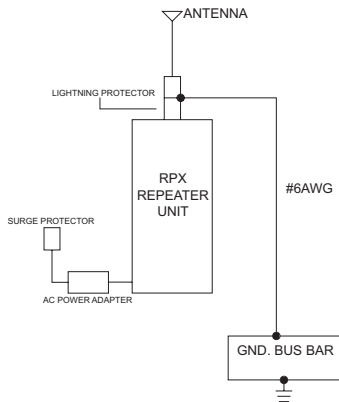

**Figure 23. Direct Antenna Mount (Dipole Antenna P/N HKAE4000)**

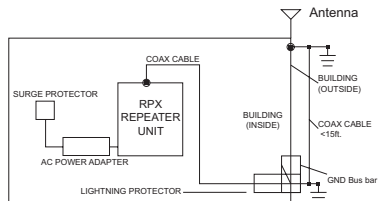

**Figure 24. Remote Co-Axial Cable Mount (Magnetic Mount Antenna Kit P/N HKKN4022)**





Motorola Inc.  
1301 E. Algonquin Rd.  
Schaumburg, IL 60196-1078 U.S.A.

MOTOROLA, the RPX Repeater Series™ and the Stylized M Logo are registered in the U.S. Patent and Trademark Office. All other product or service names are the property of their respective owners.

© 2009, 2010 by Motorola, Inc.

All rights reserved.

Printed in Malaysia.



**68012000018-B**