



PM400™

Commercial Series
Two-Way Radio User Guide
Manuel de l'utilisateur
de la radio bidirectionnelle

COMPUTER SOFTWARE COPYRIGHTS

The Motorola products described in this manual may include copyrighted Motorola computer programs stored in semiconductor memories or other media. Laws in the United States and other countries preserve for Motorola certain exclusive rights for copyrighted computer programs including, but not limited to, the exclusive right to copy or reproduce in any form the copyrighted computer program. Accordingly, any copyrighted Motorola computer programs contained in the Motorola products described in this manual may not be copied, reproduced, modified, reverse-engineered, or distributed in any manner without the express written permission of Motorola. Furthermore, the purchase of Motorola products shall not be deemed to grant either directly or by implication, estoppel, or otherwise, any license under the copyrights, patents or patent applications of Motorola, except for the normal non-exclusive license to use that arises by operation of law in the sale of a product.

CONTENTS

Computer Software Copyrights . . . inside cover		Getting Started 21	
Safety 5		Turn the Radio On or Off 21	
Product Safety and RF Exposure		Adjust the Volume 21	
Compliance 5		Select an LTR Channel/Talkgroup 22	
Introduction 7		Select a Conventional Channel 22	
Conventional Radio Systems 7		Receive a Conventional or LTR Call 22	
Trunked Radio Systems 7		Monitor 23	
LTR Trunked Systems 7		Silent Monitor 23	
PM400 Radio Features 8		Open Squelch Monitor 23	
Radio-Wide Features 8		Transmit an LTR Call 24	
LTR Trunked Features 8		Transmit a Conventional Call 24	
Conventional Signaling Features 8		Repeater or Talkaround Mode 25	
Radio Overview 11		Revert Memory Channel (1 & 2) 25	
LED Indicators 12		Store Memory Channel (1 & 2) 25	
Display 12		Home Revert AutoKey (1 & 2) 26	
Optional Enhanced Keypad Microphone		Set Local or Distance Mode 26	
(RMN5029) 13		VOX Operation 26	
Indicator Tones 15		Program PL/DPL Codes 27	
Programmable Buttons 16		Radio Calls 29	
Menu Buttons 19		Selective Radio Inhibit 29	
Menu Button 19		Receive a Selective Call	
Menu Scroll Buttons 19		(Conventional Operation Only) 29	
Navigate the Menu 19		Send a Selective Call	
		(Conventional Operation Only) 30	
		Receive a Call Alert™ Page	
		(Conventional Operation Only) 30	

Send a Call Alert Page (Conventional Operation Only)	31	Add an Entry	45
Repeater Access	31	Delete an Entry	45
Radio Check	32	Edit an Entry	46
Emergency Alerts	32	Edit Access/Deaccess Codes	47
Send an Emergency Alert.	32	Tone Preferences	49
Clear an Emergency Alert.	32	Tones On/Off	51
Scan	33	Keypad On/Off Tones	51
Talkback	33	Call Tone Tagging (Conventional Operation Only)	52
Start System Scan	34	Escalert (Conventional Operation Only)	53
Stop System Scan	34	User Settings	55
Start Auto Scan	35	Set Squelch Level	57
Stop Auto Scan.	35	Set Power Level	57
Delete a Nuisance Channel/Talkgroup.	35	Option Board On/Off	58
Restore Channels/Talkgroups to the Scan List.	36	Set the Backlight Intensity	59
Edit a Scan List.	36	Display the Software Version.	59
Add or Delete Channels/Talkgroups in a Scan List.	37	Warranty	61
Prioritize a Channel/Talkgroup in a Scan List	38	Limited Warranty	61
Phone	41	Accessories	65
Receive a Phone Call	41	Antennas	65
Make a Phone Call	43	Alarm and Accessories	65
Edit the Phone List	44	Audio	65

Cables	66
Control Station	66
Data - CES Wireless Technologies	66
Mounting	67
Public Address	67

Notes:

SAFETY

PRODUCT SAFETY AND RF EXPOSURE COMPLIANCE



Before using this product, read the operating instructions for safe usage contained in the Product Safety and RF Exposure booklet enclosed with your radio.

ATTENTION!

This radio is restricted to occupational use only to satisfy FCC RF energy exposure requirements. Before using this product, read the RF energy awareness information and operating instructions in the Product Safety and RF Exposure booklet enclosed with your radio (Motorola Publication part number 68P81095C99) to ensure compliance with RF energy exposure limits.

For a list of Motorola-approved antennas, batteries, and other accessories, visit the following web site which lists approved accessories: <http://www.motorola.com/cgiss/index.shtml>.

Notes:

INTRODUCTION

Your PM400™ radio can operate on both LTR® trunked and conventional radio systems. This radio combines the very latest in two-way technology while delivering outstanding functionality at the touch of a button.

CONVENTIONAL RADIO SYSTEMS

Conventional typically refers to radio-to-radio communications through a single channel. Conventional systems also allow radio users to extend communication coverage by relaying their messages through a repeater. To ensure coordinated use by multiple users, each radio user must monitor the channel or repeater before transmitting to verify that the system is not currently busy.

TRUNKED RADIO SYSTEMS

A trunked radio system allows a large number of users to share a relatively small number of frequencies or repeaters without interfering with each other. The airtime of all the repeaters in a trunked system is pooled, which maximizes the amount of airtime available to

any one radio and minimizes channel/talkgroup congestion.

Some of the benefits of trunked two-way radio systems are:

- No channel/talkgroup monitoring required prior to transmission
- Improved system access
- Automatic channel/talkgroup selection
- Increased privacy among members of the same group

LTR Trunked Systems

LTR (Logic Trunked Radio) is a transmission-based trunking protocol developed by the E. F. Johnson Company for primarily single-site trunking applications. In transmission trunking, a repeater is used for only the duration of a single transmission. Once a transmission is completed, that repeater becomes available to other users. This means that a conversation comprised of many transmissions may occur over several different channels/talkgroups within the LTR system. This method of trunking provides system efficiency by making repeaters available to all users after every transmission.

When an LTR trunked radio user wants to communicate with another radio, the user's

radio sends a “channel/talkgroup request” to the home repeater. The system then sends back a “channel/talkgroup grant” to the user’s radio. The channel/talkgroup grant message contains the number of a “go to” repeater to tell the radio which repeater to use. This “go to” repeater can be the same as the radio’s home repeater or another repeater in the system.

The radio uses the “go to” repeater for transmission. Once the transmission has ended, this repeater is available for other users.

PM400 RADIO FEATURES

Radio-Wide Features

- 64 Conventional Channels
- Up to 10 Sites and 100 Talkgroups
- Up to 20 Repeaters per Site
- 8-Character Alphanumeric Display
- 4 Programmable Feature Buttons
- 2 Memory Channels
- Telephone Interconnect
- User-programmable Phone, Scan, and TPL/DPL Lists
- Option Board Expandability
- Busy Channel Lockout
- High/Low Power Settings

- Transmit Time-Out Timer
- Monitor and Sticky Permanent Monitor
- System Scan with 2 Priority Levels and Revert Scan
- Companding Mode
- Group Data Receive

LTR Trunked Features

- MDC 1200 Signaling

- Selective Radio Inhibit Decode	- DOS
- Radio Check Decode	- LTR Data Revert Mode
- MDC Pre-Time	- Universal ID Receive
- PTT ID Encode/Decode	

Conventional Signaling Features

- MDC 1200 Signaling

- Emergency Alert Encode	- PTT ID Encode/Decode
- Selective Radio Inhibit Decode	

- Quik-Call II Signaling

<ul style="list-style-type: none">- Call Alert Encode/Decode- Selective Call Encode/Decode	<ul style="list-style-type: none">- Radio Call List- Call Tone Tagging
---	---

- DTMF Signaling

<ul style="list-style-type: none">- DTMF PTT ID Encode- DTMF Call Alert Encode	<ul style="list-style-type: none">- DTMF Selective Call Encode
---	--

Notes:

RADIO OVERVIEW

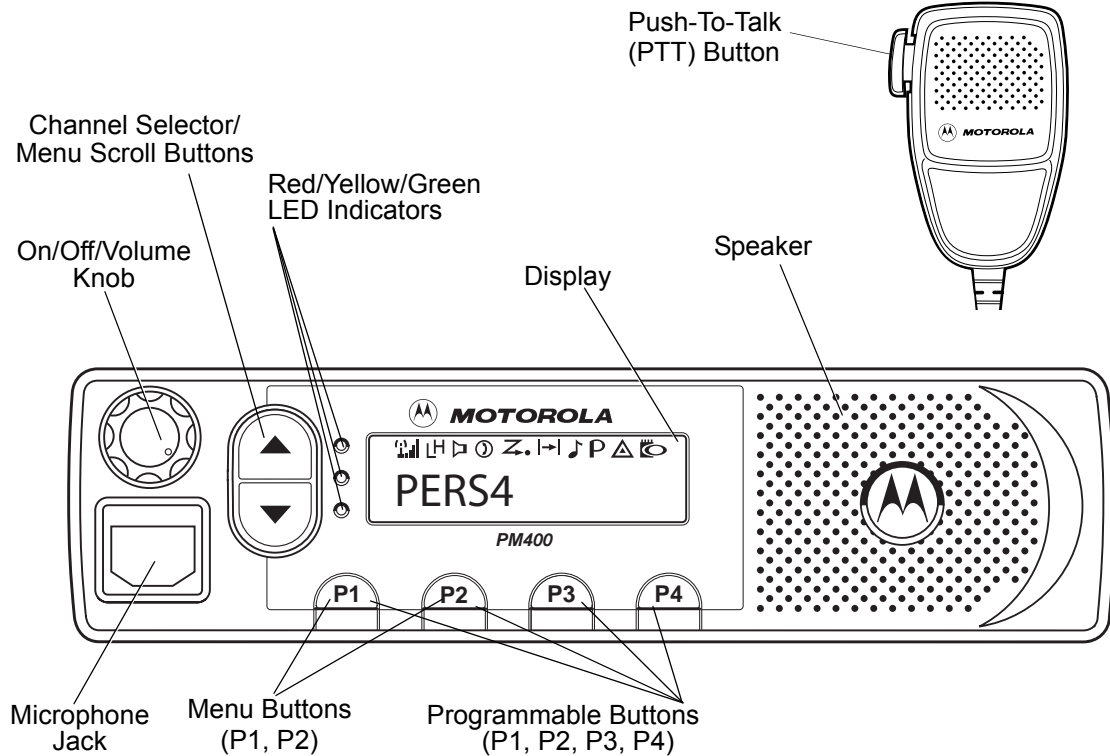

LED INDICATORS





Indicates power up, transmit, receive, scan, monitor status, channel/talkgroup busy, Call Alert™ receive/transmit, and Selective Call receive/transmit.

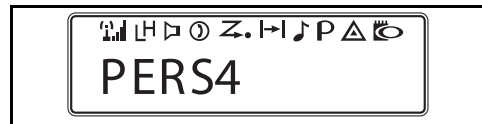





LED State/Color	Indication
Radio Call	
Red	Transmitting
Flashing Red	Receiving
Flashing Red	Channel/Talkgroup Busy
Scan	
Flashing Green	Scanning for activity
Call Alert	
Flashing Yellow	Indicates receiving a Call Alert
Yellow	Indicates sending a Call Alert
Selective Call	
Flashing Yellow	Indicates receiving a Selective Call
Yellow	Indicates sending a Selective Call
Sticky Monitor/Open Squelch	
Yellow	While monitoring

DISPLAY



The top row displays menu and radio status information:

Symbol	Indication
 Signal Strength	The more bars, the stronger the signal being received by your radio.
 Power Level	Low Power “L” or High Power “H” is activated.
 Monitor	The selected channel is being monitored.
 Phone	Phone mode is selected.
 Scan	Indicates that the Scan feature has been activated.

Symbol	Indication
 Priority 1 Scan (• flashing)	Indicates scan has stopped and landed on an active Priority 1 channel/talkgroup.
 Priority 2 Scan (• steady)	Indicates scan has stopped and landed on an active Priority 2 channel/talkgroup.
 Talkaround	You are not transmitting through a repeater
 Call Received	A Selective Call or Call Alert has been received.
 Not Used	Not Used
 Emergency	An Emergency Alarm is being sent.
 Option Board	An Option Board has been activated.

OPTIONAL ENHANCED KEYPAD MICROPHONE (RMN5029)

Your radio may be ordered with an optional DTMF (Dual-Tone Multi-Frequency) microphone that has a direct entry keypad. This keypad microphone has three programmable buttons (A, B, C) below the keypad that can be programmed to conveniently activate select radio features.

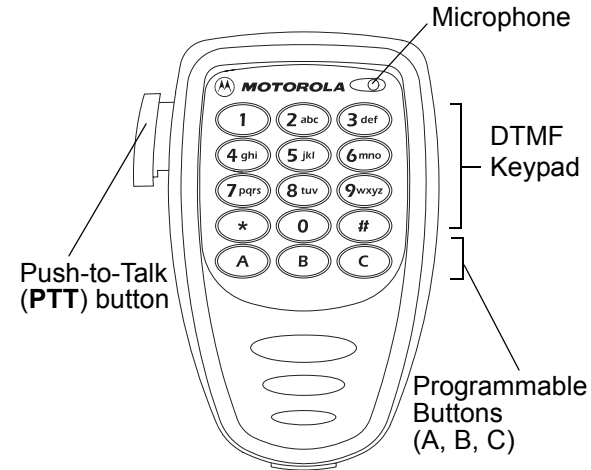

The keypad is used for:

- Dialing a phone number.
- Entering information when programming phone lists.
- Directly accessing preprogrammed features (see page 17).







Each key can generate several different characters. For example, to enter the character “C,” press the **2_{abc}** button three times. (Refer to the Entering Characters Using the DTMF Microphone Keypad table.)

Entering Characters Using the DTMF Microphone Keypad

Number of Times Button is Pressed					
Button	1	2	3	4	5
0	0				
1	1	/	\		
2_{abc}	A	B	C	2	
3_{def}	D	E	F	3	
4_{ghi}	G	H	I	4	
5_{jkl}	J	K	L	5	
6_{mno}	M	N	O	6	
7_{pqrs}	P	Q	R	S	7
8_{tuv}	T	U	V	8	
9_{wxyz}	W	X	Y	Z	9
*	*	<	>		
#	#	+	-	-	

INDICATOR TONES

High pitched tone  Low pitched tone 

	Self Test Pass Tone
	Self Test Fail Tone
	Positive Indicator Tone
	Negative Indicator Tone
	Good Key Press
	Bad Key Press





Some programmable buttons use tones to indicate one of two modes:

Programmable Buttons	Positive Indicator Tone	Negative Indicator Tone
Scan	Start	Stop
Power Level	High	Low
Squelch	Tight	Normal
Repeater/ Talkaround	Does not use repeater	Uses repeater
VOX	Enabled	Disabled
Local/Distance	Local	Distance
Sticky Monitor/ Open Squelch	—	Enabled
Revert Memory Channel (1&2)	—	Enabled
Store Memory Channel (1&2)	—	Stored
Home Revert AutoKey (1&2)	—	Enabled
Menu Mode 	—	Accessed
Radio Call	—	Enabled
Scan List Edit	—	Enabled
Speed Dial	—	Enabled

Programmable Buttons	Positive Indicator Tone	Negative Indicator Tone
Phone Mode	—	Enabled
Option Board	Enabled	Disabled
Escalart	Enabled	Disabled

PROGRAMMABLE BUTTONS

Your radio has four programmable buttons. Your dealer/programmer can program these buttons as shortcuts to various radio features. Check with your dealer/programmer for a complete list of functions your radio supports. Programmable buttons include:

- The four front buttons (, , , and )
- The three buttons (A, B, and C) of the optional DTMF microphone.

Some buttons can access up to two features, depending on the type of button press:

- **Short Press** — quickly pressing and releasing the programmable buttons,

or

- **Long Press** — pressing and holding the programmable buttons for a preprogrammed period of time,

or

- **Hold Down** — pressing and holding down the programmable buttons while checking status or making adjustments.

The table on page 17 summarizes the programmable features available and shows the page number where the feature is explained.

In the “Button” column, have your dealer/programmer record the name of the programmable button next to the feature that has been programmed to it.

The dealer/programmer can use the abbreviations (P1, P2, P3, or P4) shown in the radio illustration on page 11.





Also, where appropriate, have your dealer/programmer indicate whether the button press requires a short press, a long press, or needs to be held down.

Programmable Features

Function	Indicator	Short Press	Long Press	Hold Down	Page	Button
Menu Mode	—	(P2) button enters Menu Mode and selects menu options. (P1) button is automatically re-assigned to exit Menu Mode.†		—	19	(P2)
Volume Set	—	—	—	Sounds a tone for adjusting your radio's volume level.	21	
Monitor	▶	Toggle silent monitor operation (also turn off open squelch monitor when it has been activated).	Turn on open squelch monitor.	—	23	
Repeater/ Talkaround	→	Toggle between using a repeater or transmitting directly to another radio.†		—	25	
Revert Memory Channel (1&2)	—	Provides direct channel/talkgroup access.†		—	25	
Store Memory Channel (1&2)		—	Stores current channel/talkgroup.	—	25	
Home Revert AutoKey (1&2)	—	If a Revert Memory Channel is an LTR talkgroup, the radio keys-up and transmits an MDC PTT ID. If a Revert Memory Channel is a conventional channel, it does not key-up.†		—	26	

† This function is activated by EITHER a short OR a long press, but not both.





Programmable Features (Continued)

Function	Indicator	Short Press	Long Press	Hold Down	Page	Button
Local/Distance	—	Toggle between local mode and distance mode.†		—	26	
Voice Operated Transmission (VOX)	—	Toggle VOX on and off.†		—	26	
Radio Call	—	Directly access the radio call menu.†		—	30,30	
Scan/ Nuisance Channel/ Talkgroup Delete		Toggle scan on and off.	Delete a nuisance channel/talkgroup while scanning.	—	34, 35	
Edit Scan List	—	Directly access the Scan Edit menu to add, delete, or prioritize channels/talkgroups.†		—	36	
Phone		Directly access Phone mode.†		—	41,43	
Speed Dial		Directly Access Phone mode to quickly access phone list for speed dial.†		—	44	
Escalart On/Off	—	Toggles escalart on and off.†		—	53	
Squelch	—	Toggles squelch level between tight and normal squelch.†		—	57	
Power Level	LH	Toggle transmit power level between High and Low.†		—	57	
Option Board		Toggle the option board on and off.†		—	58	

† This function is activated by EITHER a short OR a long press, but not both.

MENU BUTTONS

Menu Button

If preprogrammed by your dealer/programmer, the two front buttons ( and ) can be used, in conjunction with other programmable features, to access and select menu options () and exit menu mode (.

The  button can be preprogrammed by your dealer/programmer to either a short or long press to access the Menu Mode.



Menu Scroll Buttons







Used to scroll while in Menu Mode.

Refer to the menu navigation chart for menu selectable features at the back of this manual.

Navigate the Menu

 or  to scroll through the menu options. If you scroll past the last option, the selection wraps around and starts again.



When you reach the required option, a short press of the  button selects that option and enters the Sub-menu.

 or  to scroll through the sub-menu options. Select the option with a short press of the  button.

Exit the Menu

While in Menu Mode, the  button is automatically assigned to completely exit the Menu Mode by a long press or by a series of short presses to exit from a sub-level of the menu hierarchy.

The radio also exits the menu mode if there have been no inputs via the navigation buttons for the “Inactivity Time” or after a selection has been made.

Once you have exited Menu Mode, the  and  buttons return to normal programmable condition.

Notes:

GETTING STARTED

TURN THE RADIO ON OR OFF

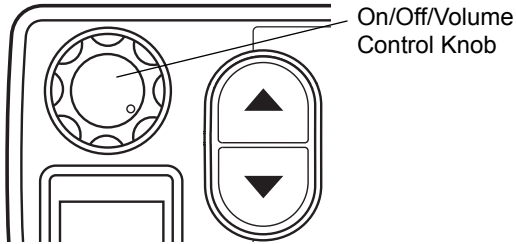

ON	OFF
<p>Rotate the On/Off/Volume Control knob clockwise. If power-up is successful, you will hear the Self-Test Pass Tone (<input type="checkbox"/><input type="checkbox"/>) and see the green LED indicator and display icons light momentarily. If the radio fails to power up, you will hear the Self Test Fail Tone (<input type="checkbox"/>). The radio will need to be returned for re-programming.</p>	<p>Rotate the On/Off/Volume Control knob counterclockwise until you hear a click and both the display and LED indicators turn off.</p>

ADJUST THE VOLUME

Turn the **On/Off/Volume Control** knob clockwise to increase the volume, or counterclockwise to decrease the volume.

– or –



Note: Your dealer/programmer can preprogram one of the programmable buttons to Volume Set.

- 1 Hold down the **Volume Set** button (see page 17).
 - You will hear a continuous tone.
- 2 Turn the **On/Off/Volume Control** knob to the desired volume level.
- 3 Release the **Volume Set** button.

SELECT AN LTR CHANNEL/ TALKGROUP

Your PM400 radio can be programmed with up to 10 LTR sites and a maximum of 100 talkgroups, in total, across one or more sites (up to a total of 10 sites).



To select an LTR Channel/Talkgroup:

 or  to select the appropriate LTR channel/talkgroup.



SELECT A CONVENTIONAL CHANNEL

Up to a total of 64 channels can be programmed into your radio.

Select a Channel

 or  to select the desired channel.

RECEIVE A CONVENTIONAL OR LTR CALL

- 1 Turn your radio on.
- 2 Adjust the radio's volume, if necessary (see page 21).
- 3  or  to select the desired channel/talkgroup.
 - Make sure the **PTT** button is released.
- 4 Listen for voice activity.
 - The red LED indicator flashes while your radio is receiving.
- 5 To respond, hold the microphone vertically 1 to 2 inches (2.5 to 5 cm) from your mouth. Press the **PTT** button to talk; release it to listen.

MONITOR

It is important to monitor traffic before transmitting to ensure that you do not “talk over” someone who is already transmitting.

Silent Monitor



- 1 A short press of the preprogrammed **Monitor** button places the radio in Silent Monitor mode.
 - You hear a high-pitched tone.
 - 2 A short press of the **Monitor** button cancels Silent Monitor mode and returns the radio to normal operation.
-

Open Squelch Monitor



- 1 To place the radio in Open Squelch mode, press and hold the preprogrammed **Monitor** button until you hear a high-pitched tone.
 - If no activity is present, you will hear “white noise.”
 - 2 Momentarily press the **Monitor** button to return to normal operation.
-

Note: Depending on how your radio has been programmed, per channel for transmit and receive conditions, when the microphone has been taken off-hook, the radio will go into Open Squelch mode.

TRANSMIT AN LTR CALL

- 1  or  to select the appropriate LTR channel/talkgroup.
 - 2 Hold the microphone in a vertical position at a distance of about 1 to 2 inches (2.5 to 5 cm) from your mouth.
 - 3 Press and hold the **PTT** button.
–or–
Press and release the **PTT** button and wait 3 seconds.
 - If access to the trunked system was successful, the red LED indicator lights steady.
 - If access to the trunked system was unsuccessful, the red LED indicator flashes, indicating that the system was busy or out-of-range.
 - 4 With the **PTT** button depressed, speak clearly into the microphone
 - 5 Release the **PTT** button to listen.
-

TRANSMIT A CONVENTIONAL CALL

- 1 Turn your radio on.
 - 2  or  to select the desired channel.
 - 3 Hold the microphone vertically 1 to 2 inches (2.5 to 5 cm) from your mouth. Press the **PTT** button to talk.
 - The red LED indicator lights steady while the call is being sent.
 - 4 Release the **PTT** button to listen.
-

REPEATER OR TALKAROUND |→| MODE

Talkaround Mode enables you to communicate with another radio when either:

- The repeater is not operating.
 - or –
- Your radio is out of the repeater's range but within communicating distance of another radio.

Note: The |→| symbol appears on the display when Talkaround Mode is selected.

Select either Repeater Mode or Talkaround Mode



Press the preprogrammed **Repeater/ Talkaround** button (see page 17) to toggle between Repeater Mode and Talkaround Mode.

– or –

1  to enter menu mode.

2  or  until 

3  to select the current setting.

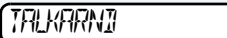
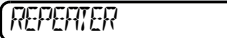
4  or  until 
– or – until 

5  to select the current setting.

REVERT MEMORY CHANNEL (1 & 2)



The Revert Memory Channel feature allows you to instantly access up to two of your favorite channels/talkgroups at the touch of a button.

To Activate Revert Memory Channel

Press the preprogrammed **Revert Memory Channel 1** button or **Revert Memory Channel 2** button (see page 17).

STORE MEMORY CHANNEL (1 & 2)

The Store Memory Channel feature allows you to store a channel/talkgroup for the Revert Memory Channel feature.

 or  to select the desired channel/talkgroup. Press the preprogrammed **Store Memory Channel 1** button or **Store Memory Channel 2** button to store that channel/talkgroup (see page 17).

HOME REVERT AUTOKEY (1 & 2)

If a Revert Memory Channel is an LTR talkgroup, the Home Revert AutoKey feature automatically keys-up and transmits an MDC PTT ID. If a Revert Memory Channel is programmed as a Conventional channel, the radio will not key-up (see page 17).

SET LOCAL OR DISTANCE MODE

Use this feature between Local mode (low sensitivity) and Distance mode (normal sensitivity). Local mode reduces interference from other radios in close proximity. Distance mode improves the radio's range.

Press the preprogrammed **Local/Distance** button (see page 17) to toggle between Local and Distance mode.

VOX OPERATION

When hands-free operation is desired, your radio can transmit by voice alone using the VOX feature when you speak through a voice activated external microphone that is connected to your radio.



Note: A voice activated external microphone must be connected to your radio prior to power-up of the radio in order to activate the VOX feature.

To enable or disable VOX operation on a channel/talkgroup, press the preprogrammed **VOX** button (see page 18).



Note: Pressing the **PTT** button disables VOX.

– or –



You can select channels/talkgroups to enable or disable VOX as preprogrammed by your dealer/programmer.

- 1  or  to select a channel/talkgroup that has been preprogrammed to enable VOX.



Note: Pressing the **PTT** button disables VOX.

- 2  or  to select a channel/talkgroup that has **not** been preprogrammed to disable VOX.

You can select channels/talkgroups to enable or disable VOX as preprogrammed by your dealer/programmer.

- 1  or  to select a channel/talkgroup that has been preprogrammed to enable VOX.

Note: Pressing the **PTT** button disables VOX.

- 2  or  to select a channel/talkgroup that has **not** been preprogrammed to disable VOX.

PROGRAM PL/DPL CODES

Use this feature to edit the Private-Line/Digital Private-Line codes for a selected channel/talkgroup.

- 1  to enter menu mode.

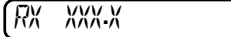

- 2  or  until 

- 3  to select 

- 4  or  until 

– or – until 

- 5  to select the current setting.

- 6  or  to scroll through the standard TPL frequencies or DPL codes.

– or –

Enter a non-standard or standard 4-digit TPL frequency or the 3-digit octal code (numbers 0-7 only) for DPL via the DTMF microphone keypad.

- 7  to confirm selection.

- 8  until you exit menu mode.

Notes:

RADIO CALLS

SELECTIVE RADIO INHIBIT

Your radio is equipped with a security feature that can temporarily render the unit inoperative when an inhibit signal is sent from the base station.

This feature is commonly used to disable radios:

- In case of theft
- When your vehicle is being serviced
- For system control reasons

When your radio has been rendered inoperative by the base station, all controls will be inoperative except for the **On/Off/Volume** knob and the display shows INHIBIT.

RECEIVE A SELECTIVE CALL 🎵 (CONVENTIONAL OPERATION ONLY)

When you receive a Selective Call:

- The display shows 🎵 and the preprogrammed name or ID of the calling radio.
- The yellow LED indicator flashes, if programmed by your dealer/programmer.
- You hear two high-pitched tones.

1 To acknowledge the call, press and release the **PTT** button.













2 Press and hold the **PTT** button to talk; release to listen.

SEND A SELECTIVE CALL (CONVENTIONAL OPERATION ONLY)

You can send a Selective Call to a particular radio or to a group of radios, as programmed by your dealer/programmer.

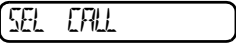
Press the preprogrammed **Radio Call** button (see page 18), and proceed to step 4.

– or –

- 1  to enter menu mode
- 2  or  until 
- 3  to select 
- 4  or  until 
- 5  to select 
- 6  or  to locate the desired ID in the Call List.

- or -

When using the enhanced keypad microphone, enter a valid DTMF digit to move to that location in the list.

- 7 Press the **PTT** button to send the call.
- 8 Press and hold the **PTT** button to talk; release to listen.
- 9 When the call is completed,  until you exit menu mode.

RECEIVE A CALL ALERT™ PAGE (CONVENTIONAL OPERATION ONLY)

When you receive a Call Alert page:

- The display shows  and the preprogrammed name or ID of the calling radio.
- The yellow LED indicator flashes, if programmed by your dealer/programmer.
- You hear four high-pitched tones.









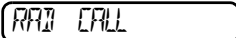

To acknowledge the page, press and release the **PTT** button; to cancel the page, press any other key.

SEND A CALL ALERT PAGE (CONVENTIONAL OPERATION ONLY)

You can alert another person by sending a Call Alert page.

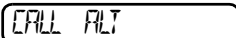
Press the preprogrammed **Radio Call** button (see page 18) and proceed to step 4.

– or –

- 1  to enter menu mode
- 2  or  until 
- 3  to select 
- 4  or  until 
- 5  to select 
- 6  or  to locate the desired ID in the Call List.

- or -

When using the enhanced keypad microphone, enter a valid DTMF digit to move to that location in the list.

- 7 Press the **PTT** button to send the page.

- 8 When the page is completed,  until you exit menu mode.

REPEATER ACCESS Use with Enhanced Keypad Microphone (RMN5029)

Use this feature to send DTMF tones to a repeater.

- 1 Press and hold the **PTT** button and enter your access code using the DTMF keypad.
- 2 Press and release the required DTMF buttons.
- 3 Release the microphone's **PTT** button.

RADIO CHECK

Radio Check allows you to determine if a radio is within the range of the trunked system and turned on, without disturbing the user of that radio. This feature can also be used when attempts with Selective Call and Call Alert fail.

EMERGENCY ALERTS

Your radio offers choices for initiating and responding to Emergency Alert communications. An Emergency Alert can be programmed to:

- Show  and sound a tone
–or–
- Show the normal display
–or–
- Activate the microphone so that all activity can be transmitted (for a predetermined amount of time). See your dealer/programmer for more information.

All emergency features are preprogrammed. See your dealer/programmer for further information on the emergency features that are available.

SEND AN EMERGENCY ALERT

A priority Emergency Alert can be sent to a specific radio or dispatch center by pressing either a foot switch or a push button accessory.

- The display shows:



Note: Emergency alerts have priority over all other calls.

CLEAR AN EMERGENCY ALERT

An Emergency Alert can be cleared by long pressing either a foot switch or a push button accessory.

SCAN

Your radio is equipped with the Scan feature, which allows you to search for, lock onto, and monitor voice activity on channels/talkgroups. Scan lists are assigned per channel/talkgroup, by your dealer/programmer. Your radio automatically switches to a channel/talkgroup, within that scan list, when it detects activity. You can also edit these lists through your radio's menu (see page 36).

- The green LED indicator blinks during scan mode; it stops blinking when the radio switches to an active channel/talkgroup.
- The  symbol appears on the display while in scan mode.
- Your dealer/programmer can preprogram your radio where if the microphone is taken off-hook while in Scan mode, the scanning activity becomes suspended until the microphone is replaced.

There are two ways that your radio scans:

- System Scan (manual)
- Auto Scan (automatic)

TALKBACK



The Talkback feature allows you to respond to a transmission while scanning. If transmission is detected on a channel/talkgroup while scanning, the radio will stop and land on that channel/talkgroup for a preprogrammed period of time after activity has ceased. This is referred to as "hangtime". During this hangtime you may respond by pressing the **PTT** button.

Note: The LED scan indicator stops blinking while the radio is in hangtime. If the **PTT** button is not pressed during the preprogrammed hangtime, the radio reverts back to scan.

START SYSTEM SCAN ↘

Press the preprogrammed **Scan** button to start System Scan (see page 18).

– or –

1  or  to select a channel/talkgroup that contains a Scan list.

2  to enter menu mode.

3  or  until 

4  to select 

The display shows the current scan status.

5  or  until 

6  to select the current setting.

STOP SYSTEM SCAN

Press the preprogrammed **Scan** button to stop System Scan (see page 18).

– or –

1  to enter menu mode.

2  or  until 

3  to select 

The display shows the current scan status.

4  or  until 



5  to select the current setting.

- The ↘ symbol disappears from the display.



Note: Your dealer/programmer can preprogram your radio when exiting System Scan to automatically revert to the last scan channel/talkgroup that had activity on it or to automatically revert to the channel/talkgroup where scan was initiated.

START AUTO SCAN

Auto Scan automatically starts scanning once a channel/talkgroup with Auto Scan enabled is selected.

 or  to select a channel/talkgroup that has been preprogrammed for Auto Scan by your dealer/programmer.

STOP AUTO SCAN

 or  to select a channel/talkgroup that has not been preprogrammed for Auto Scan by your dealer/programmer.

- The  symbol disappears from the display.

DELETE A NUISANCE CHANNEL/ TALKGROUP

Note: Your dealer/programmer must preprogram a button to **Nuisance Delete** to access this feature.

If a channel/talkgroup continually generates unwanted calls or noise (a “nuisance” channel/talkgroup), you can temporarily remove it from the scan list:

- 1 While the radio is on the nuisance channel/talkgroup, press the preprogrammed **Nuisance Channel Delete** button until you hear a tone.
- 2 Release the **Nuisance Channel Delete** button. The nuisance channel/talkgroup is deleted.

Note: You cannot temporarily delete the channel/talkgroup that has been preprogrammed by your dealer/programmer as your designated scan channel/talkgroup, a priority channel/talkgroup, or the last remaining channel/talkgroup in the scan list.



Restore Channels/Talkgroups to the Scan List

- 1 Power off the radio. Once the radio is powered on again, the deleted nuisance channels/talkgroups are restored to the scan list.

–or–

- 2 Press the preprogrammed **Scan** button to stop the scan.
- 3 Press the preprogrammed **Scan** button again to start scanning again. The deleted nuisance channels/talkgroups are restored to the scan list.

– or –



- 4  or  to select a channel/talkgroup that has **not** been preprogrammed by your dealer/programmer to stop Scan. Once you return to the original channel/talkgroup, the deleted nuisance channels/talkgroups are restored to the scan list.

EDIT A SCAN LIST

Your radio can support up to 16 Scan lists. Each Scan list can contain up to a combination of 16 channels/talkgroups. The same channel/talkgroup can be included in several Scan lists, and the same Scan list can be assigned to several channels/talkgroups. Scan lists are assigned per channel/talkgroup, by your dealer/programmer. When you edit a Scan list, you can either add, delete, or prioritize channels/talkgroups.

Note: Your radio cannot receive any calls while you are editing a Scan list.

ADD OR DELETE CHANNELS/ TALKGROUPS IN A SCAN LIST

1  or  to select a channel/talkgroup that contains a Scan list you want to edit.

2  to enter menu mode.

3  or  until 

4  to select 

5  or  until 

Note: One Scan list per channel/talkgroup is available.



6  to select 

7  or  until 



– or – until

8  to select the current setting.

9  or  until you see the channel/talkgroup you want to add or delete.

10  to confirm your selection.

11 If you added a channel/talkgroup,

you see: 
– or –

If you delete a channel/talkgroup,

you see: 

12  to confirm the deletion.

you see: 

13  to return to 

– or – 

14  until you exit menu mode.

PRIORITIZE A CHANNEL/ TALKGROUP IN A SCAN LIST

You may want to check the activity on one or two channels/talkgroups more frequently than others. You can do this by prioritizing them:

















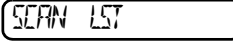

Priority Channel/ Talkgroup	Scanning Sequence
None specified	Ch1 → Ch2 → Ch3 → Ch4 → ... Ch1
Channel/ Talkgroup 2 (Priority 1)	Ch2 → Ch1 → Ch2 → Ch3 → Ch2 → Ch4 → Ch2 → ... Ch1
Channel/ Talkgroup 2 (Priority 1) and Channel/ Talkgroup 8 (Priority 2)	Ch2 → Ch1 → Ch8 → Ch3 → Ch2 → Ch4 → Ch8 → ... Ch1

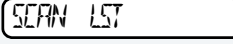
Note: If you are receiving on a non-priority channel/talkgroup and traffic becomes active on a priority channel/talkgroup, your radio will automatically switch to

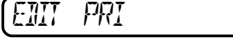

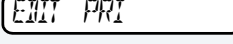
that priority channel/talkgroup and indicate the activity with a short tone.

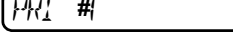
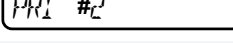
Set Priority Channels/Talkgroups

Note: You cannot have the same priority on two different channels/talkgroups.

- 1  to enter menu mode.
- 2  or  until 
- 3  to select 
- 4  or  until 
- 5  to select 
- 6  or  until 
- 7  to select 
- 8  or  until 
– or – until 
- 9  to select the desired priority level.

You see the current priority channel/talkgroup.

- 10  or  until you see the channel/talkgroup you want to prioritize.

– or – until
to select the current
channel/talkgroup the
radio is on.

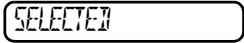
A rectangular screen capture showing the word "SELECTED" in a monospaced font.

– or – until
to de-prioritize the
current channel/talk-
group the radio is on.

A rectangular screen capture showing the word "DISABLED" in a monospaced font.

- 11  to prioritize that channel/talkgroup.

you see:

A rectangular screen capture showing the word "SAVED" in a monospaced font.

- 12  to return to

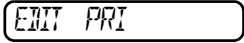
A rectangular screen capture showing the text "EDIT PRI" in a monospaced font.

- 13  until you exit menu mode.

Notes:

PHONE

Your radio allows you to place and receive telephone calls through a repeater (depending on phone line availability). You can edit the phone list through your radio's menu (see page 44).

The phone feature is available in both conventional and LTR systems.

-  appears on the display when you are in Phone mode.

Your dealer/programmer can preprogram your radio in one of three ways to enter your access/de-access code to the repeater.

Immediate Auto – your radio will transmit the access/deaccess code automatically upon entering phone mode or disconnecting a phone call. You will hear a series of tones, and see your access/deaccess code on the display, indicating that an access/deaccess code is being sent automatically.

Delayed Auto – your radio will transmit the access code upon a **PTT** button press. The de-access code is sent automatically when you exit phone mode.

Manual - Enter your access/deaccess code using the DTMF microphone keypad and press the **PTT** button.



RECEIVE A PHONE CALL

When a phone call is received, a ringing tone sounds, alerting you to answer the phone call.

Press the preprogrammed **Phone** button (see page 18), and skip to step 6.

– or –

Press the **PTT** button, and if the Hot Keypad feature has been preprogrammed by your dealer/programmer, do the following:



1  or  to select a channel/talkgroup that has been programmed for telephone.

2  to enter menu mode.

3  or  until 

4  to select 

Note: The  appears on the display.



- 5** Your dealer/programmer can preprogram your radio in one of three ways to enter your access code to the repeater.
- Immediate Auto** – automatically sends the access code.
- Delayed Auto** – your radio will transmit the access code upon a **PTT** button press.
- Manual** - Enter your access code using the DTMF microphone keypad and press the **PTT** button.
- 6** Hold the microphone 1 to 2 inches (2.5 to 5 cm) away from your mouth. Press and hold the **PTT** button to talk. Release the **PTT** button when the other party wants to talk, both parties will need to speak in turn.
- 7** To disconnect a phone call, do one of the following:
- If your radio has Immediate Auto or Delayed Auto programmed, go to step 8.
- or –
- Enter the deaccess code using the DTMF microphone keypad and press the **PTT** button.
- 8** To exit Phone Mode:
- Press the preprogrammed **Phone** button (see page 18).
- or –
- Press and hold  to disconnect the call.
- Note:**  disappears from the display.
-

MAKE A PHONE CALL ①

Press the preprogrammed **Phone** button (see page 18), and skip to step 6.

– or –

Press the **PTT** button, and if the Hot Keypad feature has been preprogrammed by your dealer/programmer, do the following:

1  or  to select a channel/talkgroup that has been programmed for telephone.

2  to enter menu mode.

3  or  until 

4  to select 

Note: The ① appears on the display.

5 Your dealer/programmer can preprogram your radio in one of three ways to enter your access code to the repeater.

Immediate Auto – automatically sends the access code.

Delayed Auto – your radio will transmit the access code upon a **PTT** button press.



Manual - Enter your access code using the DTMF microphone keypad and press the **PTT** button.

6 When you hear a dial tone:

Enter the phone number using the DTMF microphone keypad.

The number will scroll to the left,

– or –

 or  to select a number from the phone list.

Note: Only the first 8 digits are displayed.

– or –

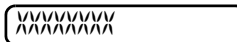
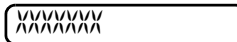

- a. Press and release the preprogrammed **Speed Dial** button.
- b. Press the key (0 to 9) corresponding to the number you want to call.

Note: To redial the last number dialed (if not using Speed Dial), press and release the **PTT** button immediately after the access code is sent. The radio sends the last number dialed.

– or –

If you entered your access code using the DTMF keypad, press  once to access the last number dialed; then press and release the **PTT** button.

7 Press and release the **PTT** button, if required for your radio.

8 Hold the microphone 1 to 2 inches (2.5 to 5 cm) away from your mouth. Press and hold the **PTT** button to talk. Release the **PTT** button when the other party wants to talk, both parties will need to speak in turn.

9 To disconnect a phone call, do one of the following:

If your radio has Immediate Auto or Delayed Auto programmed, go to step 10.

– or –

Enter the deaccess code using the DTMF microphone keypad and press the **PTT** button.

10 To exit Phone Mode:

Press the preprogrammed **Phone** button (see page 18).

– or –

Press and hold  to disconnect the call.













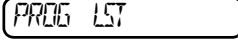

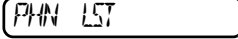

Note:  disappears from the display.

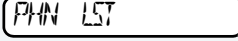
EDIT THE PHONE LIST



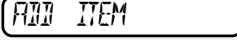





Your radio contains a Phone list that holds up to 25 phone numbers. You can edit the Phone list in three ways through your radio's menu:

- Add an entry
- Delete an entry
- Edit an existing entry

Add an Entry



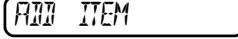





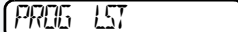





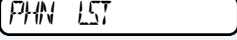



- 1  to enter menu mode.
- 2  or  until 
- 3  to select 
- 4  or  until 
- 5  to select 
- 6  or  until 
- 7  to select, 
you see: 
- 8 Use the DTMF microphone keypad to enter the name (see Entering Characters Using the DTMF Microphone Keypad on page 14).
- 9  to store the name,
you see: 

- 10 Use the DTMF microphone keypad to enter the phone number. You can also add a Pause Indicator by holding  until 'P' appears on the display.



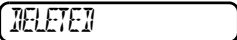









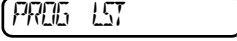

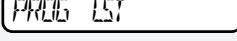

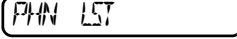
- 11  to store the phone number.
you see: 
- 12  or  until you see the location in the list where you want to store the phone number.
- 13  to store the location.
you see: 
- 14  to return to 
– or –
 until you exit menu mode.

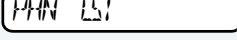

Delete an Entry





- 1  to enter menu mode.
- 2  or  until 
- 3  to select 



- 4  or  until 
- 5  to select 
- 6  or  until 
- 7  to select 
- 8  or  until you see the entry you want to delete.
- 9  to select the entry,
you see: 
- 10  again to confirm the deletion,
you see: 
- 11  to return to 
– or –
 until you exit menu mode.

Edit an Entry

- 1  to enter menu mode.
- 2  or  until 
- 3  to select 
- 4  or  until 
- 5  to select 
- 6  or  until 
- 7  to select 
- 8  or  until you see the entry you want to edit.
- 9  to select the entry.











- 10  or  until (to edit the name),
 – or – until (to edit the phone number),
 – or – until (to edit the location in the phone list).

- 11  to confirm your selection.
- 12 Use the DTMF microphone keypad to edit the entry (see Entering Characters Using the DTMF Microphone Keypad on page 14),
 – or –
 or  until you see the location where you want to store the phone number.
- 13  to store the information.
 you see:

- 14  to return to
 – or –
 until you exit menu mode.

Edit Access/Deaccess Codes

You can edit the access/de-access codes that are used to connect or disconnect you from a repeater.

- 1  to enter menu mode.
- 2  or  until
- 3  to select
- 4  or  until
- 5  to select
- 6  or  until
- 7  to select

8  or  until 



– or – until 

9  to select the current setting.

10 Enter the number using the DTMF keypad microphone.

11  to select the entry.











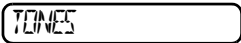

you see: 

12  or  to edit another code.

13  until you exit menu mode.

TONE PREFERENCES

You can use the radio's menu to access user-adjustable settings to customize the tones on your radio by:















- 1  to enter menu mode.
- 2  or  until 
- 3  to select 
- 4  or  until you see the feature you want to change (see the table on page 50).
- 5  to select the feature. You see the feature's current setting.
- 6  or  to see a list of available settings.
- 7  to select the desired setting.
- 8  until you exit the menu mode.

Tone Settings

Feature	What it Does	Settings
<i>TONE</i>	Turns all alert tones on or off.	<i>ON</i> <i>OFF</i>
<i>KPTD TONE</i>	Turns the keypad tones on or off.	<i>ON</i> <i>OFF</i>
<i>TONE TAG</i>	Assigns a specific tone when receiving a specific type of radio call.	<i>STANDARD</i> <i>ALERT 1-6</i>
<i>ESCALERT</i>	Increases the volume of the alarm tones when a radio call is not answered.	<i>ON</i> <i>OFF</i>

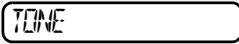

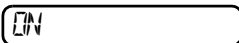

TONES ON/OFF













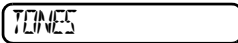

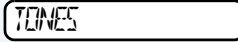
You can program your radio to enable or disable all alert tones.

- 1  to enter Menu mode.
- 2  or  until 
- 3  to select 
- 4  or  until 
- 5  to select 
- 6  or  until 

– or – until
- 7  to select the desired setting.

KEYPAD ON/OFF TONES

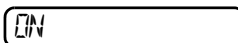
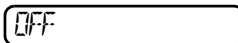
You can program your radio to enable or disable all keypad tones.













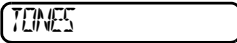

Note: Tones for the programmable buttons , , , and  can not be disabled.

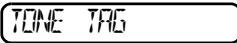

- 1  to enter Menu mode.
- 2  or  until 
- 3  to select 
- 4  or  until 
- 5  to select 
- 6  or  until 

– or – until
- 7  to select the desired setting.

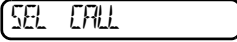
CALL TONE TAGGING (CONVENTIONAL OPERATION ONLY)

You can program your radio to sound a particular alert tone when receiving a Selective Call or Call Alert (call tone tagging).

Note: Seven alert tones are available to select from in the list.

- 1  to enter menu mode.
- 2  or  until 
- 3  to select 
- 4  or  until 
- 5  to select 
- 6  or  until 
- or – until 
- 7  to select the desired setting.

- 8  or  until you see and hear the tone you want to use for this type of call.

- 9  to select the desired setting,

you see:



- 10  to return to

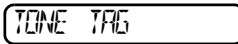















- 11  until you exit the menu mode.

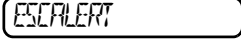

ESCALERT (CONVENTIONAL OPERATION ONLY)

You can program your radio to increase the volume of the alarm tones when a radio call is not answered.

Press the preprogrammed **Escalert** button (see page 18) and proceed to step 5.

– or –













- 1  to enter menu mode.
- 2  or  until 
- 3  to select 
- 4  or  until 
- 5  to select 
- 6  or  until 

– or – until 
- 7  to select the desired setting.

Notes:

USER SETTINGS

You can use the radio's menu to access user-adjustable settings to customize some of your radio features by:

- 1  to enter menu mode.
- 2  or  until 
- 3  to select 
- 4  or  until you see the feature you want to change (see the table on page 56).
- 5  to select the feature. You see the feature's current setting.
- 6  or  for available settings.
- 7  to select the desired setting.

Utilities Features











Feature	What it Does	Settings
SQUELCH	Changes the squelch of the radio to tight or normal.	TIGHT NORMAL
PWR LVL	Changes the power level of the radio to high or low.	HIGH LOW
OPT BRD	Enables or disables an option board.	ON OFF
BKLT INT	Changes the brightness of the backlight.	HIGH MED LOW
SOFTWARE	Displays the radio's software version number.	XX'XX'XX

SET SQUELCH LEVEL

Use this feature to filter out nuisance (unwanted) calls and/or background noise. However, tightening squelch could cause calls from remote locations to be filtered out as well. In this case, normal squelch may be more desirable.

Press the preprogrammed **Squelch** button (see page 18) to toggle between tight and normal squelch.

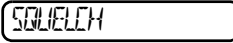
– or –

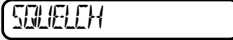
- 1  to enter menu mode.
- 2  or  until 
- 3  to select 
- 4  or  until 
- 5  to select 

- 6  or  until 
- or- until 

- 7  to select the current setting.

SET POWER LEVEL













Each channel/talkgroup in your radio has a predefined transmit power level that can be changed.

- *High power* (**H**) allows you to reach a radio that is farther away.
- *Low power* (**L**) to reach a radio within close proximity.

Note: The **L** or **H** symbol appears on the display when High/Low Power Level is selected.

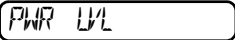
To set the power level, press the preprogrammed **Power Level** button (see page 18) to toggle between low and high power.

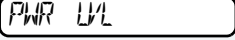
– or –

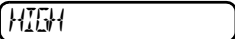
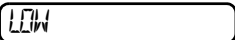
- 1  to enter menu mode.
- 2  or  until 
- 3  to select 
- 4  or  until 
- 5  to select 
- 6  or  until 

-or- until

- 7  to select the current setting.













OPTION BOARD ON/OFF

Use this feature to enable or disable an option board.

- The  symbol appears on the display when the option board feature is On.

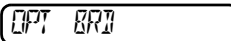
Press the preprogrammed **Option Board** button (see page 18) to toggle the option board on or off.

– or –

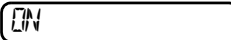
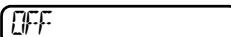











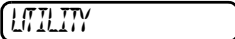

- 1  to enter menu mode.
- 2  or  until 
- 3  to select 
- 4  or  until 
- 5  to select 
- 6  or  until 

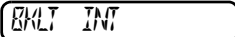
-or- until

- 7  to select the current setting.









SET THE BACKLIGHT INTENSITY

Use this feature to change the brightness of the backlight.

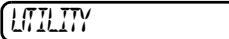
- 1  to enter menu mode.
- 2  or  until 
- 3  to select 
- 4  or  until 
- 5  to select 
- 6  or  until 
 -or- until 
 -or- until 
- 7  to select the current setting.

DISPLAY THE SOFTWARE VERSION

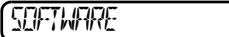
Use this feature to view the current software version of your radio.

- 1  to enter menu mode.
- 2  or  until 
- 3  to select 
- 4  or  until 
- 5  to view the software version.
- 6  until you exit menu mode.

Notes:

WARRANTY

LIMITED WARRANTY MOTOROLA COMMUNICATION PRODUCTS

I. WHAT THIS WARRANTY COVERS AND FOR HOW LONG:

MOTOROLA INC. (“MOTOROLA”) warrants the MOTOROLA manufactured Communication Products listed below (“Product”) against defects in material and workmanship under normal use and service for a period of time from the date of purchase as scheduled below:

PM400 Mobile Units	Two (2) Years
Product Accessories	One (1) Year

Motorola, at its option, will at no charge either repair the Product (with new or reconditioned parts), replace it (with a new or reconditioned Product), or refund the purchase price of the Product during the warranty period provided it is returned in accordance with the terms of this warranty. Replaced parts or boards are warranted for the balance of the original applicable warranty

period. All replaced parts of Product shall become the property of MOTOROLA.

This express limited warranty is extended by MOTOROLA to the original end user purchaser only and is not assignable or transferable to any other party. This is the complete warranty for the Product manufactured by MOTOROLA.

MOTOROLA assumes no obligations or liability for additions or modifications to this warranty unless made in writing and signed by an officer of MOTOROLA. Unless made in a separate agreement between MOTOROLA and the original end user purchaser, MOTOROLA does not warrant the installation, maintenance or service of the Product.

MOTOROLA cannot be responsible in any way for any ancillary equipment not furnished by MOTOROLA which is attached to or used in connection with the Product, or for operation of the Product with any ancillary equipment, and all such equipment is expressly excluded from this warranty. Because each system which may use the Product is unique, MOTOROLA disclaims liability for range, coverage, or operation of the system as a whole under this warranty.

II. GENERAL PROVISIONS:

This warranty sets forth the full extent of MOTOROLA'S responsibilities regarding the Product. Repair, replacement or refund of the purchase price, at MOTOROLA's option, is the exclusive remedy. THIS WARRANTY IS GIVEN IN LIEU OF ALL OTHER EXPRESS WARRANTIES. IMPLIED WARRANTIES, INCLUDING WITHOUT LIMITATION, IMPLIED WARRANTIES OF MERCHANTABILITY AND FITNESS FOR A PARTICULAR PURPOSE, ARE LIMITED TO THE DURATION OF THIS LIMITED WARRANTY. IN NO EVENT SHALL MOTOROLA BE LIABLE FOR DAMAGES IN EXCESS OF THE PURCHASE PRICE OF THE PRODUCT, FOR ANY LOSS OF USE, LOSS OF TIME, INCONVENIENCE, COMMERCIAL LOSS, LOST PROFITS OR SAVINGS OR OTHER INCIDENTAL, SPECIAL OR CONSEQUENTIAL DAMAGES ARISING OUT OF THE USE OR INABILITY TO USE SUCH PRODUCT, TO THE FULL EXTENT SUCH MAY BE DISCLAIMED BY LAW.

III. STATE LAW RIGHTS:

SOME STATES DO NOT ALLOW THE EXCLUSION OR LIMITATION OF INCIDENTAL

OR CONSEQUENTIAL DAMAGES OR LIMITATION ON HOW LONG AN IMPLIED WARRANTY LASTS, SO THE ABOVE LIMITATION OR EXCLUSIONS MAY NOT APPLY.

This warranty gives specific legal rights, and there may be other rights which may vary from state to state.

IV. HOW TO GET WARRANTY SERVICE:

You must provide proof of purchase (bearing the date of purchase and Product item serial number) in order to receive warranty service and, also, deliver or send the Product item, transportation and insurance prepaid, to an authorized warranty service location. Warranty service will be provided by Motorola through one of its authorized warranty service locations. If you first contact the company which sold you the Product (e.g., dealer or communication service provider), it can facilitate your obtaining warranty service. You can also call Motorola at 1-800-927-2744 US/Canada.

V. WHAT THIS WARRANTY DOES NOT COVER:

- A) Defects or damage resulting from use of the Product in other than its normal and customary manner.
- B) Defects or damage from misuse, accident, water, or neglect.
- C) Defects or damage from improper testing, operation, maintenance, installation, alteration, modification, or adjustment.
- D) Breakage or damage to antennas unless caused directly by defects in material workmanship.
- E) A Product subjected to unauthorized Product modifications, disassembles or repairs (including, without limitation, the addition to the Product of non-Motorola supplied equipment) which adversely affect performance of the Product or interfere with Motorola's normal warranty inspection and testing of the Product to verify any warranty claim.
- F) Product which has had the serial number removed or made illegible.
- G) Rechargeable batteries if:
 - 1) any of the seals on the battery enclosure of cells are broken or show evidence of tampering.
 - 2) the damage or defect is caused by charging or using the battery in equipment or service other than the Product for which it is specified.
- H) Freight costs to the repair depot.
- I) A Product which, due to illegal or unauthorized alteration of the software/firmware in the Product, does not function in accordance with MOTOROLA's published specifications or the FCC type acceptance labeling in effect for the Product at the time the Product was initially distributed from MOTOROLA.
- J) Scratches or other cosmetic damage to Product surfaces that does not affect the operation of the Product.
- K) Normal and customary wear and tear.

VI. PATENT AND SOFTWARE PROVISIONS:

MOTOROLA will defend, at its own expense, any suit brought against the end user purchaser to the extent that it is based on a claim that the Product or parts infringe a United States patent, and MOTOROLA will pay those costs and damages finally awarded against the end user purchaser in any such suit which are attributable to any such claim, but such defense and payments are conditioned on the following:

- A) that MOTOROLA will be notified promptly in writing by such purchaser of any notice of such claim;
- B) that MOTOROLA will have sole control of the defense of such suit and all negotiations for its settlement or compromise; and
- C) should the Product or parts become, or in MOTOROLA's opinion be likely to become, the subject of a claim of infringement of a United States patent, that such purchaser will permit MOTOROLA, at its option and expense, either to procure for such purchaser the right to continue using the Product or parts or to replace or modify the same so that it becomes non-infringing or to grant such purchaser a credit for the Product or parts as depreciated and accept its return. The depreciation will be an equal amount per year over the lifetime of the Product or parts as established by MOTOROLA.

MOTOROLA will have no liability with respect to any claim of patent infringement which is based upon the combination of the Product or parts furnished hereunder with software, apparatus or devices not furnished by MOTOROLA, nor will MOTOROLA have any liability for the use of ancillary equipment or software not furnished by MOTOROLA which is attached to or used in connection with the Product. The foregoing

states the entire liability of MOTOROLA with respect to infringement of patents by the Product or any parts thereof.

Laws in the United States and other countries preserve for MOTOROLA certain exclusive rights for copyrighted MOTOROLA software such as the exclusive rights to reproduce in copies and distribute copies of such Motorola software. MOTOROLA software may be used in only the Product in which the software was originally embodied and such software in such Product may not be replaced, copied, distributed, modified in any way, or used to produce any derivative thereof. No other use including, without limitation, alteration, modification, reproduction, distribution, or reverse engineering of such MOTOROLA software or exercise of rights in such MOTOROLA software is permitted. No license is granted by implication, estoppel or otherwise under MOTOROLA patent rights or copyrights.

VII. GOVERNING LAW:

This Warranty is governed by the laws of the State of Illinois, USA.

ACCESSORIES

Motorola offers a number of accessories to enhance the productivity of your two-way radio. Many of the available accessories are listed below.

ANTENNAS

HAD4006	VHF 136-144 MHz, 1/4 Wave Roof Mount
HAD4007	VHF 144-150.8 MHz, 1/4 Wave Roof Mount
HAD4008	VHF 150.8-162 MHz, 1/4 Wave Roof Mount
HAD4009	VHF 162-174 MHz, 1/4 Wave Roof Mount
RAD4000	VHF 136-174 MHz, 3 dB Gain (no mount)
HAD4014	VHF 140-174 MHz, 3.5 dB Gain Roof Mount
HAE4002	UHF 403-430 MHz, 1/4 Wave Roof Mount
HAE4003	UHF 450-470 MHz, 1/4 Wave Roof Mount
HAE4004	UHF 470-512 MHz, 1/4 Wave Roof Mount

HAE4010	UHF 406-420 MHz, 3.5 dB Gain Roof Mount
HAE4011	UHF 450-470 MHz, 3.5 dB Gain Roof Mount
RAE4004_RB	UHF 445-470 MHz, 5 dB Gain Roof Mount
RAE4004_MB	UHF 445-470 MHz, 5 dB Gain Magnetic Mount
TAE6053	UHF 430-450 MHz, 1/4 Wave Roof Mount

ALARM AND ACCESSORIES

RLN4856	Footswitch with Remote PTT
RLN4857	Pushbutton with Remote PTT
RLN4858	Gooseneck PTT
RLN4836	External PTT with Emergency Footswitch
HLN9328	External Alarm Relay (used in conjunction with GLN7282)
GLN7282	Buzzer Kit (used in conjunction with HLN9328)

AUDIO

HMN3596	Standard Microphone
HMN1035	Heavy Duty Microphone

RMN5029	Enhanced Keypad Microphone
RMN5018	Mag One Microphone (Low Cost) (6 months warranty only)
RMN5019	Mag One Keypad Microphone (Low Cost) (6 months warranty only)
AAREX4617	Telephone Style Handset Kit
GMMN4065	Visor Microphone (Omni-Direction)
AARMN4027	Visor Microphone - High Noise (Uni-Direction)
RSN4001	External Speaker 13 W
HSN8145	External Speaker 7.5 W
HLN9073	Microphone Hang-up Clip (requires install)
HLN9414	Microphone Hang-up Clip (Univer- sal - no install required)

CABLES

HKN9327	Ignition Switch Cable
HKN4137	Low Power Cable to Battery (1-25 W)
HKN4191	High Power Cable to Battery (25-60 W)

CONTROL STATION

HPN4002	Desktop Power Supply 1-25 W
HPN4001	Desktop Power Supply 25-60 W
HMN3000	Black Desk Microphone
RLN5390	Desktop Tray with Speaker
RLN5391	Desktop Tray without Speaker

DATA - CES WIRELESS TECHNOLOGIES

RDN7364	Base Modem
RDN7367	Mobile Display Terminal with GPS
RDN7368	Mobile Display Terminal
RDN7369	Stand Alone Modem with GPS
RDN7370	Interface Cable, 3 ft
RDN7376	Interface Cable, 15 ft
RDN7372	Fixed Mount GPS Active Antenna
RDN7373	Mobile Printer
RDN7374	Programming Software for CES Equipment
RDN7380	Mobile Programming Hardware
RDN7375	Magnetic Mount GPS Antenna
RDN7377	MAPS (US) Regional
RDN7378	AVL Messaging Statue Software

RDN7371	Credit Card Reader
RDN7738	Serial Breakout Unit (multiple modems)
RDN7739	Flying Lead Cable, 3 ft.
RDN7740	Flying Lead Cable, 15 ft.

MOUNTING



GLN7324	Low Profile Mounting Bracket
GLN7317	High Profile Mounting Bracket
FTN6083	DIN Mount
HLN8097	Removable Slide Mount with Mini-U Connector
HLN9227	8 in. Gooseneck Trunnion
RLN4779	Keylock Mounting Bracket

PUBLIC ADDRESS

RLN5288	Public Address Kit (includes switch box and cabling)
HKN9324_R	Speaker Cable for PA (15 ft)
HSN1000	External Speaker, 6 W for public address

Notes:

Restore Channels/Talkgroups to the Scan List

Power off the radio then turn it on. – OR – Press the preprogrammed **Scan** button to stop the scan. The Deleted Nuisance channels/talkgroups are restored to the scan list. – OR –  or  to select a channel/talkgroup that has **not** been preprogrammed by your dealer/programmer. Once you return to the original channel/talkgroup, the deleted nuisance channels/talkgroups are restored to the scan list.

Send a Selective Call

1. From the Selective Call menu, select or enter desired radio ID number.
2. Press PTT button to send the call.
3. Press and hold the PTT button to speak; release to listen.

Receive a Selective Call

1. When a Selective Call is received, the radio displays  and the name or ID of the calling radio; the yellow LED flashes and two tones are heard.
2. Press PTT button to acknowledge the call.
3. Press and hold the PTT button to speak; release to listen.

LED Indicators

LED State/Color	Indication
Radio Call	
Red	Transmitting
Flashing Red	Receiving
Flashing Red	Channel Busy
Scan	
Flashing Green	Scanning for activity
Call Alert	
Flashing Yellow	Indicates receiving a Call Alert
Yellow	Indicates sending a Call Alert
Selective Call	
Flashing Yellow	Indicates receiving a Selective Call
Yellow	Indicates sending a Selective Call
Sticky Monitor/Open Squelch	
Yellow	While monitoring

Audio Indicators for Programmable Buttons

Programmable Buttons	Positive Indicator Tone	Negative Indicator Tone
Scan	Start	Stop
Power Level	High	Low
Squelch	Tight	Normal
Repeater/Talkaround	Does not use repeater	Uses repeater
VOX	Enabled	Disabled
Local/Distance	Local	Distance
Sticky Monitor/Open Squelch	–	Enabled
Home Revert Memory Channel (1&2)	–	Enabled
Store Memory Channel (1&2)	–	Stored
Home Revert AutoKey (1&2)	–	Enabled
Menu Mode 	–	Accessed
Radio Call	–	Enabled
Scan List Edit	–	Enabled
Speed Dial	–	Enabled
Phone Mode	–	Enabled
Option Board	Enabled	Disabled
Escalert	Enabled	Disabled

Menu Navigation Chart

(Refer to Menu Navigation guidelines—
lower, left-hand corner of this page)

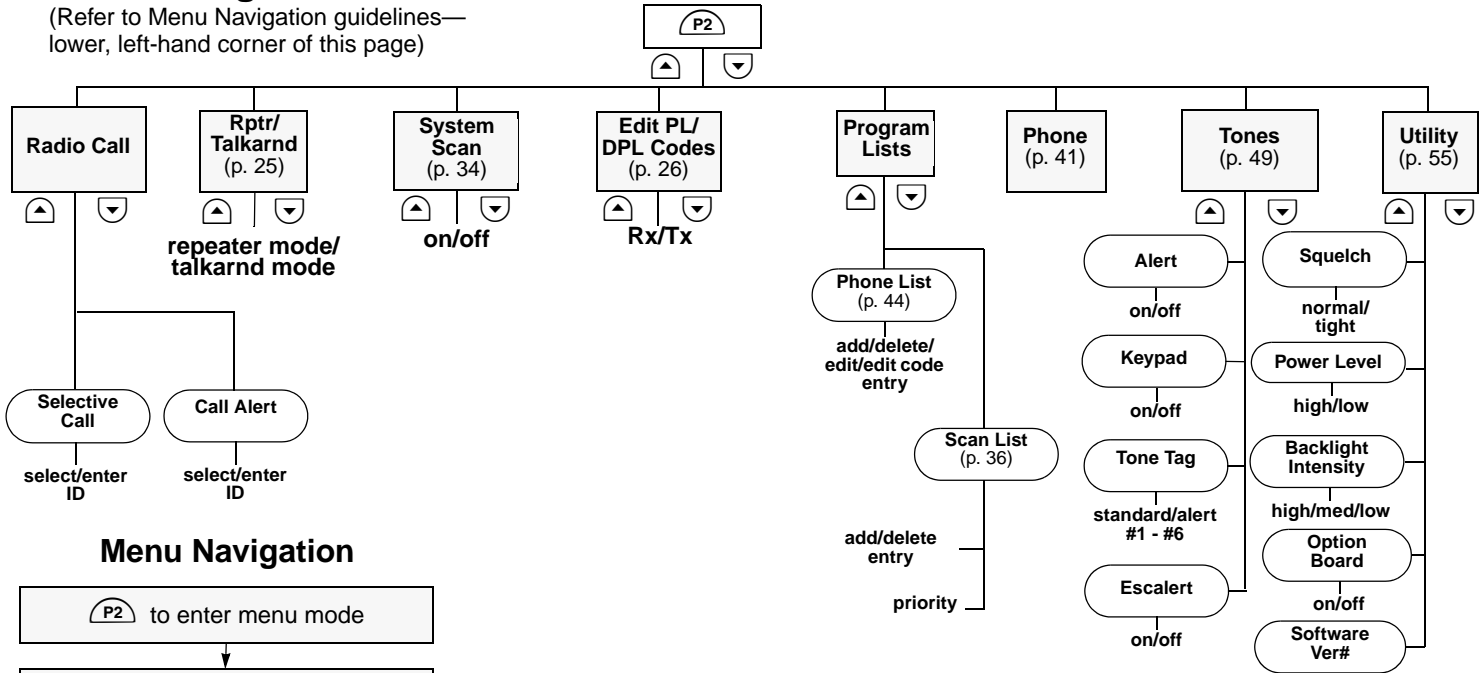

Menu Navigation

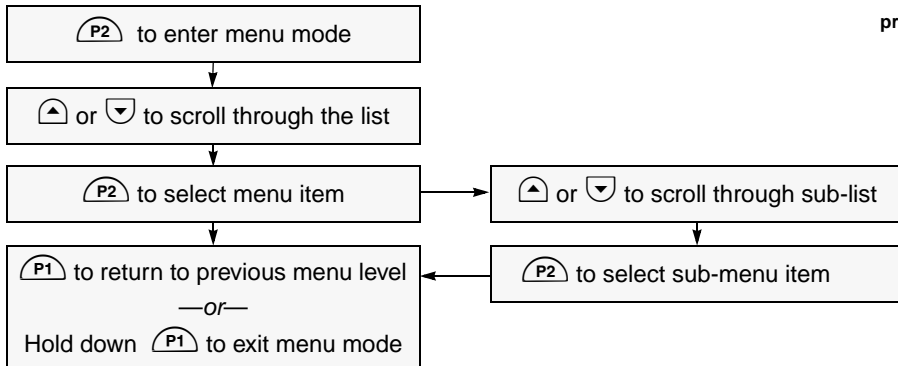



MOTOROLA and the Stylized M Logo are registered in the US Patent & Trademark Office.
All other product or service names are the property of their respective owners.
© Motorola, Inc. 2004. All rights reserved. Printed in U.S.A.

MOTOROLA et le logotype au M stylisé sont enregistrés auprès du Bureau des marques et brevets des États-Unis.
Tous les autres noms de produits et de services sont la propriété de leurs titulaires respectifs.
© Motorola, Inc. 2004. Tous droits réservés. Imprimé aux États-Unis.



6881096C32-B