



**Professional Series
Two-Way Radio User Guide**

**Séries professionnelles
Guide de l'utilisateur de radio bidirectionnelle**

HT1550•XLS

CONTENTS

Computer Software Copyrights	4	Battery Charge Status	20
Safety	5	Attaching the Battery	21
Product Safety and RF Exposure		Removing the Battery	21
Compliance	5	Accessory Information	22
Radio Overview	7	Attaching the Antenna	22
Parts of the Radio		Removing the Antenna	22
HT1550•XLS™ Model	7	Attaching the Belt Clip	23
On/Off/Volume Knob	8	Removing the Belt Clip	23
Channel or Zone/Menu Selector Knob	8	Attaching the Side Connector Cover	24
LED Indicator	8	Turning the Radio On or Off	24
Side Connector	8	Entering Your Password	25
Programmable Buttons	8	Adjusting the Volume	25
Push-to-Talk (PTT) Button	13	Selecting a Conventional or Trunked	
Microphone	13	Zone	25
Menu Keys	13	Selecting a Channel or Talkgroup	26
Keypad Keys	14	Sending a Conventional Call	27
LCD Screen	16	Sending a Trunked Call	27
Audio Indicators for Programmable		Receiving a Trunked or Conventional	
Buttons	18	Call	28
Getting Started	19	Radio Calls	29
Battery Information	19	Making a Selective Call	29
Charging the Battery	19	Receiving a Selective Call	30
		Sending a Call Alert Page	30
		Receiving a Call Alert Page	31
		Radio Check	31
		Sending a Status	32

Sending a Message	33	Deleting a Nuisance Channel/Talkgroup (System Scan Operation Only)	50
Receiving a Message	34	Restoring a Channel/Talkgroup Back to the Scan List	50
Sending an Emergency Alert	34	Editing a Scan List (System Scan Operation Only)	50
Call Stacking	35	Adding or Deleting Channels or Talkgroups in a Scan List	51
Editing a Radio Call List	36	Prioritizing a Channel/Talkgroup in a Scan List	52
Repeater or Talkaround Mode (Conventional Operation Only)	37	Setting Priority Channels or Talkgroups	52
Setting Tight or Normal Squelch	37	Phone	55
Setting the Power Level	38	Making a Phone Call Through an LTR System	55
Name and Call Alert Tone Tagging	39	Making a Phone Call Through a Conventional System	56
Special Calls	41	Receiving a Phone Call Through an LTR or Conventional System	58
Status Calls	41	Modifying the Phone List	59
Making a Status Call	41	Voice Storage	63
Receiving a Status Call	43	Incoming Call Recording	64
Emergency Calls	43	Selective Incoming Call Recording	64
Priority Calls	44	All Incoming Call Recording	64
Broadcast Calls	44	To Record All Incoming Calls:	65
DTMF	45	Voice Memo Recording	66
Scan	47		
Talkback	47		
Auto Group Scan (LTR Trunked Operation Only)	47		
All Group Scan (LTR Trunked Operation Only)	48		
System Scan (LTR and Conventional Operation)	49		

Recorded Message Playback	67	Headsets	87
Recorded Message Delete	68	CommPort™ Integrated Microphone	
Recorded Message Transmission.	69	Receiver System	87
Automatic Message Reply:		Surveillance Kits	88
“When Available”	70	Earpieces	89
Audio/Tone Settings	73	Ear Microphone System (EMS).	89
Utilities	75	Radio Interface Modules for Ear	
Setting the Clock	78	Switches	89
Home Channel Revert.	79	Adapters	89
Home Revert Autokey			
(LTR Operation Only)	79		
Warranty	81		
Limited Warranty	81		
Accessories	85		
Antennas	85		
Batteries	85		
Carry Accessories	85		
Carry Cases	85		
Belt Clips	86		
T-Straps	86		
Belt-Loops	86		
Chargers	86		
Audio Accessories.	86		
Microphones	86		

COMPUTER SOFTWARE COPYRIGHTS

The Motorola products described in this manual may include copyrighted Motorola computer programs stored in semiconductor memories or other media. Laws in the United States and other countries preserve for Motorola certain exclusive rights for copyrighted computer programs, including, but not limited to, the exclusive right to copy or reproduce in any form the copyrighted computer program. Accordingly, any copyrighted Motorola computer programs contained in the Motorola products described in this manual may not be copied, reproduced, modified, reverse-engineered, or distributed in any manner without the express written permission of Motorola. Furthermore, the purchase of Motorola products shall not be deemed to grant either directly or by implication, estoppel, or otherwise, any license under the copyrights, patents or patent applications of Motorola, except for the normal non-exclusive license to use that arises by operation of law in the sale of a product.

SAFETY

PRODUCT SAFETY AND RF EXPOSURE COMPLIANCE



Before using this product, read the operating instructions for safe usage contained in the Product Safety and RF Exposure booklet enclosed with your radio.

ATTENTION!

This radio is restricted to occupational use only to satisfy FCC RF energy exposure requirements. Before using this product, read the RF energy awareness information and operating instructions in the Product Safety and RF Exposure booklet enclosed with your radio (Motorola Publication part number 68P81095C98) to ensure compliance with RF energy exposure limits.

For a list of Motorola-approved antennas, batteries, and other accessories, visit the following web site which lists approved accessories: <http://www.motorola.com/cgiss/index.shtml>.

Notes

RADIO OVERVIEW

PARTS OF THE RADIO

HT1550•XLS™ Model

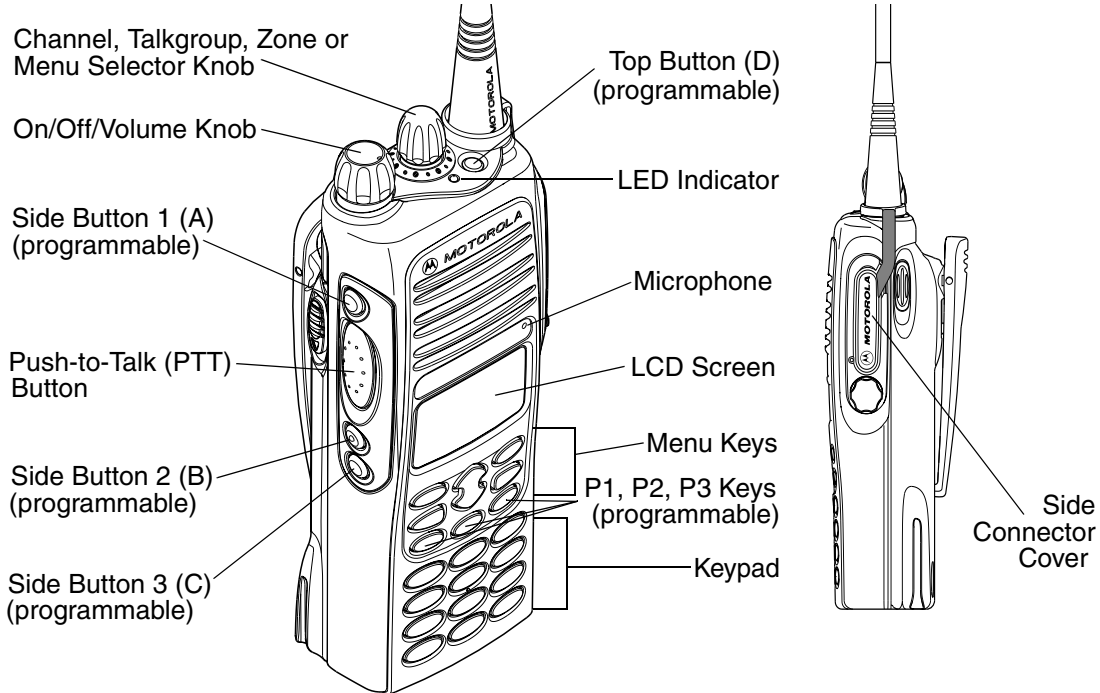

On/Off/Volume Knob

Turns the radio on or off, and adjusts the radio's volume.

Channel or Zone/Menu Selector Knob

Switches the radio to different conventional or trunked zones. Also, can be used for scrolling between conventional channels or trunked talkgroups.

LED Indicator

Indicates status of battery, power-up, scan, and receipt of a channel, talkgroup, or a selective call (see table below):

LED Color	Indicates
Steady red	Radio is transmitting (PTT button pressed)
Flashing red	Radio is attempting to access trunked system (PTT button pressed), or Radio is receiving (PTT button released)
Single flashing yellow	Call Light feature

LED Color	Indicates
Double flashing yellow	Selective call received (LTR only)
Momentary green	Radio has powered-up successfully
Single flashing green	System or All Group Scan operation, PassPort Group Scan

Side Connector

Used for connecting accessories, such as headsets and remote speaker/microphones, to the radio.

Replace the attached side connector cover when the connector is not in use.

Programmable Buttons

Several of your radio's buttons can be programmed by your dealer as shortcut buttons for many of the radio's features.

Programmable buttons include:

- The three Side Buttons (A, B, C) and the Top Button (D)
- The three lower Menu Keys (P1, P2, P3) (when the radio is not in menu mode)

Each button can be programmed to select up to two features, depending on the type of button press:

- **Short press**—quickly pressing and releasing the programmable buttons,

or

- **Long press**—pressing and holding the programmable buttons for a period of time (at least 1 1/2 seconds),

or

- **Hold down**—pressing and holding down the programmable buttons while checking status or making adjustments.

The tables on pages 18 through 20 summarize the programmable features available and shows the page number describing the feature. In the “Button” column, have your dealer write down the programmable buttons next to the features that have been programmed to them. Use the abbreviations (for example, A for Side Button 1, D for Top Button, etc.) shown in the radio illustration at the front of this manual.

Also, where a choice exists, have your dealer indicate whether the button press is short press (SP) or long press (LP).

Check with your dealer for a complete list of features your radio supports.

Programmable Features

Feature	Indicator	Short Press	Long Press	Hold Down	Page	Button
Battery Gauge	LED Color	—	—	Check the battery's charge status.	20	
Emergency Alert (Top button only)	△	Initiate Emergency Alert.	Cancel Emergency Alert.	—	34	
Home Channel Revert	—	Directly access your favorite trunked zone and talkgroup or conventional channel.†		—	79	
Home Revert AutoKey	—	Automatically keys up the radio, directly access your favorite trunked talkgroup and send a PTT-ID. ‡		—	—	
Keypad Lock	⊘	—	Toggle keypad between locked and unlocked.	—	—	
Light	—	Turn on your radio backlight.†		—	—	
Monitor §	▷	Exit permanent monitor mode.	Enter permanent monitor mode.	Continually monitor channel.	—	
Phone	①	Directly access Phone mode.†		—	55	

† This feature is activated by **EITHER** a short **OR** a long press, but not both.

§ Conventional operation only. ‡LTR trunked operation only.

Programmable Features (Continued)

Feature	Indicator	Short Press	Long Press	Hold Down	Page	Button
Power Level	LH	Toggle transmit power level between high and low.†		—	38	
Radio Call ‡	LED Color	Directly access radio call menu.†		—	29	
Repeater/ Talkaround §	→	Toggle between using a conventional repeater or transmitting directly to another radio.†		—	37	
Scan/Delete Nuisance Channel	Z	Turn PassPort Group, All Group, and System scan on or off.	Delete a nuisance channel while scanning.	—	48	
Speed Dial	—	Quickly access speed dial phone list.†		—	55	
Squelch §	—	Toggle squelch level between tight and normal.†		—	37	
Voice Storage Record/Play- back	—	Playback recorded messages.	Record voice memos.	—	66,67	
Voice Storage Playback Exit	—	Exit Voice Storage Play Back mode.†		—	67	

† This feature is activated by **EITHER** a short **OR** a long press, but not both.

§ Conventional operation only. ‡LTR trunked operation only.

Programmable Features (Continued)

Feature	Indicator	Short Press	Long Press	Hold Down	Page	Button
Voice Storage Playback Delete	—	Delete recorded messages.†		—	68	
Volume Set	—	—	—	Sound a tone for adjusting your radio's volume level.	25	
Edit Scan List	—	Add, Delete, or prioritize talkgroups or channels.			50	

† This feature is activated by **EITHER** a short **OR** a long press, but not both.

§ Conventional operation only. ‡ LTR trunked operation only.

Push-to-Talk (PTT) Button

Press and hold down this button to talk; release it to listen.

Microphone

When sending a message, hold the microphone 1 to 2 inches (2.5 to 5 cm) away from your mouth, and speak clearly into the microphone.

Menu Keys

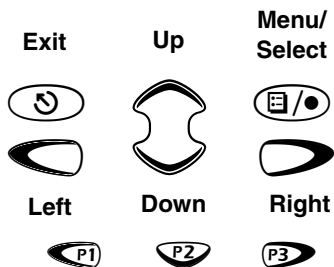

Menu/Select Key

Used to enter Menu Mode. When in Menu Mode, this key is also used to make menu selections.

Exit Key

Used to move to the previous Menu level (short press) or to exit Menu Mode (long press).

Up/Down Key

Depending on how your radio is programmed, it is used to:

- Scroll through the programmed talkgroups or a selected trunked zone, or through conventional channels.
- Scroll through conventional or trunked zones.
- Scroll when in menu mode.

Right Key

Moves the cursor right or inserts a space when editing.

Left Key

Used as a backspace key when editing.

Keypad Keys

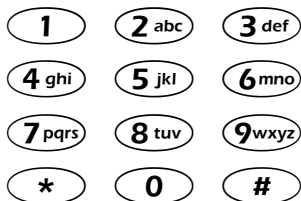

These keys are used for:

- Dialing a phone number
- Making a radio call
- Entering information when programming radio call, scan, and phone lists.

Each key can generate several different characters. For example, to enter the character “C,” press the (2 abc) key three times. (Refer to the following table.)

.





Entering Characters Using the Keypad



Key	Number of Times Key is Pressed														
	1	2	3	4	5	6	7	8	9	10	11	12	13	14	15
0	0	()	<	>										
1	1	&	%	#	*										
2 abc	A	B	C	2	a	b	c	2	Á	Ç	à	á	ç		
3 def	D	E	F	3	d	e	f	3	È	É	Ê	è	é	ê	
4 ghi	G	H	I	4	g	h	i	4	Í	ì	í				
5 jkl	J	K	L	5	j	k	l	5							
6 mno	M	N	O	6	m	n	o	6	Ñ	Ó	Ô	ò	ó	ô	ö
7 pqrs	P	Q	R	S	7	p	q	r	s	7					
8 tuv	T	U	V	8	t	u	v	8	Ú	ù	ú				
9 wxyz	W	X	Y	Z	9	w	x	y	z	9	Y	y			
*	*	/	+	-	=										
#	#	Blank Space	-	.	!	?	'	”	,	;	:				







LCD Screen





The top two screen rows show menu and radio status information.

Symbol	Indication
 X-Pand™	The X-Pand feature is activated. When in narrow band, this feature improves audio quality.
 Power Level	Low Power “L” or High Power “H” is activated.
 Monitor	The selected channel is being monitored (conventional operation only).
 Phone	Phone Mode is selected.
 Emergency	An Emergency Alert is being sent.

Symbol	Indication
 Scan	<p>When the green LED is blinking, indicates that the System or All Group Scan or Conventional Scan feature has been activated.</p> <p>When the green LED is off, indicates that non-prioritized Auto Group Scan has been activated.</p>
 Priority 1 Scan (• flashing)	<p>During Scan, indicates that there is some activity on a <i>Priority 1</i> channel or talkgroup during System Scan.</p>
 Priority 2 Scan (• steady)	<ul style="list-style-type: none"> • When the green LED is on, indicates activity on a priority 2 talkgroup or channel during System Scan. • When the green LED is off, indicates prioritized Auto Group Scan has been activated.

Symbol	Indication
 Programming Mode	<p>A Program List is being edited.</p>
 Keypad Lock	<p>The keypad is locked.</p>
 Signal Strength	<p>The more bars, the stronger the signal being received.</p>
 Option Board	<p>Option board is activated. This icon applies to future options.</p>
 Call Received	<p>A Selective Call, Call Alert or Message Alert has been received.</p>
 Call Stack	<p>Shows that you received calls while you were unavailable. This symbol flashes when the call stack is full.</p>

Symbol	Indication
 Talkaround	You are not transmitting through a repeater (conventional operation only).
 Battery Level	The number of bars (0 - 4) shown indicates the charge remaining in your battery.

AUDIO INDICATORS FOR PROGRAMMABLE BUTTONS



High-Low Tone



Low-High Tone

In addition to having visual indicators, some programmable buttons use tones to indicate one of two modes:

Button	Low-High Tone	High-Low Tone
Scan	Start Scan	Stop Scan
Power Level	Low power selected	High power selected
Squelch (no visual indicator)	Tight squelch	Normal squelch
Option Board	Activated	Deactivated
Keypad Lock	Locked	Unlocked
Repeater/ Talkaround	Does not use conventional repeater	Uses conventional repeater

GETTING STARTED

BATTERY INFORMATION

Charging the Battery

If a battery is new or its charge level is very low, you need to charge it before you can use it.

Note: Batteries are shipped uncharged from the factory. Always charge a new battery 14 to 16 hours before initial use, regardless of the status indicated by the charger.

To charge the battery:

Place the battery, with or without the radio, in the charger. The charger LED indicates the charging progress:

LED Color	Battery/Charger Status
No LED Indication	Battery inserted incorrectly.
Single Green Flash	Successful charger power-up.
Flashing Red*	Battery unchargeable or not making proper contact.
Steady Red	Battery in rapid-charge mode.
Flashing Yellow	Battery in charger, not in rapid-charge mode but waiting to be charged.
Flashing Green†	Battery 90% (or more) charged.
Steady Green	Battery fully charged.







* Remove the battery from the charger. Clean battery contacts with isopropyl alcohol applied to a soft cloth. Place the battery back in the charger. If the LED indicator continues to flash red, replace the battery.

† A standard battery may require one hour to charge to 90%.

Battery Charge Status

You can check your battery's charge status in two ways:

- The charge status is shown by the  status indicator symbol on the LCD screen. This does not require any action by you; the symbol is shown automatically.
- Hold down the preprogrammed **Battery LED Indicator** button (see page 18). The charge status is shown by the color of the radio's LED indicator.

Battery Level	LED Indicator	Status Indicator 
High	Green	
Sufficient	Yellow	 or 
Low	Flashing red	
Very Low	None	 (flashing)

Battery chargers will only charge the Motorola-authorized batteries listed below; other batteries may not charge.

Part No.	Description
HNN9008	1500 mAH NiMH High Capacity Battery (standard)
HNN9009	1900 mAH NiMH Ultra High Capacity Battery
HNN9010	1800 mAH NiMH, Ultra High Capacity - Factory Mutual
HNN9011	1200 mAH Ni-Cad, High Capacity Battery - Factory Mutual
HNN9012	1300 mAH Ni-Cad High Capacity Battery
HNN9013	1200 mAH Lithium Ion Battery

Attaching the Battery

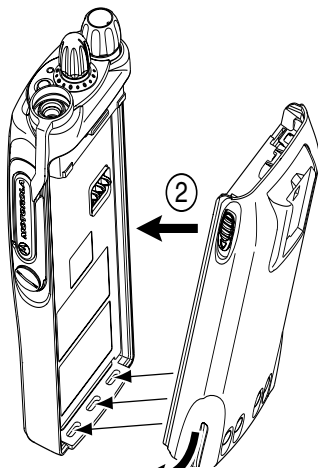

- 1 Fit the extensions at the bottom of the battery into the bottom slots on the radio.
- 2 Press the top part of the battery toward the radio until you hear a double click.

Removing the Battery

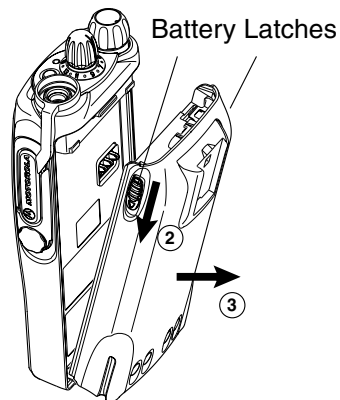

- 1 Turn off the radio (see page 20).
- 2 Slide both battery latches downward.
- 3 Pull the top part of the battery away from the radio.

ACCESSORY INFORMATION

Attaching the Antenna

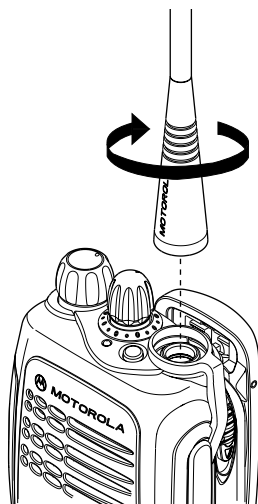

- 1 Turn the antenna clockwise to attach it.

Removing the Antenna

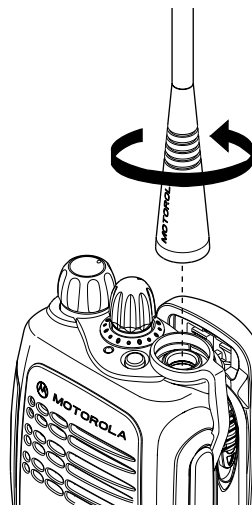

- 1 Turn the antenna counterclockwise to remove it.

Attaching the Belt Clip

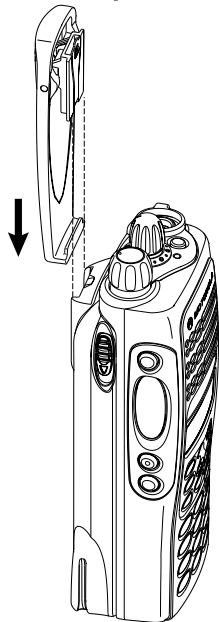

- 1 Align the grooves of the belt clip with those of the battery.
- 2 Press the belt clip downward until you hear a click.

Removing the Belt Clip

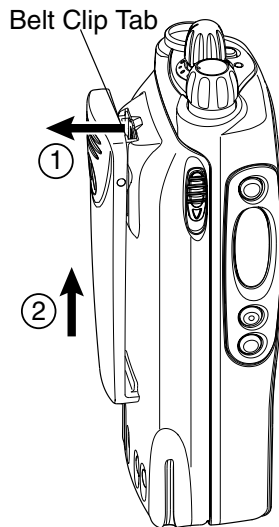

- 1 Use a key to press the belt clip tab away from the battery.
- 2 Slide the belt clip upward to remove it.

Attaching the Side Connector Cover

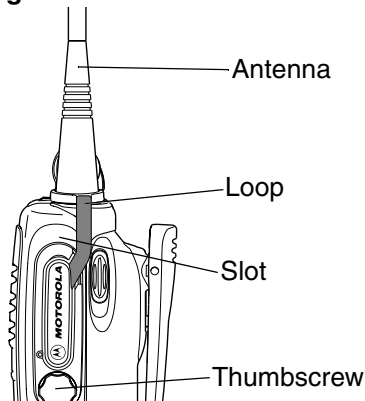

- 1 Place the loop (attached to the side connector cover) over the antenna; then slide it downward until it touches the top of the radio.
- 2 Insert the tab on the top of the cover into the slot above the connector.
- 3 Position the cover over the connector and align the thumbscrew with the threaded hole in the radio.
- 4 Tighten the thumbscrew to hold the cover in place. **Do not overtighten the thumbscrew.**

TURNING THE RADIO ON OR OFF

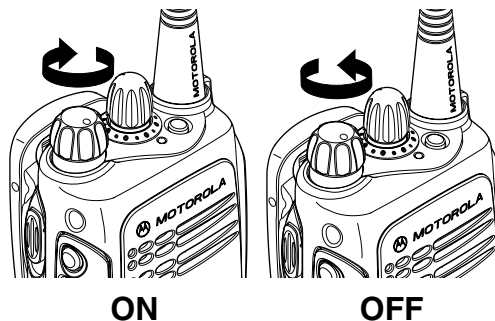

Turn the **On/Off/Volume** knob clockwise.
If power-up is successful, you hear the Self-Test Pass Tone



and see the LED momentarily turn green.



If the radio fails to power up, you hear the Self-Test Fail Tone .

Turn the **On/Off/Volume Control** knob counterclockwise until you hear a click.

ENTERING YOUR PASSWORD

If Radio Lock is programmed by your dealer, you are prompted to enter a four-digit password to gain access to your radio. The initial password is 0000.

To enter your password:

- 1 Enter the four-digit password using the numeric keypad.
- 2  to correct mistakes
- 3  to process password.

ADJUSTING THE VOLUME

Turn the **On-Off/Volume Control** knob clockwise to increase the volume or counterclockwise to decrease the volume.

—or—

- 1 Hold down the **Volume Set** button; you hear a continuous tone.
- 2 Turn the **On-Off/Volume Control** knob to the desired volume level.
- 3 Release the **Volume Set** button.

SELECTING A CONVENTIONAL OR TRUNKED ZONE

Up to 15 trunked zones (containing 16 talkgroups each) and 16 conventional zones can be programmed into your radio.

To select a zone:

Note: The selection of zones can be programmed by your dealer either on the Selector knob or via the Menu.

Use the Zone/Channel/Menu Selector knob to select the appropriate Zone.

—or—

1  to enter Menu Mode.

2  until

Zone

3  to select

Zone

4  until you see the desired zone.

5  to select the desired zone.

SELECTING A CHANNEL OR TALKGROUP

Your radio offers up to 160 channels (10 zones of 16 channels each) and up to 15 LTR zones with 16 talkgroups each.

Note: Due to government regulations, some channels may not be programmed. Ask your dealer for more information.

To select a channel or talkgroup:

1 Select the appropriate zone, if required (“Selecting a conventional or trunked zone” see page 25).

2 Depending how it was programmed by your dealer, turn the Channel/Talkgroup/Zone or Menu Selector knob clockwise or counterclockwise until you reach the desired channel/talkgroup.

—or—

1  to enter Menu Mode.

2  until

CHANNEL/TKGP

3  to select

CHANNEL/TKGP

4  until you see the desired channel/tkgrp.

5  to select the desired channel/tkgrp.

SENDING A CONVENTIONAL CALL

Note: In the United States, FCC regulations require you to monitor the conventional channels before sending a call. The monitor feature (see page 10) can be accessed through one of your programmable buttons.

1 Turn your radio on.

2 Select the desired channel (see page 26 “Selecting a Channel/Talkgroup”).

3 Hold the radio in a vertical position at a distance of about 1 to 2 inches (2.5 to 5 cm) from your mouth.



4 Press the **PTT** button and speak clearly into the microphone. The LED indicator lights steady red while the call is being sent.

5 Release the **PTT** button to listen.

SENDING A TRUNKED CALL

1 Turn your radio on.

2 Select the desired zone and talkgroup (see page 26 “Selecting a Channel/Talkgroup”).

3 Hold the radio in a vertical position at a distance of about 1 to 2 inches (2.5 to 5 cm) from your mouth.



- 4 Press and hold the **PTT** button.
–or–
Press and release the **PTT** button and wait 3 seconds.
 - If access to the trunked system was successful, the LED indicator lights steady red.
 - In addition, your dealer can program your radio to sound a short, high-pitched (talk permit) tone, indicating successful trunked system access.
 - If access to the trunked system was unsuccessful, the LED indicator flashes red and a low-pitched (talk prohibit) tone sounds, indicating that the system was busy or out-of-range.

- 5 With the **PTT** button depressed, speak clearly into the microphone.

- 6 Release the **PTT** button to listen.

RECEIVING A TRUNKED OR CONVENTIONAL CALL

- 1 Turn your radio on.
 - 2 Adjust your radio's volume (see page 25).
 - 3 Select the desired trunked or conventional zone (see page 25 "Selecting a Zone").
 - Make sure the **PTT** button is released.
 - 4 Listen for voice activity. The LED indicator flashes red when your radio is receiving.
-

RADIO CALLS









MAKING A SELECTIVE CALL

You can make a selective call to a particular radio or group of radios, as programmed by your dealer, using MDC or Quik Call II encode signaling, provided the receiving radio has the associated decode capability. DTMF encode signaling is supported; DTMF decode requires an additional board assembly in your radio.

To make a Selective Call:

Press the preprogrammed Radio Call button (see page 11) and proceed to step 4

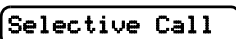
—or—

- 1  to enter Menu Mode.
- 2  until 
- 3  to select 
- 4  until 
- 5  to select 

- 6  to locate the desired ID in the Radio Call List.

—or—

Enter the ID number of the radio you want to call.

- 7 Press the **PTT** button to send the call.

The radio sounds a continuous tone, if programmed by your dealer.

- 8 Press the **PTT** button and talk; release the **PTT** button to listen.

- 9  To return to



—or—

Hold down  to exit Menu Mode.

RECEIVING A SELECTIVE CALL

When you receive a selective call:

- The LCD screen displays  and the preprogrammed name or ID of the calling radio.
- The LED indicator flashes yellow, if programmed by your dealer.
- You hear an alert tone.

To answer the call, press the **PTT** button.

Note: Unless you make a Selective Call back to the caller, your response is heard by all members of your talkgroup.

SENDING A CALL ALERT PAGE

You can alert another person by sending a Call Alert page.

To send a Call Alert page:

Press the preprogrammed Radio Call button (see page 11) and proceed to step 4

–or–

1  to enter Menu Mode.

2  until

Radio Call

3  to select

Radio Call

4  until

Call Alert

5  to select

Call Alert

6  to locate the desired ID in the Radio Call List.

–or–

Enter the ID number of the radio you want to page.

7 Press the PTT.

You see:
The preprogrammed name or ID is alternating on the LCD.

Call In Prog

8 If the Call Alert page is received,



You see:

Acknowledge

If not received,

You see:

No Acknowledge

- 9  to return to
 –or–
 Hold down  to exit Menu Mode.
- Call Alert

RECEIVING A CALL ALERT PAGE

When you receive a Call Alert page:

- The LCD screen displays  and the pre-programmed name or ID of the calling radio.
- You hear four alert tones, either once or continuously, as programmed by your dealer.



To answer the page, press the **PTT** button; to cancel the page, press any other key.

Note: Your radio displays only the last Call Alert page received. Your radio places all Selective Calls into the Call Stack until you clear the page. For more information please refer to Call Stacking (see page 17).

RADIO CHECK

Radio Check allows you to determine if a radio is within range and turned on, without disturbing the user of that radio. This feature can also be used when attempts with Selective Call and Call Alert fail.

To perform a Radio Check:

- 1  to enter Menu Mode.
- 2  until

Radio Call
- 3  to select

Radio Call
- 4  until

Radio Check
- 5  to select

Radio Check
- 6  to locate the desired ID in the Radio Call List.
 –or–
 Enter the ID number of the radio you are checking.

7 Press the **PTT** button.

You see

Call in Prog

8 If the Call Alert page is received,
you see

Acknowledge

If not received,

you see

No Acknowledge

9  to return to

—or—

Radio Check

Hold down  to exit Menu Mode.

SENDING A STATUS

This feature enables you to send a status update to the base. The status feature makes more efficient use of the channel compared to voice transmissions. Status updates of up to 14 characters may be programmed by your dealer.

To send a Status:

1  to enter Menu Mode.

2  until

Status

3  to select

Status

4  to locate the desired status in the preprogrammed list.

—or—

Press the button that has been preprogrammed for a specific status to jump to and select from the list shown on the display.

For example, pressing ,

you see:

Status

Loc 2

After 3 seconds, the selected status is shown at the top of the display and,

you see



- 5 Press the **PTT** button to make the call.

you see

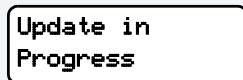

Note: You cannot retransmit the current status update.

SENDING A MESSAGE

This feature allows you to send and receive preprogrammed messages. Data messages make more efficient use of channels compared to voice transmissions. Messages of up to 14 characters may be programmed by your dealer.

To send an electronic (data) message:

1  to enter Menu Mode.

2  until

Message

3  to select

Message

4  to locate the desired message in the preprogrammed list.

–or– when using the enhanced keypad microphone only, of the message you wish to send.

–or– if programmed by your dealer (see page 11),

press the button that has been preprogrammed for a specific message.

RECEIVING A MESSAGE

When your radio receives a message:

- You hear two alert tones.
- The LED indicator flashes yellow.
- The LCD screen programmed by your dealer displays:

Msg Received

alternating with the preprogrammed alias.

Note: If you receive a message that is not programmed into your radio, the display alternates with the following:

Msg #_

and

No Alias



SENDING AN EMERGENCY ALERT

Emergency Alert can be programmed on the orange top button by your dealer. This feature allows you to send a priority Emergency Alert to a specific radio or dispatch center.

Note: Emergency Alert has priority over all other calls in conventional mode. In LTR mode, the emergency alert is sent if the system is available.

The  symbol appears on the LCD screen when your radio is in the Emergency Alert state.

An Emergency Alert can be programmed to do one of the following:

- show  and sound a tone
–or–
- show  (silent Emergency)
–or–
- activate the microphone so that all activity can be transmitted (for a programmed amount of time).

To activate the Emergency Alert, press the **Emergency** button.

To cancel the Emergency Alert, press and hold down the **Emergency** button.

CALL STACKING

Call Stacking allows you to track Call Alerts, Voice Selective Calls, and message packets that you received while on another call or away from your radio.

 appears on your LCD screen when Call Stacking is activated.

When the Call Stack contains at least one entry,  displays solid on your LCD screen.

When the call stack is full,  displays flashing on your LCD screen.

To view your missed calls:

1  to enter Menu Mode.





2  until 

3  to select 

4  until 

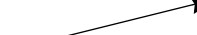
5  to select 

6  to view the missed calls.

Display shows 
New # 
New Call 
Call Type 
Time Stamp 

where the call types can be:

SC = Selective Call

CA = Call Alert

MA = Message Alert

The display also shows the Caller ID or alias for the call.

7  to delete all entries (optional).

8  to return to 
-or-

Hold down  to exit Menu Mode.

Note: If programmed by your dealer, your radio can also list the number of calls that were missed, in the status area on your display. This is a convenient way to let you know you have missed calls without having to enter the Radio Call menu.

EDITING A RADIO CALL LIST

Your radio has a Radio Call list that contains the names and radios IDs of several talkgroups or individuals.

The ID numbers in your Radio Call List are programmed by your dealer, and cannot be changed from your radio. However, you can edit the names associated with these IDs. The  symbol appears on the LCD screen when you are editing.

Note: The radio cannot receive any calls while you are editing.

To edit a Call List entry:

1  to enter Menu Mode.

2  until

Program Lists

3  to select

Program Lists

4  until

RadioCall List

5  to select

RadioCall List

6  until

Edit Entry?

7  to select

Edit Entry?

8  until you locate the desired entry.

9  to select the entry.

10 Use your keypad to edit the entry (see page 15).

11  to select

Edit Entry?

12  to return to

–or–

Edit Entry?

Hold down  to exit Menu Mode.

REPEATER OR TALKAROUND |→| MODE (CONVENTIONAL OPERATION ONLY)

Talkaround Mode enables you to communicate with another radio when either:

- The repeater is not operating
—or—
- Your radio is out of the repeater's range but within communicating distance of another radio.

Note: The |→| symbol will appear on the LCD screen when Talkaround Mode is selected.

To select either Repeater Mode or Talkaround Mode:

Press the preprogrammed Repeater/Talkaround button (see page 11) to toggle between repeater mode and talkaround mode.

—or—

1  to enter Menu Mode.

2  until

Rptr/Talkarnd

3  to select

Rptr/Talkarnd

4  until

Repeater Mode

or until

Talkarnd Mode

5  to confirm your selection.

SETTING TIGHT OR NORMAL SQUELCH

Use this feature to filter out nuisance (unwanted) calls and/or background noise. However, tightening squelch could cause calls from remote locations to be filtered out as well. In this case, normal squelch may be more desirable.

To select tight or normal squelch:







Press the preprogrammed **Squelch** button (see page 11) to toggle between tight and normal squelch,

—or—

Squelch

Do the following:

1  to enter Menu Mode.

- 2  until Utilities
- 3  to select Utilities
- 4  until Squelch
- 5  to select Squelch
- 6  until Sqlch Tight
or until Sqlch Normal
- 7  to confirm your selection.

SETTING THE POWER LEVEL

Each channel in your radio has a predefined transmit power level that can be changed.

- *High power (H)* allows you to reach a radio that is farther away.
- *Low power (L)* conserves the battery's charge.
- *Auto power* (conventional operation only) automatically sets the optimal power level based on the strength of the signal

received. If the received signal is weak, the transmit level will be set to high, and vice-versa.





Note: Be aware that a message received from a nearby radio might change your radio's power level to low. This may cause radios that are farther away not to receive your transmissions.

To set the power level:

Press the preprogrammed **Power Level** button (see page 11) to toggle between *low* and *high*,

–or–

Do the following:

- 1  to enter Menu Mode.
- 2  until Utilities
- 3  to select Utilities
- 4  until Power Level
- 5  to select Power Level

The display shows the current power level.

- 6  until Power High
- or until Power Low
- or until Power Auto

7  to confirm the selection.



NAME AND CALL ALERT TONE TAGGING

You can program your radio to sound a particular alert tone when a specific user is calling (name tone tagging), or when receiving a particular type of radio call (call tone tagging).

Note: Name and call tone tagging are valid only for selective calls and call alerts.

There are seven alert tones to select from (see page 74).

To tag a specific user's name:

- 1  to enter Menu Mode.
- 2  until Audio/Tones

3  to select Audio/Tones

4  until Name Tone Tag

5  to select Name Tone Tag

6  until you see the name you want to tag.

7  to confirm the selection.

8  until you see and hear the tone you want to use for this name.

9  to confirm the selection.











You see Name Tag Set

10  to return to Name Tone Tag

–or–

Hold down  to exit Menu Mode.

To tag a type of radio call:

- 1  to enter Menu Mode.
 - 2  until Audio/Tones
 - 3  to select Audio/Tones
 - 4  until Call Tone Tag
 - 5  to select Call Tone Tag
 - 6  until you see the call type you want to tag.
 - 7  to confirm the selection.
 - 8  until you see and hear the tone you want to use for this type of call.
 - 9  to confirm the selection.
You will see Call Tone Set
 - 10  to return to Call Tone Tag
-or-
Hold down  to exit Menu Mode.
-

SPECIAL CALLS

STATUS CALLS

A status is a code for transmitting prearranged messages; for example, status "04" could indicate "On Break."

Making a Status Call

You can make a Status Call in two ways:

- Using the preprogrammed **Status Call** button (see page 11)
- Using the **menu**

To make a status call using the Status Call button:

- 1 Press the preprogrammed **Status Call** button, such as **(P1)**.

The display shows

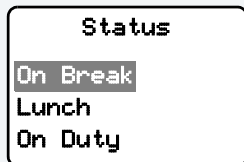

The selected status message is the first status down on the display.

- 2  to locate the desired status in the preprogrammed list.



—or—

Press the button that has been preprogrammed for a specific status to jump to and select from the list shown on the display.

For example, pressing **(2abc)**,

you see:

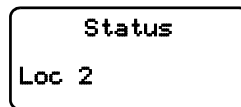

After 3 seconds, the selected status is shown at the top of the display and,

you see



- 3 Press the **PTT** button to make the call.

you see



Update in
Progress

Note: You cannot retransmit the current status update.

To make a status call using the menu:

- 1  to enter Menu Mode.

- 2  until



Status

- 3  to select



Status

- 4  to locate the desired status in the preprogrammed list.

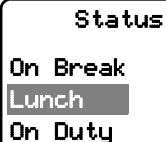

Status
On Break
Lunch
On Duty

—or—

Press the button that has been preprogrammed for a specific status to jump to and select from the list shown on the display.

For example, pressing ,

you see:

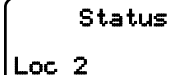

Status
Loc 2

After 3 seconds, the selected status is shown at the top of the display and,

you see

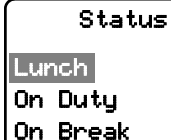

Status
Lunch
On Duty
On Break

- 5 Press the **PTT** button to make the call.

you see



Update in
Progress

Note: You cannot retransmit the current status update.

Receiving a Status Call

When your radio receives a status call:

- The radio sounds a long, low tone.
- Every 2 seconds the display alternates between either the status message or status number and the alias/number of the radio that made the status call.

Note: Only the status number is displayed if its associated message is not programmed into your radio.

EMERGENCY CALLS

An emergency call takes precedence over all other calls. This feature is available in both conventional and LTR modes of operation. However, please note that in trunked mode, this function is dependent of the availability of the system or the way the feature is set up in the programming software.

Your radio can be programmed for a one-button quick access to call a particular radio or center (preprogrammed by your dealer) in emergency situations.

You can also dial a number, using ***** **9wxyz** ***** to designate it as an emergency number.

To make an emergency call:

- 1 Press the preprogrammed **Emergency** button (see page 10).

–or–

***** **9wxyz** *****, followed by the radio number. Then, press the **PTT** button or **#**.

- 2 The radio sounds a long, low tone.

You see

Emergency

An emergency call is no longer sent:

- When the **Clear** button is pressed.
- When the radio is switched **Off** and **On** again.
- When the emergency time duration is reached. (The emergency time duration is preprogrammed into your radio by your dealer.)

When your radio receives an emergency call:

- The radio sounds a long, low tone or a ring tone, and
- You see: Emergency

PRIORITY CALLS

A priority call allows you to gain priority over other system users when requesting a call.

To make a priority call:

1 * 8 tuv *, followed by the number of the radio you are calling.

2 Press the **PTT** button or #.
The radio sounds a long, low tone.

You see:

Emergency

BROADCAST CALLS

A broadcast call allows you to make calls to a group of radios.

Note: On a broadcast call, only the calling radio can talk. There is no indication that any radios in the group have received the call.

To make a broadcast call:

1 * 1 1 *, followed by the radio group number.

2 Press the **PTT** button or #.
The radio sounds a long, low tone.

You see

*11*XX

(where “XX” represents the radio group number)

DTMF

DTMF (Dual Tone Multi Frequency), is used when a radio must operate in a radio system with an interface to telephone systems.

A system-dependent access code is normally needed for DTMF. Please contact your dealer or network manager for further information on access codes.

To make a DTMF call:

- 1 Enter the DTMF access code.
- 2 Press and hold the **PTT** button.
- 3 Enter the desired number.

Notes

SCAN

Your radio is equipped with the Scan feature, which allows you to search for, lock onto, and monitor voice activity on trunked talkgroups and conventional channels.

There are three types of Scan available in your radio:

- Auto Group Scan
- All Group Scan
- System Scan

TALKBACK

When activity is detected during any type of scan, scanning stops and the active talkgroup or channel appears and remains on the display until scanning resumes. Your dealer can program the amount of time you can respond (or “TALKBACK”) to the caller before your radio resumes scanning.

You must press the **PTT** button to participate in the call; otherwise, scanning continues to the other talkgroups or channels.

AUTO GROUP SCAN (LTR TRUNKED OPERATION ONLY)



Auto Group Scan automatically scans talkgroups within an LTR zone as programmed by your dealer. Auto Group Scan can be either non-prioritized or prioritized.

- Non-prioritized Auto Group Scan automatically scans all talkgroups programmed with Auto Group Scan.
- Prioritized Auto Group Scan automatically scans the selected talkgroup and all lower 4-numbered talkgroups. For example, if talkgroups 1, 3, and 4 have been programmed by your dealer with Auto Group Scan and talkgroup 4 is selected, the radio automatically scans talkgroups 1, 3, and 4, and skips talkgroup 2.

To start Auto Group Scan:

Select a talkgroup that has been programmed for Auto Group Scan by your dealer.

Note: You do not need to press a preprogrammed **Scan** button.

- The  symbol appears on the LCD screen when non-prioritized Auto Group Scan has been activated.
- The  symbol appears on the LCD screen when prioritized Auto Group Scan has been activated.
- There is no LED indicator during Auto Group Scan.

To stop Auto Group Scan:

Select a talkgroup that has not been programmed for Auto Group Scan by your dealer.

ALL GROUP SCAN (LTR TRUNKED OPERATION ONLY)

All Group Scan scans all talkgroups within the selected LTR trunked zone.

When All Group Scan is enabled:

- The  symbol appears on the LCD screen.
- The LED indicator blinks green during All Group Scan operation; it stops blinking when the radio switches to an active talkgroup.

Note: If you enter menu mode while the radio is scanning, scanning stops. It resumes when you exit menu mode.

To start or stop an All Group Scan operation through the menu (see page 11):

- Press the preprogrammed All Group Scan button once to start All Group Scan.
- Press the preprogrammed All Group Scan button again to stop All Group Scan.

–or–

To start or stop All Group Scan operation through the menu:

1  to enter Menu Mode.

2  until

All Group Scan

3  to select

All Group Scan

You see the current scan status.

4  until

All Group On?

–or–

All Group Off?

5  to confirm your selection.

SYSTEM SCAN (LTR AND CONVENTIONAL OPERATION)

System Scan scans trunked talkgroups and conventional channels between LTR and conventional zones, as programmed by your dealer. Up to 16 different talkgroups or conventional channels can be programmed into each Scan list. You can edit these lists through your radio's menu (see page 50).

When System Scan is enabled:

- The  symbol appears on the LCD screen.
- The LED indicator blinks green during System Scan operation; it stops blinking when the radio switches to an active talkgroup or channel.

Note: If you enter menu mode while the radio is scanning, scanning stops. It resumes when you exit menu mode.

To start or stop a System Scan operation:

Press the preprogrammed **Scan** button (see page 11) to start or stop scanning,

–or–

Do the following:

1  to enter menu mode.

2  until

System Scan

3  to select

System Scan

You see the current scan status.

4  until

Sys Scan On?

–or–

Sys Scan Off?

5  to confirm your selection.

DELETING A NUISANCE CHANNEL/ TALKGROUP (SYSTEM SCAN OPERATION ONLY)

If a talkgroup or channel continually generates unwanted calls (a “nuisance” channel), use the preprogrammed **Scan** button to temporarily delete the talkgroup or channel from the Scan list.

To temporarily delete the channel/ talkgroup:

- 1 While the radio’s receiving activity is on the nuisance channel, press and hold the **Scan** button until you hear a high-pitched tone (valid key press).
- 2 Release the **Scan** button. The nuisance channel has been temporarily deleted from your Scan list.

Restoring a Channel/Talkgroup Back to the Scan List

To restore a previously deleted talkgroup or channel back to the Scan list, restart the scan operation or turn your radio off and on again.

EDITING A SCAN LIST (SYSTEM SCAN OPERATION ONLY)

One Scan list is assigned to each of the 16 positions on the **Zone/Channel Selector** knob. Each Scan list can contain up to 16 talkgroups and/or channels. The same talkgroup or channel can be included in several Scan lists, and the same Scan list can be assigned to several **Zone/Channel Selector** positions.

When you edit a Scan list, you can either add, delete, or prioritize talkgroups or channels:

Position 2	Position 2
1	1
3	2
5	3
6	11

Your radio cannot receive any calls while you are editing a scan list. displays while you are in edit mode.

Note: In Conventional operation only, even if there is activity on a non-priority channel, your radio automatically switches to an active priority channel and indicates the activity with a short tone.

ADDING OR DELETING CHANNELS OR TALKGROUPS IN A SCAN LIST

1  to enter Menu Mode.

2  until

Program Lists

3  to select

Program Lists

4  until

Scan List

5  to select

Scan List

6  until

Add Entry?

–or–

Delete Entry?

7  to confirm your selection.

8  until you see the channel/talkgroup you want to add or delete.

Note: You cannot delete the last remaining channel of a scan list.

9  to confirm your selection.

10 If you added a channel or talkgroup,
you see

Entry Saved?

–or–

If you deleted a channel or talkgroup,
you see

Delete?

 to confirm the deletion.

you see

Entry Deleted

11 (to return to

Select Contact

or to return to

Delete Entry

–or–

Hold down  to exit Menu Mode.











PRIORITIZING A CHANNEL/ TALKGROUP IN A SCAN LIST

You may want to check the activity on one or two channels more frequently than others. You can do this by prioritizing them:

Priority Channel	Scanning Sequence
None specified	Ch1 → Ch2 → Ch3 → Ch4 → ... Ch1
Channel 2 (Priority 1)	Ch2 → Ch1 → Ch2 → Ch3 → Ch2 → Ch4 → Ch2 → ... Ch1
Channel 2 (Priority 1) and Channel 8 (Priority 2)	Ch2 → Ch1 → Ch8 → Ch3 → Ch2 → Ch4 → Ch8 → ... Ch1

Note: Even if there is activity on a non-priority channel, your radio will automatically switch to an active priority channel and indicate the activity with a short tone.

Setting Priority Channels or Talkgroups

- 1  to enter Menu Mode.
 - 2  until Program Lists
 - 3  to select Program Lists
 - 4  until Scan List
 - 5  to select Scan List
 - 6  until Edit Priority?
 - 7  to select Edit Priority?
 - 8  until Priority #1
 - or-
 - Priority #2
- You see the current priority talkgroup or channel.
- 9  to select the desired priority level.
 - 10  until you see the channel you want to prioritize.

11  to prioritize that channel.

12  to return to

Edit Priority?

–or–

Hold down  to exit Menu Mode.

Note: You cannot reprioritize a Priority 1 channel or talkgroup to Priority 2. If you want to reprioritize all channels or talkgroups, you must delete each priority channel from the scan list and add it back.

Notes

PHONE

Your radio allows you to place and receive telephone calls through trunked and conventional systems (depending on phone line availability). Telephone calls through a repeater allow only one person to speak at a time.

MAKING A PHONE CALL THROUGH AN LTR SYSTEM

Note: The following instructions assume your radio has been programmed as follows by your dealer using CPS (Customer Programming Software).

- Dial type: Live
- Access/Deaccess type: Immediate Auto
- Tone Span: Timed - 100 ms tone duration

To initiate a phone call:

Do the following:

- 1 Select a trunked zone and talkgroup that have been programmed for telephone.

- 2  to enter menu mode.

–or–

Press the preprogrammed **Phone** button, and skip to step 5.

–or–

Press and release the **Speed Dial** button to use the speed dial feature. Then press the (1 to 9) key corresponding to the number you want to call on the Phone list. Or press 0 if you want to call the last number dialed. Press the **PTT** button. A dial tone sounds. Press the **PTT** button again to send the phone number.

–or–

Press and hold the **PTT** button while dialing a number. (If your radio has been programmed for Hot keypad, this is a radio-wide setting).

- 3  until

Phone

- 4  to confirm

Phone

 appears on the LCD screen when you are in Phone mode.

- 5 Press and Release the **PTT** button.
- If phone access is successful, a dial tone sounds.
 - If phone access is unsuccessful, a low-pitched alternating tone sounds. Disconnect the call (see step 8) and try again.

- 6 Enter the phone number with the keypad. The number is automatically sent without pressing the **PTT** button again.

–or–



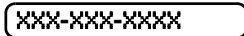

to select a number from the phone list.



Press and release the **PTT** button again to send the number.

- 7 Hold the radio in a vertical position with the microphone 1 to 2 inches (2.5 to 5 cm) away from your mouth. Press the **PTT** button to talk; release it to listen.

- 8 To disconnect the phone call: Press and hold  to exit Phone.  no longer appears on the LCD.

MAKING A PHONE CALL THROUGH A CONVENTIONAL SYSTEM

To initiate a phone call:

Press the preprogrammed **Phone** button, and skip to step 5.

–or–

Press the **PTT** button, and if the Hot keypad feature has been programmed by your dealer, do the following:

- 1 Select a conventional zone and channel that have been programmed for telephone.

- 2  to enter menu mode.

- 3  until

Phone

- 4  to select

Phone

 appears on the LCD screen when you are in Phone Mode.

- 5 (For conventional operation with auto access only). You hear a series of tones, indicating that an access code is being sent automatically, and see your access code:

–or–

Enter your access code using the keypad.

- 6 When you hear a dial tone:

Enter the phone number using the keypad.

XXX-XXX-XXXX

–or–

Enter Phone #

 to select a number from the phone list.

XXX-XXX-XXXX

–or– (see step 7)

- 7 a) Press and release the preprogrammed **Speed Dial** button (see step 2 on page 55) to use the Speed Dial feature.

- b) Press the key (1 to 9) corresponding to the number you want to call, or press 0 if you want to call the last number dialed.

Note: To redial the last number dialed (if not using Speed Dial), press and release the **PTT** button immediately after the access code is sent. The radio sends the last number dialed.

–or–

If you entered your access code using the keypad, press the  key once to access the last number dialed; then press and release the **PTT** button.

- 8 Press and release the **PTT** button, if required for your radio.

- 9 Hold the radio in a vertical position with the microphone 1 to 2 inches (2.5 to 5 cm) away from your mouth. Press the **PTT** button to talk; release it to listen.

- 10 To disconnect a phone call, do one of the following:
Enter the deaccess code using the keypad.
—or—
If your radio has the deaccess code programmed, go to step 9.

- 11 To exit Phone Mode:
Press and hold **#** to disconnect the call.
ⓘ disappears from the LCD.

RECEIVING A PHONE CALL ⓘ THROUGH AN LTR OR CONVENTIONAL SYSTEM

To receive a phone call:

- 1  to select an LTR talkgroup or conventional channel that has been programmed for telephone.
—or—
Activate any scan type containing a telephone talkgroup or channel.
 - When a phone call is received, a ringing tone sounds, alerting you to answer the phone call.
- 2 Press the **PTT** button to answer the phone call. Press the **PTT** button to talk; release it to listen.
- 3 To disconnect the phone call and exit Phone and menu mode:
Press and hold to disconnect the call.











MODIFYING THE PHONE LIST









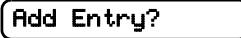





Your radio contains a Phone list that holds up to 25 phone numbers. The Phone list is shared between trunked and conventional Phone operation. You can modify the Phone list in three ways through your radio's menu:

- Add an entry
- Delete an entry
- Edit an existing entry





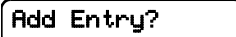



 appears on the LCD screen when you are modifying the phone list.



To Add an Entry:

- 1  to enter menu mode.
- 2  until 
- 3  to select 
- 4  until 
- 5  to select 
- 6  until 









- 7  to select 
- You see: 
- 8 Use the keypad to enter the name (see page 15) .
- 9  to store the name.
You see: 
- 10 Use the keypad to enter the phone number. You can also add a dash (press ) and a Pause Indicator (hold down  until the # character on the LCD screen changes to a "P").
- 11  to store the phone number.
- 12  until you see the location in the list where you want to store the phone number.
- 13  to store the phone number.
You see: 
- 14  to return to 
Hold down  to exit Menu Mode.

To Delete an Entry:

- 1  to enter menu mode.
- 2  until Program Lists
- 3  to select Program Lists
- 4  until Phone List
- 5  to select Phone List
- 6  until Delete Entry?
- 7  to select Delete Entry?
- 8  until you see the entry you want to delete.
- 9  to select the entry.
- 10 You see: Delete?
 again to confirm the deletion.
 You see: Entry Deleted

- 11  to return to Delete Entry?
-or-
 Hold down  to exit Menu Mode.

To Edit an Entry:

- 1  to enter Menu Mode.
- 2  until Program Lists
- 3  to select Program Lists
- 4  until Phone List
- 5  to select Phone List
- 6  until Edit Entry?
- 7  to select Edit Entry?
- 8  until you see the entry you want to edit.
- 9  to select the entry.

10  until
(to edit the name), **Edit Name?**

–or– until
(to edit the phone
number), **Edit Number?**

–or– until **Edit Location?**
(to edit the location in the phone list).

11  to confirm your selection.

12 Use the keypad to edit the entry (see page
15), –or–

 until you see the location where you want
to store the phone number.

13  to store the information.

14  to return to **Edit Entry?**
–or–

Hold down  to exit Menu Mode.

Notes

VOICE STORAGE

The HT1550•XLS radio's voice storage feature enables your radio to perform seven types of voice related functions:

- All Incoming Call Recording
- Voice Memo Recording
- Recorded Message Playback
- Recorded Message Delete
- Recorded Message Transmission
- Automatic Message Reply ("When Available")
- Message Time Stamping

There is a total of 120 seconds recording time available for all voice storage activity. Your dealer can divide the 120 seconds into a defined number of equal length time slots. The following table summarizes the slot length options available with the HT1550•XLS radio:

Number of Equal Length Slots	Slot Length (Seconds)
1	120
2	60
5	24
10	12
20	6

When recording calls, keep in mind these time slot guidelines:

- As a time slot becomes close to full, you see a timer count down the final 5 seconds.

When a time slot is completely full, an alert tone sounds

The LCD screen shows:

Msg Slot Full

Recording stops.

- When all message slots have at least one message stored, an alert tone sounds.

If a voice storage record function is requested, the LCD screen shows:

Memory Full

INCOMING CALL RECORDING

The HT1550•XLS radio allows you to record incoming calls in either of two ways:

- Selective Incoming Call Recording
- All Incoming Call Recording

Note: Only the audio transmissions of your caller are recorded.

Selective Incoming Call Recording

This feature enables you to record incoming calls selectively, or on a call-by-call basis.

To Selectively Record an Incoming Call:

- 1 Press and hold the preprogrammed **Record/Playback** button (see page 11) while receiving the call.

The display shows

Recording

A confirmation tone sounds, indicating that the radio begins recording.

- 2 The radio records the call until the message slot is full or until you release the preprogrammed **Record/Playback** button.

- 3 Release the **Record/Playback** button to stop recording.













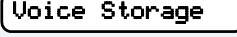

All Incoming Call Recording

This feature enables you to automatically record all incoming trunked and conventional dispatch calls, trunked and conventional telephone interconnect calls, and MDC selective calls.

This feature is useful when you need to keep informed of channel activity while away from your radio.

Note: This feature does not work while in Scan mode.

To Record All Incoming Calls:

- 1  to enter menu mode.
- 2  until 
- 3  to select 
- 4  until 
- 5  to select 
- 6  until 
- 7  to select 
- 8 The display continuously flashes, except while a call is being recorded. 

- 9 While your radio is recording,

you see:



The radio also records the time stamp and the channel alias to the message slot.

- 10 Press  to stop recording.

–or–

Go to step 1 again to continue recording in the next available slot.

Note: Five seconds before the message



slot ends, the radio display shows

(where XX = remaining seconds).

The “voice storage full” alert sounds when the message slot is full, and recording stops.

You see:

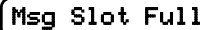

VOICE MEMO RECORDING

In addition to recording calls received, the HT1550•XLS radio offers you the ability to record voice memos (or personal reminders) into the radio. The voice memo recording feature is useful for quickly saving phone numbers, names, or any other brief voice information. You can record voice memos using the preprogrammed **Record/Playback** button (see page 11) or your radio's menu.

Important Note:















To record properly, incoming calls cannot be received while a voice memo is being recorded.

To record a voice memo using the preprogrammed Record/Playback button:

- 1 Press and hold the preprogrammed **Record/Playback** button.
 - The display shows:  **Recording**
 - A confirmation tone sounds, indicating that the radio begins recording.

- 2 Without pressing the **PTT** button, speak clearly into the microphone to record your memo. The radio records your memo until the message slot is full or until you release the preprogrammed **Record/Playback** button.
- 3 Release the **Record/Playback** button to stop recording.

To record a voice memo using the menu:

- 1  to enter menu mode.
- 2  until  **Voice Storage**
- 3  to select  **Voice Storage**
- 4  until  **Record**
- 5  to select  **Record**
- 6  or  until  **Voice Memo**
- 7  to select
You see:  **Recording**

- 8 Without pressing the **PTT** button, speak clearly into the microphone to record your memo. The radio records your memo until the message slot is full or until you press .

Note: To stop recording at any time, press (.

- 9 Press  to stop recording.

–or–

Repeat steps 7 and 8 to store additional messages.

RECORDED MESSAGE PLAYBACK

The HT1550•XLS allows you to list, select, and Playback previously recorded incoming call or voice memo messages. You can play back a message by using the preprogrammed **Record/Playback** button (see page 11) or your radio's menu.

Note: Recorded message **Playback** cannot be initiated while your radio is receiving. Also, you don't receive any incoming calls while you play back messages.

To play back a message using the preprogrammed **Record/Playback** button:

- 1 Press and release the preprogrammed **Record/Playback** button.

- The first message plays, and the display shows (XXX = the message number)

Playing Msg XXX

- 2 To advance to the next message at any time during Play back, press and release the **Record/Playback** button again.















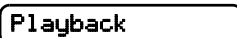

- 3 **To exit/cancel Play Back mode:**

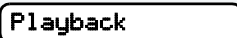
Press and release the preprogrammed **Playback Exit** button (see page 11).

–or–

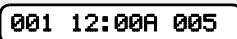
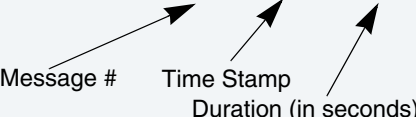
Press  to stop Play Back.

To playback a message using the menu:



- 1  to enter menu mode.
- 2  until  **Voice Storage**
- 3  to select  **Voice Storage**
- 4  until  **Playback**
- 5  to select  **Playback**
- 6  until  **001 12:00A 005**
- 7  to select  **001 12:00A 005**

- 8  to select the desired message.
- 9 Press  to play the selected message.
- 10  anytime during playback to advance to the next message.

RECORDED MESSAGE DELETE

The HT1550•XLS radio allows you to delete previously recorded incoming call or voice memo messages. You can delete a message using either the preprogrammed **Record/Playback** button (see page 11) or your radio's menu.

Note: Messages must be deleted one at a time.

To delete a message using the preprogrammed Record/Playback button (see page 11):

- 1 Press and release the preprogrammed **Record/Playback** button.
- 2  to select the desired message.
- 3 Press and hold the preprogrammed **Record/Playback** button to delete current message.
- 4  to stop deleting messages.

To delete a message using the menu:

1  to enter menu mode.

2  until 

3  to select 

4  until 

5  to select 

6  to select the desired message.

7 Press  to delete the selected message.

8  to select the another message to be deleted, then go to step 7.

—or—

Press  to stop deleting messages.

RECORDED MESSAGE TRANSMISSION

This feature allows you to transmit a recorded message to another radio user.







To transmit a recorded message:

- 1 Press and hold the **PTT** button to initiate the message transmission.
- 2 While holding down the **PTT** button, press the preprogrammed **Record/Playback** button to select and play back the desired recorded call or memo.
- 3 When finished transmitting your message, press the **Record/Playback** button again to stop transmitting.





AUTOMATIC MESSAGE REPLY: “WHEN AVAILABLE”

The automatic Message Reply feature allows you to transmit a recorded message to a caller when your radio receives an MDC selective call.











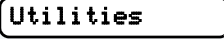

To enable the Automatic Message Reply feature:

- 1  to enter menu mode.
- 2  until Utilities
- 3  to select Utilities
- 4  until When Available
- 5  to select When Available
- 6  until AutoReply On?
- 7  to select

To record a message:

- 1  until Recorded Msg
 - 2  to select Recorded Msg
- you see: Recording
- 3 Without pressing the **PTT** button, speak clearly into the microphone to record your memo. The radio records your memo until the message slot is full or until you press .
 - 4 To exit or cancel recording, press .
- With this feature enabled, the recorded message is automatically transmitted whenever your radio receives an individual call.

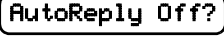







To disable the Automatic Message Reply feature:

- 1  to enter menu mode.
- 2  until 
- 3  to select 
- 4  until 
- 5  to select 
- 6  until 
- 7  to select

Notes

AUDIO/TONE SETTINGS

You can customize the audio and tone feature settings on your radio by:

- 1  to enter Menu Mode.
- 2  until 
- 3  to select 
- 4  until you see the feature you want to change (see the following table).
- 5  to select the feature. You see the feature's current setting.
- 6  for available settings. (For Name and Call Tone Tagging, see page 39.)
- 7  to select the desired setting.

Audio/Tone Settings

Feature	What it Does	Settings
Alert Vol Lvl	Makes the volume level of the audio and alert tones independent. If turned on it makes the alert tones follow the settings in the CPS. If turned off, the alert tones follow the setting of the volume knob.	Ind Alert Off Ind Alert On
Tone Disable	Turns all tones on or off.	Tones On Tones Off
Name and Call Alert Tone Tagging	Assigns a specific ring tone when receiving a call from a specific user (see page 39 for details).	Standard Alert #1 – #7
Call Tone Tag	Assigns a specific tone when receiving a specific type of radio call (see page 40 for details).	Standard Alert #1 – #7
Escalert	Increases the volume of the alarm tones when a call is not answered.	Escalert On Escalert Off
Companding	Provides the same audio quality for 12.5 kHz channels as for 25 kHz channels.	Compand On Compand Off
Keypad Tones	Turns keypad tones on or off except for programmable buttons.	Tones On Tones Off

UTILITIES

You can customize some of your radio's feature by:

1  to enter menu mode.

2  until

Utilities

3  to select

Utilities

4  until you see the feature you want to change (see table on the next page).

5  to select the feature. You see the feature's current setting.

6  or Channel/Zone Menu Selector knob for available settings.

7  to select the desired setting.

Utilities Features

Feature	What it Does	Settings
Radio Lock	Sets Radio Lock password or turns the Radio Lock option on or off (see page 25).	Radio Lock On Radio Lock Off Change Password
Squelch §	Sets radio squelch at either normal or tight (see page 37).	Sq1ch Normal Sq1ch Tight
Power Level	Changes the power level of the radio to high, low, or auto (see page 37).	Power High Power Low Power Auto
Clock	Sets the time, or turns the clock on or off (see page 78).	Clock On Clock Off Set Time
Reminder Alarm	Sets the alarm, or turns it on or off (see page 78).	Alarm On Alarm Off Set Time
Language Selection	Selects the language to be shown in your radio's displays.	English Spanish Portuguese French
Option Board	Activates/deactivates the option board installed in your radio.	Opt Board On Opt Board Off

Utilities Features

Feature	What it Does	Settings
Light Disable	Turns the display and keypad backlight feature on or off.	Lights On Lights Off
Software Ver #	Displays the radio's software version number when you press  .	—
When Available	Transmits a recorded message to a caller when your radio receives a Selective Call.	Audio Reply On Auto Reply Off Record Msg Renew Msg

§ Conventional operation only.

SETTING THE CLOCK

To set the clock:

1  to enter menu mode.

2  until Utilities

3  to select Set Time?

4  until Clock

–or– until Reminder Alarm

5  to confirm your selection.

6  until Set Time?

7  to select Set Time?

8 When a setting is blinking, you can change it with .

Hour (AM or PM) → 3:05 PM

Minutes (AM/PM or 24 hr)

Note: You cannot select “24 hr” for

Reminder Alarm

9  to move to the next setting.

10  to save your changes.

11  to return to Utilities

–or– to return to Reminder Alarm

–or–

Hold down  to exit menu mode.

HOME CHANNEL REVERT

The Home Channel Revert feature allows you to instantly access your favorite trunked talkgroup or conventional channel at the touch of a button.

To activate Home Channel Revert:

Press the preprogrammed **Home Channel Revert** button (see page 10).

HOME REVERT AUTOKEY (LTR OPERATION ONLY)

This feature is recommended for use on LTR systems with MDC Signaling enabled.

It allows you at the touch of a button to automatically key up the radio, directly access a favorite trunked talkgroup and send a **PTT-ID** to a group of radios.

Note: The radio tries to key up for a short period of time (3s) however, you need to push the PTT if you wish to talk. If the radio does not gain access after one retry, you should receive a bad tone. If the radio reverts to a busy channel, the radio only reverts to the home channel.

Notes

WARRANTY

LIMITED WARRANTY

MOTOROLA COMMUNICATION PRODUCTS

I. WHAT THIS WARRANTY COVERS AND FOR HOW LONG:

MOTOROLA INC. (“MOTOROLA”) warrants the MOTOROLA manufactured Communication Products listed below (“Product”) against defects in material and workmanship under normal use and service for a period of time from the date of purchase as scheduled below:

HT1550•XLS Portable Units	Two (2) Years
Product Accessories	One (1) Year

Motorola, at its option, will at no charge either repair the Product (with new or reconditioned parts), replace it (with a new or reconditioned Product), or refund the purchase price of the Product during the warranty period provided it is returned in accordance with the terms of this warranty. Replaced parts or boards are warranted for the balance of the original applicable warranty

period. All replaced parts of Product shall become the property of MOTOROLA.

This express limited warranty is extended by MOTOROLA to the original end user purchaser only and is not assignable or transferable to any other party. This is the complete warranty for the Product manufactured by MOTOROLA.

MOTOROLA assumes no obligations or liability for additions or modifications to this warranty unless made in writing and signed by an officer of MOTOROLA. Unless made in a separate agreement between MOTOROLA and the original end user purchaser, MOTOROLA does not warrant the installation, maintenance or service of the Product.

MOTOROLA cannot be responsible in any way for any ancillary equipment not furnished by MOTOROLA which is attached to or used in connection with the Product, or for operation of the Product with any ancillary equipment, and all such equipment is expressly excluded from this warranty. Because each system which may use the Product is unique, MOTOROLA disclaims liability for range, coverage, or operation of the system as a whole under this warranty.

II.GENERAL PROVISIONS:

This warranty sets forth the full extent of MOTOROLA'S responsibilities regarding the Product. Repair, replacement or refund of the purchase price, at MOTOROLA's option, is the exclusive remedy. THIS WARRANTY IS GIVEN IN LIEU OF ALL OTHER EXPRESS WARRANTIES. IMPLIED WARRANTIES, INCLUDING WITHOUT LIMITATION, IMPLIED WARRANTIES OF MERCHANTABILITY AND FITNESS FOR A PARTICULAR PURPOSE, ARE LIMITED TO THE DURATION OF THIS LIMITED WARRANTY. IN NO EVENT SHALL MOTOROLA BE LIABLE FOR DAMAGES IN EXCESS OF THE PURCHASE PRICE OF THE PRODUCT, FOR ANY LOSS OF USE, LOSS OF TIME, INCONVENIENCE, COMMERCIAL LOSS, LOST PROFITS OR SAVINGS OR OTHER INCIDENTAL, SPECIAL OR CONSEQUENTIAL DAMAGES ARISING OUT OF THE USE OR INABILITY TO USE SUCH PRODUCT, TO THE FULL EXTENT SUCH MAY BE DISCLAIMED BY LAW.

III.STATE LAW RIGHTS:

SOME STATES DO NOT ALLOW THE EXCLUSION OR LIMITATION OF INCIDENTAL

OR CONSEQUENTIAL DAMAGES OR LIMITATION ON HOW LONG AN IMPLIED WARRANTY LASTS, SO THE ABOVE LIMITATION OR EXCLUSIONS MAY NOT APPLY.

This warranty gives specific legal rights, and there may be other rights which may vary from state to state.

IV.HOW TO GET WARRANTY SERVICE:

You must provide proof of purchase (bearing the date of purchase and Product item serial number) in order to receive warranty service and, also, deliver or send the Product item, transportation and insurance prepaid, to an authorized warranty service location. Warranty service will be provided by Motorola through one of its authorized warranty service locations. If you first contact the company which sold you the Product (e.g., dealer or communication service provider), it can facilitate your obtaining warranty service. You can also call Motorola at 1-800-927-2744 US/Canada.

V.WHAT THIS WARRANTY DOES NOT COVER:

- A) Defects or damage resulting from use of the Product in other than its normal and customary manner.
- B) Defects or damage from misuse, accident, water, or neglect.
- C) Defects or damage from improper testing, operation, maintenance, installation, alteration, modification, or adjustment.
- D) Breakage or damage to antennas unless caused directly by defects in material workmanship.
- E) A Product subjected to unauthorized Product modifications, disassemblies or repairs (including, without limitation, the addition to the Product of non-Motorola supplied equipment) which adversely affect performance of the Product or interfere with Motorola's normal warranty inspection and testing of the Product to verify any warranty claim.
- F) Product which has had the serial number removed or made illegible.
- G) Rechargeable batteries if:
 - 1)any of the seals on the battery enclosure of cells are broken or show evidence of tampering.
 - 2)the damage or defect is caused by charging or using the battery in equipment or service other than the Product for which it is specified.
- H) Freight costs to the repair depot.
- I) A Product which, due to illegal or unauthorized alteration of the software/ firmware in the Product, does not function in accordance with MOTOROLA's published specifications or the FCC type acceptance labeling in effect for the Product at the time the Product was initially distributed from MOTOROLA.
- J) Scratches or other cosmetic damage to Product surfaces that does not affect the operation of the Product.
- K) Normal and customary wear and tear.

VI.PATENT AND SOFTWARE PROVISIONS:

MOTOROLA will defend, at its own expense, any suit brought against the end user purchaser to the extent that it is based on a claim that the Product or parts infringe a United States patent, and MOTOROLA will pay those costs and damages finally awarded against the end user purchaser in any such suit which are attributable to any such claim, but such defense and

payments are conditioned on the following:

- A) that MOTOROLA will be notified promptly in writing by such purchaser of any notice of such claim;
- B) that MOTOROLA will have sole control of the defense of such suit and all negotiations for its settlement or compromise; and
- C) should the Product or parts become, or in MOTOROLA's opinion be likely to become, the subject of a claim of infringement of a United States patent, that such purchaser will permit MOTOROLA, at its option and expense, either to procure for such purchaser the right to continue using the Product or parts or to replace or modify the same so that it becomes non-infringing or to grant such purchaser a credit for the Product or parts as depreciated and accept its return. The depreciation will be an equal amount per year over the lifetime of the Product or parts as established by MOTOROLA.

MOTOROLA will have no liability with respect to any claim of patent infringement which is based upon the combination of the Product or parts furnished hereunder with software, apparatus or devices not furnished by MOTOROLA, nor will MOTOROLA have any liability for the use of ancillary equipment or software not furnished by

MOTOROLA which is attached to or used in connection with the Product. The foregoing states the entire liability of MOTOROLA with respect to infringement of patents by the Product or any parts thereof.

Laws in the United States and other countries preserve for MOTOROLA certain exclusive rights for copyrighted MOTOROLA software such as the exclusive rights to reproduce in copies and distribute copies of such Motorola software. MOTOROLA software may be used in only the Product in which the software was originally embodied and such software in such Product may not be replaced, copied, distributed, modified in any way, or used to produce any derivative thereof. No other use including, without limitation, alteration, modification, reproduction, distribution, or reverse engineering of such MOTOROLA software or exercise of rights in such MOTOROLA software is permitted. No license is granted by implication, estoppel or otherwise under MOTOROLA patent rights or copyrights.

VII. GOVERNING LAW:

This Warranty is governed by the laws of the State of Illinois, USA.

ACCESSORIES

Motorola offers a number of accessories to enhance the productivity of your two-way radio. Many of the available accessories are listed below. For a complete list, see your Motorola dealer.

ANTENNAS

NAD6563	VHF whip (136–174 MHz)
NAD6566	VHF (136–150.8 MHz)
NAD6567	VHF (150.8–162 MHz)
NAD6568	VHF (162–174 MHz)
NAE6546_R	UHF (380–435 MHz)
NAE6547_R	UHF (435–470 MHz)
NAE6548_R	UHF (470–520 MHz)
NAE6549_R	UHF whip (380–520 MHz)

BATTERIES

NTN9815_R	NiCD 1525 mAh 7.5 V
-----------	---------------------

NTN9816_R	NiCD 1525 mAh 7.5 V, Intrinsically Safe
NTN9857_R	NiMH 1800 mAh 7.5 V, Intrinsically Safe
NTN9858_R	NiMH 1800 mAh 7.5 V

CARRY ACCESSORIES

Carry Cases

HLN9698	Leather DTMF Case with Belt Loop, for use with NiMH and NiCd batteries
HLN9695	Leather DTMF Case with Belt Loop, for use with Li-Ion batteries
HLN9700	Leather DTMF Case with Swivel, for use with NiMH and NiCd batteries
HLN9699	Leather DTMF Case with Swivel, for use with Li-Ion batteries

HLN9701	Nylon Case with Belt Loop for use with NiCd, NiMH, and Li-Ion batteries
NTN5243	Shoulder Strap
TDN9675	Wrist Strap

Belt Clips

HLN9714	Belt clip, 2 1/2 inch
HLN9844	Belt clip, 2 inch

T-Straps

NTN8383	T-Strap Leather Plain Action Snaps
NTN8384	T-Strap Leather Hard Action Snaps

Belt-Loops

NTN8039	Leather Swivel Belt Loop, 2.5"
NTN8040	Leather Swivel Belt Loop, 3.0"

CHARGERS

NLN7967	Wall mount for multi-unit charger
NLN7968	Rack mount for multi-unit charger
NTN1177	Multi-unit, rapid rate, 110V
NTN1667	Single-Unit, universal tri-chemistry rapid charge, 110V Tri-chemistry, 110V
WPLN4111_R	impres™ single-unit charger, 110V
WPLN4108_R	impres™ multi-unit charger, 110V

AUDIO ACCESSORIES

Microphones

NMN6191	Remote speaker microphone, noise-canceling
NMN6193	Remote speaker microphone

NNTN4285	Remote speaker mic adapter
----------	----------------------------

Headsets

BDN6635	Heavy-duty VOX headset with boom mic (requires BDN6673 adapter cable)
BDN6636	Heavy-duty VOX headset with throat mic (requires BDN6673 adapter cable)
BDN6645	Heavy-duty push-to-talk headset with boom mic (requires BDN6673 adapter cable)
NMN1020	Light-weight headset with boom mic to be worn on a helmet or safety glasses (requires BDN6676 adapter)
NMN6245	Single-muff lightweight headset with boom mic and in-line PTT (requires BDN6676 adapter)

NMN6246	Ultra-light headset with boom mic and in-line PTT; ear bud style receiver (requires BDN6676 adapter)
NMN6258	Medium-weight headset, over-the-head with in-line PTT
NMN6259	Medium-weight headset, behind-the-head with in-line PTT
RMN4049	Temple Transducer

CommPort™ Integrated Microphone Receiver System

NTN1624	CommPort with palm PTT (includes BDN6676 adapter)
NTN1625	CommPort with PTT on radio adapter (includes BDN6676 adapter)
NTN1663	CommPort with ring PTT (includes BDN6676 adapter)

NTN1736	CommPort with snap-on side PTT (includes BDN6676 adapter)
---------	---

Surveillance Kits

BDN6664	Receive only earpiece with standard earphone earloop (1-wire), beige
BDN6665	Receive only earpiece with standard earphone earloop (1-wire),exceeds OSHA limits, beige
BDN6666	Receive only earpiece with volume control (1-wire), beige
BDN6667	Earpiece with mic and PTT combined (2-wire), beige
BDN6668	Earpiece with mic and PTT separate (3-wire), beige
BDN6669	Earpiece with mic and PTT combined (2-wire), exceeds OSHA limits, beige

BDN6670	Earpiece with mic and PTT separate (3-wire), exceeds OSHA limits, beige
BDN6719	Earpad, with 3.5mm threaded plug
BDN6726	Receive only earpiece with standard earphone earloop (1-wire), black
BDN6727	Receive only earpiece with standard earphone earloop (1-wire),exceeds OSHA limits, black
BDN6728	Receive only earpiece with volume control (1-wire), black
BDN6729	Earpiece with mic and PTT combined (2-wire), black
BDN6730	Earpiece with mic and PTT separate (3-wire), black
BDN6731	Earpiece with mic and PTT combined (2-wire), exceeds OSHA limits, black

BDN6732	Earpiece with mic and PTT separate (3-wire), exceeds OSHA limits, black
---------	---

Earpieces

BDN6780	Single earbud with mic and PTT (requires BDN6676 adapter)
BDN6781	Receive only earbud (requires BDN6676 adapter)
BDN6719	Flexible ear receiver

Ear Microphone System (EMS)

BDN6677	Ear mic, standard, noise up to 95 dB (must order BDN6671 interface module), black
BDN6678	Ear mic, standard, noise up to 95 dB (must order BDN6671 interface module), beige
BDN6641	Ear mic, high noise level up to 105 dB, grey (must order BDN6671 interface module)

0180358B38	Push-to-Talk Ring Switch
0180300E83	Push-to-Talk Body Switch
0180300E25	Earguard with Adjustable Loop

Radio Interface Modules for Ear Switches

BDN6671	Push-to-talk (PTT) and voice-activated (VOX) interface module (for use with BDN6641, BDN6677 and BDN6678)
BDN6708	PTT interface module (for use with BDN6641, BDN6677 and BDN6678)

NTN7660	Tilt / man down switch
---------	------------------------

ADAPTERS

BDN6673	Headset adapter cable
BDN6676	3.5mm jack adapter with quick disconnect latch
NTN8613	Surveillance accessory adapter

Menu Navigation Chart

(Refer to Menu Navigation guidelines—
lower, left-hand corner of this page)

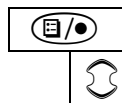

‡ — Available in LTR Trunked Zones only

§ — Available in conventional Zones only

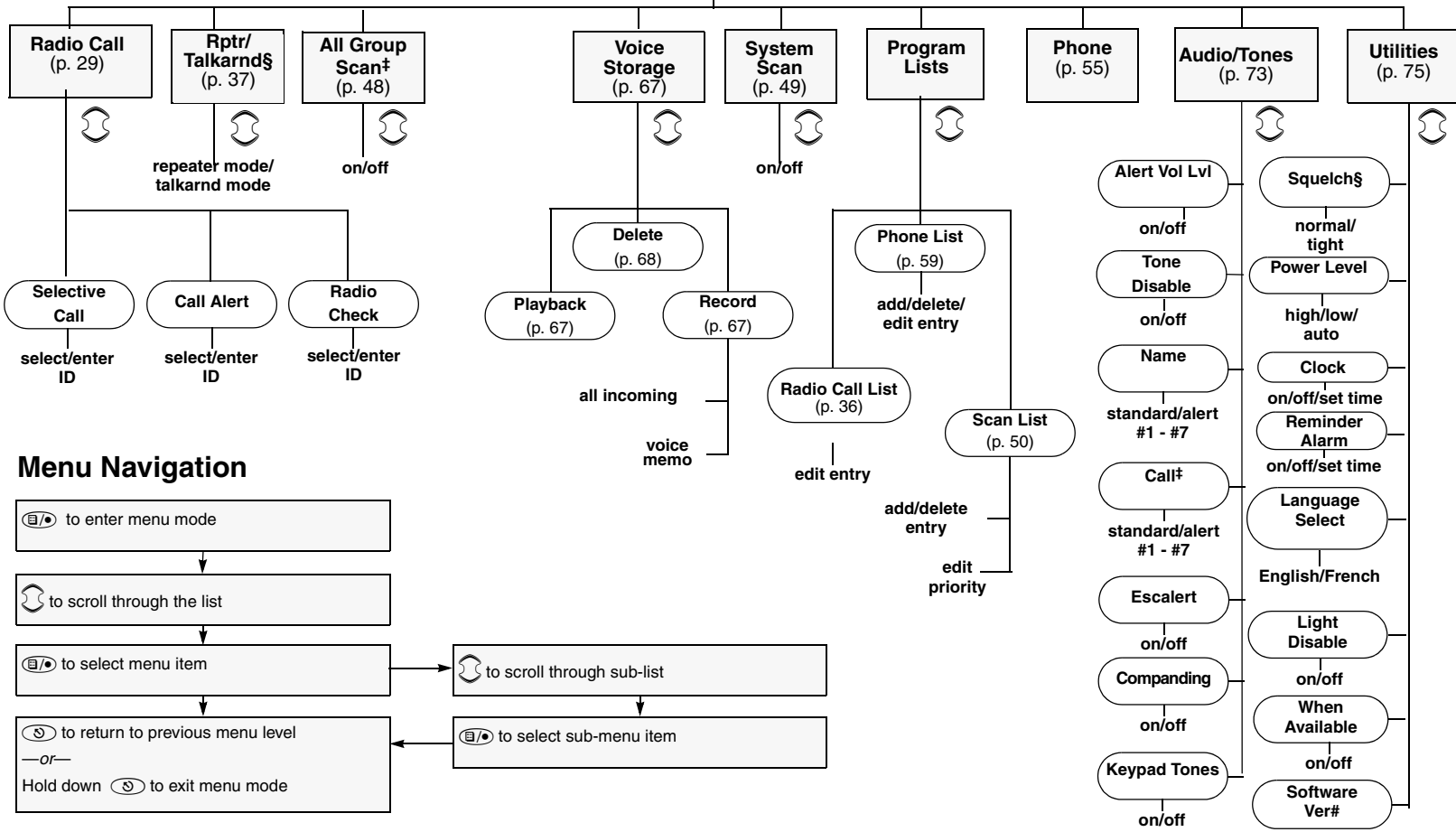

Menu Navigation

to enter menu mode

to scroll through the list

to select menu item

to scroll through sub-list

to return to previous menu level
—or—
Hold down to exit menu mode

to select sub-menu item



MOTOROLA and the Stylized M Logo are registered in the U.S. Patent and Trademark Office. All other product or service names are the property of their respective owners.
© Motorola, Inc. 2005.

MOTOROLA et le logo stylisé M sont homologués au Patent and Trademark Office des Etats-Unis. Tous les autres noms de produits ou services appartiennent à leurs propriétaires respectifs.
© Motorola, Inc. 2005.



6881093C95-A